

Maintenance Manual

M 51-01



Washington State Department of Transportation
Maintenance & Operations



Alternate Formats: Persons with disabilities may request this information be prepared and supplied in alternate formats by calling the Washington State Department of Transportation ADA Accommodation Hotline collect 206-389-2839.

Persons with hearing impairments may access Washington State Telecommunications Relay Service (TTY) at 1-800-833-6388, or Tele-Braille at 1-800-833-6385, or Voice at 1-800-833-6384, and ask to be connected to 360-705-7097.

Number: E 1018.00

Date: September 26, 2001

/s/ Douglas B. MacDonald
Secretary of Transportation

Environmental Policy Statement

The Department of Transportation acknowledges the state's vital interests in protecting and preserving natural resources and other environmental assets, and its citizens' health and safety. These interests must be integrated with other vital interests, including the cost-effective delivery and operation of transportation systems and services that meet public needs.

The department shall conduct all its affairs in accordance with the dictates of sound environmental protection practices, including pollution prevention wherever reasonably possible. The department shall also avoid, minimize and appropriately mitigate adverse environmental impacts. These undertakings extend to the construction, maintenance and operation of its systems and facilities. Legal obligations in these matters are established by applicable laws and regulations; this Policy Statement is not intended to create further or additional legally enforceable requirements.

To support the performance of the department's responsibilities and undertakings, as Secretary of Transportation, I hereby commit the department:

- To implement and maintain an environmental management system that embraces all the department's program functions.
- To establish, maintain and make available to the public appropriate performance indicators of the department's exercise of its environmental stewardship, and to consistently review these indicators as a basis to improve the department's performance.
- To comply with all environmental laws and regulations applicable to our business and activities.
- To assure that employees of the department receive training appropriate to their functions concerning the department's environmental responsibilities.
- To communicate to contractors, designers, consultants and other participants in the department's work the management practices and compliance requirements established to further the aims of this Policy Statement.

- To encourage employees and all other citizens to communicate with the department about ways to increase the effectiveness of department practices supporting its mission of environmental stewardship.
- To make every reasonable effort to also protect the cultural and historic resources of the state.

Each employee of the department is charged to exercise his or her responsibility on behalf of the department to assure that the intentions of the Policy Statement are diligently carried out.

Alternate Formats: Persons with disabilities may request this information be prepared and supplied in alternate formats by calling the WSDOT ADA Accommodation Hotline collect 206-389-2839. Persons with hearing impairments may access WA State Telecommunications Relay Service at TT 1-800-833-6388, Tele-Braille 1-800-833-6385, or Voice 1-800-833-6384, and ask to be connected to (360) 705-7097.

Foreword

Reliable, well-maintained highway transportation facilities are essential to the well being of the state, its citizens, and its commerce. The Washington Department of Transportation's Maintenance and Operations personnel are essential to the state's transportation backbone – the state highway system. Public safety and the safety of our employees is a high priority and must be considered in every decision and activity affecting the highway facilities. The goal of Maintenance and Operations is to retain the highway system in a condition as near as possible to the condition of its initial construction or subsequent improvement. We all take pride in and strive for excellence in the maintenance and operations of our highway system.

Ken Kirkland
State Maintenance Engineer

Brian Ziegler
Director of Maintenance &
Operations

Introduction

Purpose of this Manual

The purpose of this Maintenance Manual is to provide Maintenance personnel with guidance on how to conduct a wide variety of activities performed within the Maintenance Programs. The focus is on types of equipment, materials, techniques, and other information needed to properly carry out basic maintenance activities such as patching a pothole or removing snow from a roadway. Although this guidance does not establish absolute standards, it helps to promote uniform operating procedures and performance guidelines. Highway maintenance is carried out in a dynamic environment where varying factors can lead to different solutions to maintenance problems. Maintenance and Operations personnel need flexibility to match the appropriate solutions to different conditions. The Maintenance Manual is one of many resources that are available for trained maintenance personnel to utilize in applying their professional judgment to their daily work.

Performance Measurement

The extent to which maintenance activities are conducted is primarily determined by the level of funding provided each biennium by the Washington State Legislature. By placing their trust, in the form of a two hundred fifty million dollar appropriation per biennium, both the Legislature and the public are expecting the Departments Maintenance organizations to deliver their program in a timely and efficient manner. To better communicate the outcomes of the maintenance program, the Maintenance Accountability Program (MAP) has been developed and integrated into the Highway Maintenance Program. The MAP uses performance measures to communicate in easily understood terms the Level of Service (LOS) Maintenance delivers for various maintenance activities. A comprehensive MAP manual has been developed and is available for use by maintenance personnel. The MAP manual is available by visiting the Headquarters Maintenance organizations internet web site.

LOS is based on a letter-grade scale of “A” (highest level of funding) to “F” (lowest level of funding). The LOS for each activity is determined by conducting field condition assessments at highway locations randomly-selected throughout the state during the fall and spring of each year. The LOS targets, by MAP activity, are determined by statewide Maintenance staff utilizing both funding and Legislative guidance to provide the appropriate emphasis. The semi-annual surveys can be a valuable management tool for Maintenance Managers in allocating funds amongst various maintenance activities as well as adjusting their work schedules to achieve LOS targets.

Environmental Responsibilities

Just as we are entrusted with public monies to maintain the highway system, we are also entrusted with being good stewards of the public right-of-way associated with the highway system. As the population of Washington State continues to grow, the environmental value of the highway right-of-way and adjacent lands is also increasing. Whether the right-of-way or adjacent lands serve as habitat for burrowing owls, a conveyance for stormwater runoff into salmon-bearing streams, or as a haven for native plant species, it is reasonable to expect that the increasing environmental protection requirements will necessitate changes in how many maintenance activities are performed.

Many resources are available to assist maintenance personnel in conducting maintenance activities in compliance with environmental requirements. Several environmental guidance documents are available on the Headquarters Maintenance and Operations web site. Particularly applicable to specific maintenance activities is the WSDOT Maintenance Manual for Water Quality and Habitat Protection. This manual contains a number of best management practices that can be used for a variety of activities and/or conditions to ensure environmental compliance. Personnel are available in both the Headquarters Maintenance and Operations Office as well as Regional Environmental offices to assist in providing guidance on environmental issues. One of the most valued environmental resources that can be developed by maintenance personnel is a positive work relationship with local environmental regulators such as the Washington Department of Fish and Wildlife's Area Habitat Biologists. Such a positive work relationship will help maintenance personnel to not only deliver their program in a timely manner but to do so in conformance with environmental best practice methods.

Fiscal Management

Sound fiscal management is a key ingredient in delivering the maintenance program in an effective and efficient manner. Once the biennial budget is distributed to region maintenance organizations it is essential that the expenditure for various activities be accurately documented. This is accomplished through the Departments labor collection and voucher processing systems which not only provide an expenditure record for each maintenance activity, but also the detailed components that make up the cost, i.e., regular time, overtime, vendor services, materials, and equipment. By tracking the expenditure of activities Maintenance Managers are not only aware of the costs of doing business relative to targets but are better positioned to adjust their schedules to meet evolving problems and/or deliver their programs.

Foreword	i
Introduction	ii
Chapter 1 Emergency Procedures	
General Responsibilities	1-1
Regional Emergency Response Plans	1-2
WSDOT Disaster Plan	1-2
Concepts of Operations	1-2
Organization and Assignment of Responsibilities	1-2
Administration and Logistics	1-3
Plan Development and Maintenance	1-3
Training and Exercises	1-3
Emergency Operating Procedures	1-3
General	1-3
Maintenance Field Personnel	1-4
Maintenance Superintendent or Supervisor	1-5
Abandoned Cargo	1-5
Clearing the Highway	1-6
Open Road Policy	1-6
Chapter 2 Work Zone Traffic Control and Safety	
General	2-1
Fundamental Principles	2-1
Traffic Control Zones	2-2
Traffic Control Devices	2-3
Cone Placement Procedure	2-5
Traffic Control Procedures	2-8
Off-Road Activities	2-9
Nighttime Activities	2-9
Non-motorized Traffic Control	2-10
Pedestrian Control	2-10
Bicycle Control	2-10
Safety	2-11
Work Zone Operations	2-11
Enforcement	2-12
Resources for Traffic Control and Work Zone Safety	2-12

Chapter 3 Pavement Patching & Repair

General.....	3-1
Maintenance of Flexible Pavements	3-2
Load & Speed Restrictions	3-2
Pavement Deficiencies.....	3-2
Rutting	3-2
Alligator Cracking	3-2
Longitudinal Cracking.....	3-3
Transverse Cracking.....	3-3
Potholes	3-3
Raveling & Pitting	3-3
Flushing	3-4
Sags and Humps	3-4
Edge Raveling	3-4
Pavement Maintenance Techniques.....	3-4
Patching	3-4
Patching with Base Repair.....	3-4
Overlay Patches	3-6
Spreader Box Patching.....	3-7
Grader Patching	3-8
Rolling Hot Mix Patches.....	3-8
Effects of Traffic on a Patching Operation	3-9
Crack Sealing (or Pouring).....	3-10
Hot Pour Method	3-10
Cold Pour Method	3-10
Maintenance of Rigid Pavements.....	3-11
Portland Cement Concrete Pavement Crack Pouring.....	3-11
Asphalt Emulsion Surface Treatment.....	3-14
Fog Seals	3-14
Sand Seal	3-14
Aggregate (Chip) Seal.....	3-14
Pavement Conditions for a Successful Project	3-15
Material Selection.....	3-15
Asphalts and Emulsions	3-15
Common Types of Emulsions Used for Chip Seals	3-15
Aggregate	3-16
Weather	3-16
Roadway Preparation	3-16
Equipment	3-16

Distributor	3-16
Calibration Procedures.....	3-17
Distributor Calibrations.....	3-17
Nozzle Size	3-18
Proper Pressure	3-18
Spray Bar Height	3-20
Proper Nozzle Angle.....	3-21
Streaking Will Occur:.....	3-21
Cleaning of Distributor.....	3-21
Checking the Bitumeter.....	3-22
Traffic Control	3-22
Application of Asphalt.....	3-22
Spreading Aggregate.....	3-23
Chip spreader Calibration.....	3-23
Chip Spreader	3-24
Rolling	3-25
Spreading of Fines or Choking - Optional.....	3-25
Post-Seal Inspection.....	3-26
DOs of Seal Coating.....	3-26
DO NOTs of Seal Coating.....	3-27
Blade Mixed Asphalt Mix.....	3-27
Handling Emulsified Asphalts	3-28

Chapter 4 Drainage

General.....	4-1
Drainage from Abutting Properties.....	4-1
Ditches and Gutters.....	4-2
Rockfall Ditches and Slope Benches.....	4-3
Dry Wells	4-3
Culverts.....	4-3
Automatic Pumps.....	4-4
Under Drains.....	4-4
Storm Sewers.....	4-4
Bank Protection	4-5
Detention Ponds and Tanks.....	4-6

Chapter 5 Maintenance of Structures

General..... 5-1
Bridge Repair Guidelines 5-4
Bridge Information 5-5
Environmental Aspects 5-5
Utility Installations 5-7

Chapter 6 Roadside Management

General..... 6-1
Definitions..... 6-1
Reference 6-2
Resources 6-2
Roadside Functions..... 6-3
Roadside Treatment 6-4
Maintenance Involvement in the Roadside Management Process 6-4
Roadside Maintenance and the Maintenance Accountability Process..... 6-4
Roadside Management Zones..... 6-5
Typical Roadside Management Zones 6-7
Functional Zone Objectives..... 6-7
Maintenance of Zone 1 6-8
 Policy 6-8
 Methods 6-8
Maintenance of Zone 2 6-9
 Policy 6-9
 Methods 6-9
Maintenance of Zone 3 6-10
 Policy 6-10
 Methods 6-10
Integrated Vegetation Management 6-10
Methods 6-11
Noxious Weed Control..... 6-12
 First Priority 6-12
 Second Priority 6-12
 Lowest Priority 6-13
Danger Trees..... 6-13
Disposal of Logs Dumped on Right of Way 6-13
Removal of Dangerous Objects and Structures 6-14
Trespass and Encroachment..... 6-14
Encroachments- General..... 6-14
Encroachment- Maintenance Crew Responsibilities 6-14

Franchises and Permits	6-15
The Use of Pesticides.....	6-16
Pesticide License	6-16
Record Keeping	6-16
Product Labels	6-16
Posting Requirements	6-17
Aquatic Pesticide Applications	6-17
Pesticide Sensitive Individuals	6-17
Container Disposal	6-17
Use of Mowing Equipment.....	6-18
Other Cutting Methods	6-19
Cultural Control Methods.....	6-19
Biological Control	6-19
Burning Debris.....	6-20
Illegal Tree Removal.....	6-20
Significant Roadside Activities.....	6-20
Definitions.....	6-21
Notification	6-21
Removal of Debris and Rubbish.....	6-22
Litter Control and Partnerships for Roadside Enhancement	6-22
Adopt-a-Highway	6-23
Program Rules	6-23
Participant Eligibility.....	6-23
Assignment of Sections	6-24
Volunteer Adoptions	6-24
Sponsored Adoptions	6-25
General Permits for Roadside Enhancement	6-26
AAH Administrative Roles and Responsibilities	6-26
Maintenance & Operations Responsibilities	6-26
Region Responsibilities	6-27
Auxiliary Facilities	6-27
Safety Rest Areas	6-27
Park and Ride Lots	6-28
Historical Markers	6-28
Viewpoints	6-29

Chapter 7 Snow and Ice Control

General..... 7-1

Preparation for Winter Operations..... 7-1

Highway Categories..... 7-3

Special Criteria 7-4

Work on State Highways 7-4

City Streets on the State Highway System 7-6

Work on Other Roads and Areas..... 7-6

Abandoned or Illegally Parked Vehicles..... 7-7

Closures 7-7

Emergency Assistance 7-8

Precautions..... 7-9

Service Level Quality Measurement 7-9

Chapter 8 Traffic Services

General..... 8-1

Reconstruction Principles 8-1

Signing 8-2

Signing Responsibility..... 8-2

Sign Installation 8-2

Maintenance..... 8-3

Sign Visibility 8-4

Sign Storage and Transportation..... 8-4

Delineation..... 8-5

Pavement Markings 8-5

Materials 8-6

Application 8-6

Marking Renewal or Replacement Frequency 8-7

Removal of Markings 8-7

Guideposts 8-8

Traffic Barriers and Impact Attenuators 8-8

Maintenance..... 8-8

Inspection..... 8-8

Repair..... 8-8

 Standard Run of Barrier 8-9

Transitions 8-10

Impact Attenuators..... 8-10

Maintenance..... 8-10

Islands..... 8-11

Transit Vehicle Stop Zones 8-11

 Maintenance 8-11

Chapter 9 Electrical System Maintenance

General..... 9-1

Wiring and Connection Maintenance 9-1

Enclosure Maintenance..... 9-1

Documentation..... 9-1

Changeable Message Sign Systems..... 9-1

Drain Pump Systems..... 9-2

Gate and Barrier Systems 9-2

 Minor 9-2

 Major 9-2

Intersection Control Beacons(Includes Hazard Beacons) 9-2

Illumination Systems 9-2

 Roadway Illumination Systems..... 9-2

Sign Lighting Systems 9-3

Services..... 9-3

Signal Systems..... 9-3

Vehicle Detection Systems 9-3

Pedestrian Detection and Display System 9-3

Vehicle Display Systems..... 9-3

Signal Control Systems..... 9-4

Sprinkler Systems 9-4

Television Systems 9-4

Chapter 10 Miscellaneous

Right of Way Fences..... 10-1

Road Approaches- General 10-1

Typical Maintenance Responsibilities in Cities..... 10-1

Maintenance Yards..... 10-6

Stockpile Sites 10-6

Materials from State Quarries or Pits 10-7

Procurement of Materials 10-7

Material Specifications-General 10-7

Disposal of Surplus Items 10-8

 Equipment 10-8

 Inventoried Items 10-8

 Non-Inventoried Items 10-8

Instructions for Radio Operation 10-8

General Technique 10-8

Helpful Reminders..... 10-8

Work Scheduling and Reporting..... 10-9

Contents

Budget..... 10-9
Scheduling 10-9
Reporting 10-10
Environmental Sensitivity 10-10

Acronyms and Abbreviations

Appendices

City Streets as Part of State Highways

City Streets as Part of State Highways 1-2
Agreed Upon Guidelines 1-2
Concurrences 1-9
Concurrences with Recommendations for Acceptance 1-9
Recommendations Accepted..... 1-9

Figures

Emergency Procedures Manual

Work Zone Traffic Control Guidelines

Highway Engineering Field Formulas

Index

General Responsibilities

This chapter provides guidance to reduce the vulnerability of the state transportation system from any emergency or disaster by:

1. Establishing capabilities for protecting the transportation system and employees from the effects of emergencies or disasters,
2. Responding efficiently to emergencies and disasters,
3. Assist in recovering in the aftermath of any emergency or disaster.

This chapter also incorporates some of the day-to-day operational procedures that are used in responding to incidents such as small spills, snow/ice removal, traffic accidents, emergencies, disaster events, and recovery efforts. The Washington State Department of Transportation (WSDOT) Disaster Plan and the Emergency Procedures Manual (M30-14) define the details of how the Department responds to these types of events and is included as an Appendix for reference purposes.

An emergency is defined as a situation involving natural phenomena, disasters, casualties, national defense or security measures, etc. and includes response activities that must be taken to prevent the imminent loss of human life or property.

WSDOT will perform the following functions in emergency situations:

- Determine usable portions of the state highway network. Coordinate and control emergency highway traffic regulations in conjunction with the Washington State Patrol.
- Notify your local Washington Department of Fish and Wildlife (WDFW) local habitat biologist that an emergency action needs to be taken and obtain the Hydraulic Project Approval (HPA) as soon as possible after taking the emergency action.
- Notify the “National Marine Fisheries Service and U.S. Fish and Wildlife Service” that maintenance is taking an emergency action that could result in an “after the fact” consultation under the endangered species act, if the emergency action involves threatened or endangered species’ water bodies.
- Follow the memorandum of understanding on “Emergency Actions in Water Courses” with the Washington Department of Fish and Wildlife.
- Meet the conditions of the Washington Department of Fish and Wildlife (HPA) permit if applicable and possible.
- Reconstruct, repair and maintain state highways, bridges, and alternate routes. Coordinate the mobilization of personnel and equipment required for emergency engineering services.
- Maintain liaison with the Washington State Chapter of the Associated General Contractors of Washington and America, construction, and equipment rental companies.

- Provide initial damage assessment estimates on state and local facilities (both for federal aid eligible roads and non-federal aid eligible roads) and public/private airports as a member of the Preliminary Damage Assessment (PDA) Team.
- Participate on Damage Survey/Inspection Report Teams, conducting inspections of federal aid and non-federal aid system highway facilities damaged by a disaster.
- Coordinate all transportation related missions including, emergency air, marine and rail transportation of personnel and essential supplies.
- Conduct aerial reconnaissance and photographic missions.
- Provide public information support to the Office of the Governor and the Washington Emergency Operations Center during emergency response and recovery operations.

Regional Emergency Response Plans

Each Region shall develop and maintain an Emergency Response Plan that will establish day-to-day operational procedures to cope with routine spills, accidents, etc. Regions will also develop procedures to address their response capabilities for those events that are beyond the normal day-to-day operational mode. Each of these procedures shall clearly define employee roles and responsibilities.

WSDOT Disaster Plan

Concepts of Operations

Governments have the responsibility to make every effort to protect life and property during emergencies. When the emergency exceeds the capability of government to respond, assistance will be requested from the next higher level of government.

For example:

Local government may request state assistance and state government may request federal assistance. However, this plan heavily emphasizes the responsibility and capability of local governments to respond to and accomplish short-term recovery during emergencies/disasters.

The WSDOT Disaster Plan recognizes that emergency functions for groups and individuals should parallel normal day-to-day functions. When this is not possible, managers should attempt to maintain organizational continuity and assign familiar tasks to employees.

Organization and Assignment of Responsibilities

Service Centers and Regional Offices have emergency functions in addition to normal duties. Each Service Center and Regional Office establishes procedures for:

- Operations during emergencies.
- Emergency Personnel Roster.
- Compliance with WSDOT Responsibilities and Authorities.

Administration and Logistics

WSDOT acknowledges that in a time of crisis, some administrative procedures should be suspended, relaxed or made optional. However, it is desirable to foresee and plan for necessary changes in administrative procedures.

Documentation is critical for successful reimbursement of funds or to support liability issues. All actions taken, especially changes to established procedures, shall be documented. This is the responsibility of Maintenance Lead Technicians, Maintenance Supervisors and Superintendents. It is proper in these situations to use all tools that are available in order to provide a clear documentation trail. Maintenance office staff are to be provided the documentation and then are tasked with filling out the proper records and forms to be forwarded to the Regional Maintenance administration.

Plan Development and Maintenance

The WSDOT Disaster Plan is the principal source of documented department emergency management activities. Most Service Centers and Regional Offices are responsible for developing or accomplishing tasks in some part of the plan. This may require simultaneous coordination with local, state and federal agencies. Overall, the Headquarters WSDOT Disaster Plan development, maintenance and coordination is the WSDOT Emergency Management Program Manager's responsibility in cooperation with Service Centers and Regional Offices.

Training and Exercises

WSDOT will periodically provide training and conduct exercises to test the WSDOT Disaster Plan and Procedures to assure maintenance of a readiness mode and reflection of current department operational practices.

Emergency Operating Procedures

General

There are many situations when transportation crews may be exposed to situations requiring emergency action. The most common emergency situations maintenance crews may encounter are vehicle accidents and hazardous material spills.

Hazardous materials are those substances which, when spilled, may make driving on the roadway unsafe, endanger the lives of people in the vicinity, or contaminate the environment. These materials may make the roadway surface slippery, impair visibility, or cause lane and road closures. Materials that may be dangerous in themselves include: explosives, flammables, corrosives, poisons, and radioactive materials. Other materials may not be hazardous but cause hazardous conditions such as fine powder- like materials which create visibility problems or bulky materials which cause lane closure.

WSDOT employees at the scene of an accident or spill will take emergency actions only as required to protect human life and property until the Washington State Patrol has control of the situation. The State Patrol has the responsibility for safety measures at an accident site and for coordination with Department of Ecology for the clean-up of spilled substances. The Washington State Patrol may request assistance from WSDOT for traffic control and to clean up an

ccident site. WSDOT employees must not attempt to clean up any hazardous material spills. In most cases WSDOT Maintenance employee's have not been trained and/or do not have the proper resources to clean up hazardous spills. Clean up is the responsibility of the owner or shipper of the cargo, if they can be identified. If the owner/generator is unknown, the Department of Ecology is responsible for the clean up. In general terms Ecology personnel only respond onsite to spills greater than 50 gallons of hazardous material.

Maintenance Field Personnel

Maintenance employees will take the following actions when encountering a hazardous condition:

- Advise the Area Maintenance Supervisor or Superintendent of the problem, and request aid from the Washington State Patrol.
- Take precautionary actions to protect themselves, maintenance crews, and the traveling public from any exposure.
- Provide traffic control, including closure of the highway if appropriate, to ensure that no one comes in contact with the hazardous material.
- Survey the situation and report the exact location, cause of the temporary closure, and extent of the closure to the Area or Regional Maintenance Office (or your Maintenance Supervisor or Lead Technician). Notification should also go to the TMC, Traffic Management Center, in each Region if they have one in place.
- If the spilled substance is identified and is spreading toward water courses, additional traffic lanes, or likely to cause ground water damage, take appropriate action to absorb or confine the spill. Always use careful judgment and only take actions you know and understand are safe for you to do. Examples of commonly spilled materials include gas, oil and diesel.
- Never take action on an unknown substance or on a known substance that is extremely dangerous to life and property. Examples would include those products with greater harm than gas, oil and diesel. If employee's are not sure what the product is they are to stay clear of the area.
- Some accident scenes include human tissue and blood residues. Contact with these materials is to be avoided. Fire response should wash this residue from the highway or highway feature surfaces. The Washington State Patrol is the incident commander and should assure that the accident scene is ultimately safe.
- Stay on site to safeguard traffic until proper traffic control devices are installed and/or until relieved by your Maintenance Supervisor, Lead Technician, or a Washington State Patrol Trooper.
- Patrol for stranded motorists in isolated areas when traffic has been controlled and when applicable.

Maintenance Superintendent or Supervisor

- Coordinate personnel and equipment to close a highway or restrain traffic from entering a hazardous area.
- Make a complete report of the closure to the Regional Maintenance Engineer/ Manager and Traffic Control Center (TMC).
- Ensure the hazardous section of highway is being monitored, then patrol the area to make sure there are not stranded motorists.
- Provide detours around partial closures when safe to do so. When ever possible, establish detours on existing state routes. Other local roads should only be used after surfaces, bridges, and overhead clearance restrictions have been reviewed and approved by the appropriate local jurisdiction. Detours will be signed and other traffic control devices (e.g., barricades and flashing lights) will be installed. Station flaggers at barricaded points when necessary.
- Arrange to advise the Regional Public Information Office so that announcements of the closure can be made on the WSDOT public service and communications networks.
- If a closure is requested by the Washington State Patrol, and the local Maintenance Superintendent is not available, contact the Regional Maintenance Manager or the Regional Administrator to advise of the request and provide recommendations concerning the need for the proposed temporary closure.
- Reopen the roadway when the physical blockage is eliminated or the hazardous conditions that caused the closure have abated.
- Advise the Area Maintenance Superintendent, Regional Maintenance Manager, or Regional Administrator of the reopening by the fastest means available.
- Arrange to relay notice of the reopening to the Regional Public Information Office to ensure that information on the public service and communications network is current.

Abandoned Cargo

- All cargo spilled on WSDOT property will be removed at the owner's expense if the owner can be identified. A determination that the cargo is hazardous material will necessitate the procedures outlined earlier. State law (RCW 4.24.512) dictates that the responsible party has the responsibility for clean up of hazardous materials.
- If the spilled material is hazardous, stay safely back from the hazard, establish traffic control, and call the Washington State Patrol who in turn will call the Department of Ecology Spill Response Team. The Department of Ecology is responsible for coordinating clean-up of hazardous materials. If dropped material is identified as hazardous but the container is not leaking or severely damaged, it can be removed to the edge of the shoulder to allow traffic flow if this action must be taken prior to Ecology's arrival at the scene. It should not be taken back to the maintenance facility.

- If dropped material is identified as non-hazardous and is reusable it should be returned to the maintenance facility. After a determination of ownership is made and if the commodity is not reclaimed within (30) days it becomes the property of the department and may be used for its intended purpose, if appropriate.

Clearing the Highway

Open Road Policy

- The February 2002 WSP/WSDOT “Joint Operating Policy Statement” was developed to stress the importance of the Agencies’ responsibility to do whatever is reasonable to reduce the delays associated with incidents and collisions. The open roads philosophy of this policy statement is that WSP and WSDOT shall open the roadway as soon as possible on an urgent basis.
- It is a goal of WSDOT to minimize traffic delays caused by vehicle accidents and incidents. WSDOT Maintenance personnel assisting at vehicle accidents will make every reasonable effort to clear the traveled way as quickly as possible.
- First priority -safety: It is the departments’ obligation and responsibility to provide a safe environment for its employees and the public.
- Second priority- Minimizing traffic delay: Maintenance personnel responding to vehicle accidents which involve lane closures will consider every reasonable measure in coordination with WSP, to clear the lane as quickly as possible. At accident scenes which involve spilled or damaged cargo, the overriding strategy will be to minimize traffic delay. Salvage of the cargo will be secondary and at the convenience and benefit of transportation movement.
Criteria to be used in making “Open Road” decisions include:
 - crime scene investigation
 - traffic volume
 - time of day
- Lowest priority- The potential salvage of the cargo should be the last consideration in decisions related to minimizing traffic delay.
- Bridges and other transportation structures closed due to structural damage require approval from the Bridge Preservation Engineer before opening.

General

Safe and effective traffic control is vital for the safety of the traveling public. It is also essential to protect construction, maintenance and utility workers whose work places them near high speed traffic. The traffic control guidelines in this manual provide the driving public positive and consistent guidance through work zones. These procedures will also reduce the risk to maintenance workers who are exposed to potential traffic hazards

The Secretary of Transportation has adopted the Manual on Uniform Traffic Control Devices (MUTCD) as the legal standard as required by RCW 47.36.030. **It is mandatory that traffic control measures on maintenance projects comply with the MUTCD requirements.** The MUTCD outlines basic principles and prescribes standards for the design, application, installation, and maintenance of traffic control devices. The MUTCD details requirements for color, size, shape, location and need for traffic control devices.

In some cases WSDOT has standards that exceed those in the MUTCD (e.g., see Traffic Manual, M 51-02, Chapter 5 and the Work Zone Traffic Control Guidelines Book, M 54-44) which is included as an appendix. In such situations the most stringent standard is the legal standard you must follow. Learn those standards before you perform traffic control.

Consult the Regional Traffic Engineer when standard layouts are not applicable.

This chapter reflects the work and recommendations provided by the Work Zone Safety Task Force. The Work Zone Traffic Control Guidelines Book (M 54-44) incorporates the recommendations of the Work Zone Safety Task Force and the standards of the MUTCD, and is intended to be used as the companion resource to the guidance in this chapter.

The maintenance employee in charge at a work zone is responsible to see all standards are followed. This includes ensuring temporary signs, warning devices, and flag persons are placed appropriately to protect both motorists and workers. **Motorist and worker safety are of primary importance. Safety takes precedence over all efforts to maintain a highway or structure.**

Fundamental Principles

Principles to enhance motorist and worker safety in maintenance work areas:

- Develop a comprehensive traffic control strategy that can be implemented at the work site. Evaluation of the work operation, site, and traffic conditions should determine the traffic control measures to be utilized. Refer to the Work Zone Traffic Control Guidelines Book, “checklist for establishing a temporary traffic control zone” and the Traffic Manual, “traffic control planning and strategy checklist”.

- Maintain traffic flow as close to normal highway situations as possible.
- Do not surprise the motorist. Locate and place devices to maintain adequate sight distance for driver recognition and reaction on straight highway sections if possible.
- Prepare, understand, and implement a traffic control plan. Don't routinely rely on minimum standards. Evaluation of the work operation, site and traffic conditions should be determined to the appropriate level of traffic control measures.
- Avoid frequent and abrupt changes in alignment.
- Minimize worker exposure time to traffic.
- Provide adequate warning, delineation, and channelization.
- Remove inappropriate pavement markings on long-term projects.
- Provide flagging only when other methods of traffic control are inadequate.
- Inspect traffic set-up control measures prior to work.
- Monitor traffic control and modify where changing traffic conditions warrant.
- Remove, cover, or turn control devices away from traffic when not needed or in use.
- Channelize traffic with pavement markings, signing, cones, plastic barrels, water filled barriers, or lightweight devices.
- Sand bags may be used for sign ballast. Do not use heavy, solid weights, (e.g., concrete blocks) for stabilizing portable sign supports.
- Traffic control measures must be selected and implemented with the drivers' perspective in mind. Credible messages must be sent to the driver to provide a reasonable expectation that the driver will comply.
- Plan ahead for work operations and the associated traffic control. Don't rely completely on standard devices and procedures when more effective measures should be considered.
- Use traffic control devices (cones and barrels) to define the closed portion of the roadway that is the work zone. Even short term operations can realize a safety benefit from placing cones in a manner that sends an obvious message to drivers that a portion of the road is closed and they must divert around the work zone.

Traffic Control Zones

The traffic control zone is the work area between the first advance warning sign and the point beyond where traffic is no longer affected (see Figure 2-1). Traffic control zones are divided into the following areas:

- Advance warning area
 - Transition area (for lane or shoulder closures)
 - Buffer space
 - Work area
 - Termination area
1. **Advance warning area** - The Advance Warning Signs are located before the transition area to provide ample opportunity for motorists to accomplish a desired maneuver. Where there is no lane or shoulder closure, as in mowing

operations, one sign will suffice. Use signs on both sides of two-way, two lane highways and multilane roadways.

Message - Information - Action (MIA) - signing must relate to all three action words.

The first sign to appear in the advance warning area tells motorists they are approaching a work zone (e.g., ROAD WORK AHEAD). The next sign display provides more detailed information about the situation ahead (e.g., ONE LANE ROAD AHEAD), and the third sign states what action to take (e.g., BE PREPARED TO STOP).

2. **Transition area** - This is the zone where the lane and/or shoulder is closed by cones or channelizing devices. The rate of taper is in accordance with the traffic control plans in the Standard Plans. If restricted sight distance is a problem (e.g., sharp vertical or horizontal curve), begin the lane closure well in advance of the view obstruction. Do not hide the beginning of lane closures behind curves.
3. **Buffer space** - This is the unoccupied space between the transition and work areas. It is there to provide a margin of safety for both traffic and workers. With moving operations, buffer space is the space between the attenuator/buffer truck and the work vehicle.
4. **Work area** - Where equipment and workers perform maintenance functions.
5. **Termination area** - Allows traffic to resume normal driving immediately after leaving the work area.

Traffic Control Devices

Traffic control devices are used to warn, regulate, and guide traffic. They include: signs, signals, lighting devices, pavement markings, delineators, channeling devices, hand signaling devices, and temporary barriers. **Traffic control devices must conform to WSDOT and MUTCD standards.** Use traffic control devices where necessary. Remove, cover, or turn them away from traffic when they are not in use or no longer applicable.

1. **Signs and Supports** - Sign supports are either portable or fixed depending on the duration of work. Small sand bags may be used to stabilize portable sign supports. Do not use objects that could become a projectile upon impact (e.g., concrete, chain, etc.). Sign supports should be lightweight, yielding or breakaway in composition.

Signs on portable supports must be (1) foot above the roadway. Those mounted on fixed posts must be (5) feet above the roadway in rural areas and (7) feet above the roadway in urban areas.

Sign spacing is set forth in Appendix A. Follow these sign spacing requirements but also consider in-place existing signs when developing traffic control plans.

Regulatory signs - (e.g., KEEP RIGHT, DO NOT PASS) These signs impose legal restrictions, and are placed where the regulation applies. Most regulatory signs are black on white. **(Use them only as necessary)**

Reduced legal speed limits - Only use reduced legal speed limits when other efforts to control traffic prove to be inadequate. For emergency and other speed reductions, follow speed reduction guidelines outlined in RCW 47.48.020, the WSDOT Construction Manual (M 41-01), and WSDOT Directive D 55-20, Reduced Speed in Maintenance and Construction Work Zones.

To change a speed limit, submit a request to do so to the Regional Traffic Engineer. To ensure a work zone is adequately signed, post the speed limit signs in the work zone. Post regulatory speed limit signs for work hours only (identify hours when the limit is in effect). Remove all signs when the reduced speed limit is not in effect.

Warning signs - Their purpose is to give motorists notice of potentially hazardous conditions for traffic. They are erected in advance of the condition. Use warning signs when conditions warrant, particularly if the hazard is not obvious or cannot be seen by approaching motorists. Don't overuse warning signs or they will lose their attention-getting value.

All warning signs shall have black legends on an orange background (except the round railroad advance sign, which is black on yellow). **Do not use double faced (back-to-back) signs.**

Changeable message signs - These signs are recommended for high speed, high volume roadways, or work operations that require a highly visible message. Use them to supplement or enhance work zone safety and not to replace required signs. Two message panels are the maximum allowed. Consider truck mounted Portable Changeable Message Signs (PCMS) for shadow/ buffer vehicles.

Some typical situations include:

- Locations where speed of traffic is expected to drop substantially
- Locations where significant delays are expected
- Accident or incident management

Make messages clear and brief, keeping messages to a maximum of two panels. If special messages are necessary, be consistent with conventional signs and standards normally used. Whenever possible use the pre-programmed stored messages the PCMS is equipped with. Never display a message with an arrow from a PCMS that is located on the same shoulder as the arrow direction (right shoulder/right arrow or left shoulder/left arrow).

2. **Channelizing Devices** - Channelization devices are used to direct traffic away from or around a work area, or to separate two-way traffic. Tubular markers, cones And plastic barrels/drums are effective. Channelization devices must be reflective for night use.

Cones - These are the most common device used to separate and guide traffic past a work zone. Cones must be at least 18 inches tall for normal situations. But, they must be 28 inches tall minimum, for high speed, or high volume operations.

Reduced device spacing around work zones is recommended. Make provisions for large work vehicle access as needed (routed off the existing shoulder or through a stagger of channelization devices).

Place barrels or cones diagonally across closed lanes to show motorists which lanes are closed.

Refer to the Work Zone Traffic Control Guidelines Book for more information on channelization devices, application and placement.

Cone Placement Procedure

Prior to establishing traffic control with cones, a meeting is held by the involved parties to discuss the following procedures:

- Technique (e.g., a whistle or voice actuated headset) for signaling between the cone handler and truck operator.
- Will cone tapers across the closed lanes be done by hand?
- Set up and take down a line of cones along lane or center lines:
- The cone handler should ride in a cone setting cage attached to the front, back or side of the traffic control vehicle, to set and remove cones in the work zone.
- The driver is responsible for: safe operation of the vehicle, maintaining the vehicle at a safe speed, watching the cone side and the front of the vehicle, and watching the cone handler.
- The cone handler is responsible for setting and removing cones, and signaling the driver in case of any obstruction or emergency.
- The driver and cone handler will decide if a shadow vehicle with a truck mounted attenuator is required to protect the cone handler while exposed to traffic.

Traffic Safety- Drums are used on freeways due to greater target value and imposing size.

Barricades- They protect spot hazards and close roadways and sidewalks with appropriate signing.

Barricades can also be used to provide additional protection to work areas. **Lights used to channelize traffic** must be steady burning, “Type C”. Do not use flashing, “Type A”, warning **lights on barricades to channelize traffic**.

Temporary pavement markings - These markings delineate lanes and tapers on long-term projects. Remove existing markings that may confuse motorists. For short-term maintenance operations, it is not practical to remove and then restore pavement markings. If it is necessary to divert traffic across existing pavement markings, the channelizing device used must be so dominant that a motorist’s

attention is drawn completely away from the existing marking. Reduced device spacing is recommended. The use of removable black mask tape (see QPL) Qualified Products List may also be considered to temporarily cover existing markings.

High level warning devices - They are tall, portable stands with flags or flashing lights visible above traffic. Used with flags only, they may have a sign or flashing light attached, or be attached to vehicles used in moving or mobile work operations. (See MUTCD, Part VI).

3. **Water and Concrete Barriers** - There are three types of barrier protection used in work zones: concrete barrier, movable concrete barrier, and water-filled barrier. While barriers are effective, they may result in more damage to an impacting vehicle.

Water filled barriers- They are a portable traffic barrier designed to prevent intrusion of errant vehicles into work areas. Recommended for stationary work areas with high exposure to high speed traffic where it may not be practical to use concrete barrier, but more protection than channelization devices is desired. Up to 23 feet of lateral deflection can occur if the barrier is impacted at high speed.

Consider the use of water barriers for:

- Short term projects (zero to three days) of a minimum 100' in length.
- **Do not use in lane transitions** until further testing or the situation meets with manufacturer's specifications.
- Evaluate risk and site conditions. If used, follow manufacturer's guidelines and specifications. Consult with the Region Traffic Office prior to use.

(Additional information on concrete and water barriers is located in Chapter 5 of the Traffic Manual, M 51-02 and the Work Zone Traffic Control Guidelines Book).

Concrete barriers - They are a rigid barrier designed to prevent intrusion of errant vehicles into work areas considered the most substantial type of barrier to enhance worker safety. Contact the Region Traffic Engineer for site specific placement information.

Consider the use of concrete barriers for:

- High speed roadways and areas with a high potential for worker injuries.
- Work zones in "no escape" areas (e.g., tunnels, bridges, and lane expansion work).
- Long term, stationary jobs (work occupying a location for more than 3 days).
- Worker and traveling public exposure considerations (e.g., high speed and volume of traffic), when workers are not protected by a vehicle, and in proximity to traffic (e.g., concrete slab repair on freeways).

Movable barriers - Consider the use of movable barrier such as Transfer/Transport Vehicle (TVV) barrier and special vehicle) for:

- High volume traffic conditions with very short-term lane closures.
- Continuous operation over an extended period of time, where there is a need to get the lane back in operation at some point in the day. (Could be used in lieu of reduced lane widths or lane reduction, e.g., lane additions, wall next to roadway).

Protect the ends of concrete barriers with crash cushions or berms, unless flared outside the clear Zone. Consult with the Region Traffic Engineer to determine the appropriate end treatment. Do not use concrete barriers as a taper, but when/if flared or tapered, channelization must be used in advance (e.g., tubular markers, cones, or plastic barrels) to provide a recovery area for errant vehicles).

4. **Hand Signaling Devices** -If other methods of traffic control are inadequate to warn and direct drivers and flagger traffic control is implemented, stop / slow paddles must be at least 18 inches in diameter and reflective for night use. For high speed, high volume traffic or those locations where more advance driver attention is desired, consider the use of 24" stop/ slow paddles or the Flashing Stop/ Slow Paddle (FSSP).
5. **Lighting Devices** - Use to call attention to hazardous situations, especially at night. Includes warning lights, flashing vehicle lights, floodlights, and flashing arrow boards.

Warning lights - These lights are either flashing or steady burn (Types A, B, or C or strobe) mounted on channelizing devices, barriers and signs. Secure warning lights to the channelizing device or sign so they will not come loose and become a dangerous flying object if impacted by a vehicle. See the MUTCD, Part VI for additional information.

Flashing vehicle lights - These lights alert motorists to the potential hazards of maintenance vehicles and workers near the traveled lanes. Use flashing lights to warn of isolated hazards or signs. Snow-removal and other highway maintenance equipment use flashing lights for purposes of identification when working. Use flashing lights anytime over width equipment is on the highway per WAC 468-38-390.

Floodlights - Use them to illuminate nighttime work. Floodlights permit the crew to see what they are doing and make the crew visible to motorists. Where planned, night operations require flaggers; flood lighting must be provided to illuminate the flagger. Shield the light source to protect motorists from glare.

Steady burning lights (Type C) - Lights used in a series of channelizing devices or barriers form a taper or separate the work area from traveled lanes. Never use any type of flashing light in sequence for transitions or continuous channelization.

Flashing arrow boards and changeable message signs - They are effective for day and nighttime tapered lane closures and moving operations. At night, flashing arrow boards are required to use a photocell which automatically dims (minimum 50% dimming) so that motorists will not be temporarily blinded. When used for lane closures tapers, they are located in the lane (or partially on the shoulder) being closed, behind the taper of channelizing devices, usually within the first one third of the taper.

Do not use arrow boards or arrow displays on changeable message signs when:

- Work does not require lane closures, except for moving operations on multilane facilities.
- All work is on or outside the shoulder with no interference requiring closure of the adjacent traveled lane.
- The work is on a two-lane, two-way roadway.
- A shoulder closure is required.

Do not use more than one arrow display per lane being closed. An arrow display with a shadow vehicle (early warning) is allowed on mobile or moving lane closure operations. The caution mode (flashing four corner lights) may be used as supplemental warning at work area not requiring a lane closure.

Arrow displays used on PCMS's must meet the same performance standards for flashing arrow boards, see MUTCD, Part VI.

Traffic Control Procedures

Controlling traffic for maintenance operations is dependent upon the activity being performed, the estimated duration of the activity, type of highway, traffic speeds and traffic volume. Safety clothing will be worn by WSDOT employees while in the highway work zone (for more information, see IL 72-96, *Safety Clothing to be Worn by WSDOT Employees while in Highway Work Zones*).

Providing advance warning to drivers approaching road work is required. The specific requirements for advance warning depend on the actual site conditions and could be the flashing beacon on a work vehicle or a series of portable signs and a PCMS. (Refer to the Work Zone Traffic Control Guidelines Book and the MUTCD, Part VI for specific advance warning requirements).

Use an advance warning sign when:

- Any work activity that may distract the driver or require the driver to react, beyond the normal driving requirements for that section of road.
- Work is performed on or immediately adjacent to the roadway (within 15' of the edge of the roadway).
- Equipment may be moved along or across the highway.
- The shoulder is occupied or closed.
- There is encroachment into traveled lanes.

Typical traffic control plans and additional guidance for maintenance activities are contained in the MUTCD, Part VI and the Work Zone Traffic Control Guidelines Book. These plans establish typical signing procedures. The maintenance employee in charge must determine the extent of traffic control required to provide motorist and worker safety.

After establishing traffic control, the maintenance employee in charge will drive through the work area at expected motorist speeds to determine the plan's effectiveness. Periodic monitoring is required to ensure traffic control devices remain in place.

Changing conditions such as traffic, work, or time of day require traffic control adjustment. If an accident or near accident occurs after the control has been set up, make necessary adjustments immediately and monitor for a reasonable period. Remove, cover or turn traffic control devices during non-working hours.

Refer to the Work Zone Traffic Control Guidelines Book and the MUTCD, Part VI for guidance on specific work operations, duration of work requirements and flagging operations.

Off-Road Activities

Where work is being conducted off the roadway and shoulders, but within the right of way, the hazards are usually minimal. However, minimize risks by using an appropriate warning sign (e.g., MOWER). (See above section on advance warning signs).

Nighttime Activities

Nighttime maintenance activities are commonly performed because of lower traffic volumes and reduced traffic disruption. Nighttime work is also necessary to respond to emergencies such as fallen trees, mud slides, etc.

Night operations present additional safety concerns. All signs used at night shall be reflective or illuminated as specified in the MUTCD - Section 6F-5. Street or highway lighting does not meet the requirements for traffic control device illumination.

Floodlights may be necessary to provide work area illumination and to permit the crew and flaggers to be visible to the motorist. The light source must be shielded to protect drivers from glare. Consult the Safety and Traffic Offices to review WSDOT illumination practices.

The effectiveness of flagging is diminished at night as the flagger may not be visible to the motorist. Make efforts to control traffic by other means when possible. When used, the flagger is located within a coned area (usually the shoulder or other relatively safe location) but not within the taper itself. As with other workers in night work zones, flaggers shall wear traffic vests made of highly

visible materials supplemented with reflective material visible on all sides of the wearer and a highly visible hard hat with reflective qualities.

Portable traffic signals require approval in the traffic control plan developed by the Region Traffic Office. Portable traffic signals and lights with on-board generators are effective for controlling traffic at intersections or at each end of the work area. These units can be remote controlled by a worker, thus eliminating the need for a flagger.

Non-motorized Traffic Control

Give consideration to pedestrian and bicycle traffic where appropriate. Provide alternative routes where designated walkways or bicycle routes are temporarily interrupted due to maintenance operations. Alternative routes need to be free of obstructions and hazards (e.g., holes, debris, mud, construction and stored materials, etc.). Clearly delineate all hazards near or adjacent to the path (e.g., ditches, trenches, excavations, etc.). Bicyclists are subject to the same flagging procedures as vehicles. Do not place signs and other traffic control devices to pose a hazard.

Pedestrian Control

Alternative pedestrian walkways are provided when pedestrian activity is apparent where:

- Walkways traverse the work zone.
- A designated school route traverses the work zone.
- Significant evidence of pedestrian activity exists (e.g., a worn path).
- Existing land use generates pedestrian activity.

Consider the following principles for designing/constructing alternative pedestrian facilities:

- Separate pedestrians and vehicles by barrier or channelizing devices. Use barriers on high speed facilities. Use channelizing devices on low speed (35 mph or less) facilities.
- Walkways used at night, (especially if adjacent walkways are lighted) need temporary lighting.
- Use warning lights to delineate pathways and mark hazards.
- Pedestrians will not go out of their way. Make alternate pathways reasonable.

Bicycle Control

Bicycles have a legal right of access to most highway facilities and provisions for their safe conduct through work zones are necessary.

Provide and sign an appropriate alternate route when maintenance activities close a designated (signed) bicycle path or shoulder bikeway. Where horizontal separation for bicycles and pedestrians existed prior to work, give consideration to separating during work.

When laying out alternative bicycle paths, make sure no overhead obstructions present a direct hazard to normal bicycle operation.

Safety

The safety and welfare of WSDOT employees is paramount. Injuries are costly in terms of both human suffering and economics. For these reasons, WSDOT initiated the employee safety program over 50 years ago.

Guidelines for maintenance employee safety are contained in the Department's safety manual. Any questions about safety concerns can and should be raised to the employee's supervisor or the regional safety officer. Accidents involving equipment, falls, and other trauma injuries are a major part of worker safety. As the materials and chemicals used in maintenance become more complex, then the risks to employees also increase. Employees must be trained to know the rules, policies and practices intended to promote a safe work environment.

Safety pays dividends on all jobs. A positive attitude toward safety will not only help to protect the employee from injury, but will also lead to continued job satisfaction. Every employee needs to develop the habit of thinking safety before and during the work to be done.

Work Zone Operations

Maintenance operations require employees to be on the alert to protect themselves, fellow crew members and the traveling public. Performing jobs safely is a priority and an integral part of maintenance operations.

The fundamental guide for all staff in the control of maintenance work zones is Part VI of the "Manual on Uniform Traffic Control Devices" (MUTCD).

Work zone safety has two aspects that are sometimes not kept in balance. One is when there is too much pressure for production efficiency. The other is when there is too much fear of liability resulting from a traffic accident. Each maintenance employee, as well as each motorist, is entitled to have a work or traffic environment which is reasonably safe. Every effort must be made to ensure that the most effective traffic control strategy is implemented. This strategy must address the needs and requirements of both the workers and drivers. The development and implementation of a comprehensive traffic control strategy will satisfy the concerns of production and potential liability while providing an effective and safe work zone.

Maintenance employees may have innovative ideas that will create improved flow of traffic through a work zone or better protection of the workers. Make sure to get formal approval from the Regional Traffic Engineer to test and evaluate the idea in the field if it is a deviation from the Maintenance Manual or MUTCD. This will limit WSDOT's liability if a motor vehicle accident occurs during the testing.

Enforcement

Maintenance supervisors should encourage law enforcement officers to patrol through work zones as frequently as possible. The presence of law enforcement near work zones increases safety and motorist compliance with traffic control regulations.

Contractual use of law enforcement in work zones is based on a combination of local knowledge, sound judgment, and the advice of the Regions' Traffic Engineering staff. Consider the type of work activity, complexity of the traffic control plan, possible speed reduction needs, traffic volumes, nighttime work activity, geometric conditions, associated cost for use of enforcement (cost benefit analysis), and actual traffic problems observed as the work progresses.

Refer to Instructional Letter IL 4008.00 for specific guidance on the use of WSP traffic control assistance.

An agreement GC 9131, between WSDOT and WSP exists to keep the payment process consistent statewide. Maintenance offices charge enforcement work to the particular work order number for the control section where the work is done. Contact the Region Traffic Office for assistance with WSP traffic control assistance.

Resources for Traffic Control and Work Zone Safety

The following information may provide additional guidance and more specific detail. This list includes manuals, reference documents and staff mentioned throughout this chapter.

- Work Zone Traffic Control Guidelines M 54-44 (required for each crew)
- MUTCD Part VI (required for each crew)
- Traffic Manual, Chapter 5, M 51-02
- Work Zone Safety Task Force Recommendations
- Quality Standards for Work Zone Traffic Control Devices (ATSSA)
- Work Zone Traffic Control Supervisors Notebook
- Planning and Scheduling Work Zone Traffic Control (FHWA IP-81-6)
- IL 4008.00 WSP Traffic Control Assistance
- Directive D 55-20, Reduced Speed in Maintenance and Construction Work Zones
- Region Maintenance or Traffic Office and Public Information Officer (Traffic Engineer or Traffic Control Specialist)
- HQ M & O Traffic Office, State Traffic Control Engineer

General

The roadway is the paved or otherwise improved portion of a public highway ordinarily used for vehicular travel. The roadway surface is normally classified as rigid (consisting of Portland Cement Concrete) or flexible (consisting of asphaltic materials).

A smooth surface with good skid resistance, free of alligator cracks, pumping, pushing, wheel rutting, raveling, frost heaving, and pot holing, is desirable for safe travel by the people we serve.

Maintenance of the state's roadways must include a program to preserve these characteristics. Ideally, the maintenance of pavement should be accomplished with minimum expense and with the least possible traffic disruption. Maintenance of pavements is a necessary investment made to protect the pavement from costly renovation or reconstruction.

Preventive maintenance is much more cost effective than performing major repairs. Area maintenance staff are required to inspect each section of highway at least once a year to detect and schedule deficiency repairs prior to their becoming a major problem.

A biennial appropriation corresponding with a specific, (LOS) Level of Service for roadway maintenance and operations activities is provided by the Washington State Legislature. The maintenance area's roadway surface program should be managed to meet these LOS commitments. In doing so, it is essential that each Area work with its Program Management, Design and Construction offices to ensure that the work being planned is coordinated with the work that these offices are planning and/or constructing.

It is advised that written recommendations for pavement repairs be submitted to the Regional Maintenance Engineer. The Regional Maintenance Engineer then shares the region wide roadway surface maintenance program with the Regional Construction Engineer. This allows better coordination between the maintenance and construction programs.

Pay special attention to the drainage of roadway sections when planning maintenance activities. Poor drainage can lead to premature aging of the roadway surface and sub-grade.

Work zone safety and traffic control are extremely important. Maintenance employees are required to know and closely follow the chapter in this manual on traffic control and safety.

Maintenance of Flexible Pavements

Flexible pavements generally are referred to as asphaltic concrete pavement (ACP) or bituminous surface treatment (BST). Flexible pavements develop strength from the tight interlocking of crushed rocks with an asphalt material binding them together. This mixture deflects when loaded by traffic and exerts pressure on the subgrade. Consequently, both the pavement and the subgrade must be in good condition to avoid maintenance problems.

Load & Speed Restrictions

If the subgrade temporarily lacks strength to carry heavy loads due to excess moisture and/or thawing, any class of vehicles can be restricted by weight and/or speed. Maintenance staff must monitor the roadway condition during threatening weather conditions. Take action according to directive D 54-43 (MR), Emergency Restrictions for Roads, before the subgrade becomes saturated and soft. This will avoid unnecessary stress which can lead to permanent damage.

Restrictions should be no more severe or of longer duration than necessary to protect the roadway. Consider the economic effect to the users. The damage caused by failure to place restrictions on soft roadways can have a severe effect on a maintenance budget and their ability to meet LOS targets.

Pavement Deficiencies

Damage and deterioration of pavements will become apparent in a variety of ways. A number of factors can contribute to the appearance of pavement deficiencies. For example, an overlay with excess asphalt or poorly graded or inadequately fractured paving material may not have adequate particle interlock; thus pushing, rutting, & humps may develop. Poor subgrade drainage, heavy tonnage, and accelerating or decelerating traffic are all potential sources of surface irregularities. Pavement deficiencies are explained in more detail as follows:

Rutting

Rutting is a surface depression within the wheel path and is a result of permanent deformation of the pavement or subgrade. This condition is normally caused by heavy loads on roads lacking sufficient strength to support the loading. In some cases, rutting can also be caused by studded tire use. Wheel ruts, if not repaired, can trap water and cause hydroplaning.

Alligator Cracking

The condition known as alligator cracking is attained when discontinuous longitudinal cracks begin to interconnect to form a series of small polygons that resemble an alligator's skin. This distress is usually caused by poor drainage, poor mix design, or subgrade failure.

Ideally the surface should be treated with a seal coat or overlaid with suitable material before water has an opportunity to penetrate the surface and lead to alligator cracking. If it is neglected and alligator cracks appear, heavy traffic can push the surfacing rock into the wet soil beneath it. This forces mud up through the asphalt surface (pumping) causing permanent damage that can not be repaired by a seal or overlay. Spots where severe pumping has occurred will often need to be dug out, and the base rock, surfacing rock, and asphalt replaced.

Longitudinal Cracking

A longitudinal crack follows a course approximately parallel to the centerline. These are typically resultant of natural causes or traffic loading.

Transverse Cracking

Transverse cracks run roughly perpendicular to the roadway centerline. They may be due to surface shrinkage caused by low temperatures, hardening of the asphalt, or cracks in underlying pavement layers such as PCCP slabs. They may extend partially or fully across the roadway.

Potholes

Potholes are voids in the roadway surface where pieces of the pavement have become dislodged. Areas in which many potholes occur become suspect for fundamental problems such as inadequate drainage, pavement strength, or base/subgrade problems. Single or infrequent potholes may be the only pavement distress to occur in an area, and beyond the treatment of the individual pothole no other pavement repair work may be required.

The location of potholes which receive a temporary fix should be documented so they are addressed as part of the Area's annual permanent fix program. The number of potholes that appear in the wet or winter seasons is often an indicator of the effectiveness of the permanent fix program.

Raveling & Pitting

Raveling and pitting distresses are characterized by the loss or dislodgment of surface aggregate particles. Oxidized asphalt binder is often the cause of raveling and pitting. It could also be caused by poor compaction, letting the mix get cold when paving, dirty aggregate, not enough asphalt in the mix, overheating the mix during manufacture, or aging.

Routine maintenance repairs are made to raveled or pitted surfaces as soon as conditions permit and/or materials are available. The most important consideration in scheduling repair of raveled or pitted areas is to perform the repairs before a more serious condition develops, and prior to the onset of inclement weather.

Open grade pavements that allow water to drain through and out the side don't need to be sealed if they are properly constructed. But, pavement that is raveling must be sealed. Unsealed pavements will continue to ravel and will also age and harden at a much faster rate than normal. This condition may also encourage the loss or stripping of the asphalt within the pavement. Timely sealing can add significantly to the life of the pavement. Open grade pavements should be fog sealed on a schedule recommended by the Region Materials Engineer. Failure to do so can lead to premature failure of the open grade mat and lead to difficult maintenance problems.

Flushing

Flushing (or bleeding) is free asphalt on the surface of the pavement caused by, too many fines in the mix, too few voids, too much asphalt in patches, or a chip seal that has lost its rock. This type of distress often shows as a shiny, glass-like reflective surface. It is inherent to unstable mixes and often results in other roadway surface distresses if not corrected.

Removal and replacement of flushed or bleeding pavement areas is an expensive, but sometimes cost-effective method of repair. Thin overlays of flushed or bleeding areas will frequently have the “fat spot” show through in hot weather and exhibit the same characteristics as in the “before” condition. If repairs are not possible prior to a seasonally wet period, contact the Regional Traffic Engineer to evaluate the need for posting “Slippery When Wet” signs.

Sags and Humps

Sags and humps are localized depressions or elevated areas of the pavement that result from settlement, pavement shoving, displacement due to subgrade swelling, or displacement due to tree roots. The deficiency usually occurs in isolated areas of the roadway surface.

Edge Raveling

Edge raveling occurs when the pavement edge breaks and is most commonly found on those roadways that were constructed without curbs or paved shoulders.

Pavement Maintenance Techniques

Patching

All flexible pavements require patching at some time during their service life. Surface patching should be performed to a standard commensurate with resource availability and the objective of retaining a smooth ride as long as possible. Since patching materials are one of the larger material costs a high quality patch is one of the most cost effective means of utilizing available resources.

There are two principal methods of repairing asphalt pavements:

1. Remove and replace the defective pavement and surfacing or base material.
2. Cover the defective area with an overlay of a suitable material to renew the surface, seal the defective area, and stabilize the affected pavement.

These repairs can be called ‘dig-outs’ or ‘overlays’ according to the method used.

Patching with Base Repair

‘Dig-out patches’ are used for making permanent repairs to the pavement. Defective pavement and unstable surfacing materials are removed down to a stable base. This may mean removal of some of the subgrade material. The excavated area should extend into the good pavement around the defective area by about 12 inches. Cut the edges of the patch area vertically and in straight lines to provide a good line for compaction later. A pavement saw makes a good tool for a fast, neat cut in pavement patching.

After the cut is made and the defective pavement and/or base material is removed, level and compact the base material. This will make an adequate foundation for the new asphalt concrete material. Surfacing materials (gravel base, crushed surfacing) and pavement must always be replaced in depths at least equal to the original design or by additional depth of ACP compacted in lifts of (1) to (3) inches. Apply a tack coat of asphalt to the vertical sides of the hole to assure a good bond and seal between old and new pavements.

For best results in a patch of this nature, back fill the hole with a hot plant-mix material such as Asphalt Concrete Class B. The asphalt should be compacted in lifts of no more than 3 inches thick to obtain optimum patch life. Small patch projects can be compacted with a vibrating plate compactor, while a roller works best on large patches. During hot weather it might be advantageous having some water on hand to help cool the mix between lifts. Standing water should not be allowed on the mix between lifts.

After the intermediate lifts of the patch have been compacted sufficiently, the surface lift can be completed. Take special care to ensure that it is compacted to be even and flush with the surrounding surface, so it provides a good riding surface. Some compaction will occur by traffic as the mix is further kneaded into place. The patch should be cool enough before traffic is allowed on it, so it will not leave marks in the surface. Deeper patches will require more time to cool and must be planned for accordingly.

Potholes and localized failures should be repaired as soon as possible after they are reported. Asphalt pre-mix (cold mix) should be available throughout the year so any potholes that appear can be patched immediately. Fiber reinforced, and other specialized 'winter mix' have been found to be effective in many locations. Many times the use of a propane torch to dry the holes and heat the mix for good compaction is time well spent.

The use of an asphalt 'tack' is highly recommended. A higher success rate is normally achieved when they are squared up and tack is added to the edge of the pothole. If the lack of availability or storage of standard tack is a problem, try using one of the cold pour crack pouring materials. They are available in (5) gallon buckets with a pour spout. Many pothole patching crews use this as standard procedure.

Don't use sand, clay, or other temporary patching material to patch or "pad" potholes or frost boils. On today's roads these methods usually cost more in the long run and often leave unsafe conditions for the traveling public. Asphalt pre-mix is the preferred method, even if it has to be replaced when final repairs are made.

For permanent pothole patching proceed as follows:

- Remove the defective material down to a stable base
- Square off the edge of the hole vertically
- Dry the hole as much as possible (fiber reinforced mix often does well in wet holes).
- Tack the hole if possible
- Place and compact the mix

Compaction is very important in making the repair permanent (heat applied to the mix is very beneficial to good compaction). If traffic is picking the fresh mix out of the hole try dusting the finished patch with some roadside dirt. Spend a little more time patching the pothole the first time. This will often keep you from returning to patch the same hole repeatedly. Permanent repairs are normally made with hot mix if available.

Overlay Patches

Overlay patches are generally applied when an area is too large to be economically repaired by hand with a small crew. The overlay patch, with hot plant-mix asphalt, also has the advantage of setting quickly. It does, however, commit a considerable investment in labor, equipment, and materials.

Typically, overlay patches are applied in areas of pavement failure or wear problems rather than areas with a base or subgrade problem. Ruts, raveling, pitting, minor cracking, and oxidation are typical failures where overlay can be effective in quickly and permanently restoring the surface. When addressing pavement rutting, mix should be placed in lifts when patching rutted areas in order to get uniform compaction. This method of compaction will help prevent the rut from reflecting into the finished patch. To obtain proper compaction in the wheel ruts, a rubber tired roller should be used. Steel wheel rollers will bridge the rut and very little compaction will occur. After the ruts are filled and if it is decided to overlay the entire lane then a steel wheel roller would be used for compaction.

Application of any overlay patch requires a considerable degree of skill, coordination, and planning. All loose, broken asphalt should be removed and replaced. Any deep ruts, depressions, or humps should be repaired or pre-leveled in advance of the overlay so that the overlay may proceed efficiently. It is necessary to repair these areas prior to the overlay in order to provide an even platform for the new pavement. This is essential to proper compaction and consequently to pavement life. If, for instance, wheel path ruts are overlaid without pre leveling, the ruts will not get the same compaction from rolling that the thinner high spots will. Then traffic wheel loads will eventually compact the deeper new sections, causing ruts to reappear. All areas should be tacked before patching to ensure a good bond and minimize raveling in thin areas. The tack rate should be 0.4 to 1.4 gallon per square yard of applied tack (0.2 to 0.8 residual).

Be careful when repairing the roadway surface in an area of unpaved shoulders. Widening over thin gravel or dirt shoulders will usually lead to cracking and failure. This is because of the lack of sufficient top course material. If there is the need to

widen the paved roadway, make sure the shoulder is prepared properly to support the anticipated loading.

Spreader Box Patching

On small paving jobs it is often convenient and economical to use a tow-behind paver, or spreader box. These pavers hook to the rear of the trucks that are hauling the mix. The asphalt is dumped directly in the hopper of the paver which places it on the roadway or base material.

As the towing vehicle moves ahead, the mix is struck off by an adjustable height blade (cutter bar or screed) and is surface-finished by the screed. Starting the paving at full depth requires setting the screed on blocks before filling the hopper. The hopper should be kept uniformly full during paving to ensure an even spread. An even towing speed is necessary to maintain a uniform spread thickness.

Spreader boxes vary greatly in size, operating controls, accessories, and capabilities. Working with them requires skill and experience. Manufacturers and construction equipment dealers can provide assistance in the operation and care of particular models.

Clean-up of equipment and tools after each day's operation is essential to good patches. This is especially true of the spreader box. It must be kept free from the accumulation of cold asphalt. Diesel is generally the most common and effective release agent used for cleaning tools and equipment. However, the diesel-asphalt waste mixture must be captured (i.e. not allowed to spill on the ground) and placed into (55) gallon containers for disposal as a "Dangerous Waste". A "Dangerous Waste" label should be placed on the waste container and the date entered as to when the accumulation began.

Spreader box patching with hot plant-mix material has the advantage of providing a smooth finished surface, when the equipment is properly operated. Several people are required to operate a spreader box efficiently. Careful planning of the patching operation is very important to economical and cost-effective pavement maintenance. The spreader boxes can work well if surface irregularities are pre-leveled with equipment appropriate for the conditions. The entire surface should be tacked, both before pre leveling and before starting the spreader box patch.

Rolling of the hot plant-mix should begin immediately after placement of the mix. If the mix is allowed to cool below 185 degrees before rolling, adequate compaction will not be possible.

Grader Patching

Road graders are a useful pavement patching tool. These graders vary in size, model, and capabilities depending on their intended use.

One efficient way of blade patching is using two graders facing each other. This method is quicker than the single blade method, and can help in getting the patch laid before the mix gets cold. It helps keep coarse mix away from the ends of the patches, making smoother approaches, and helps keep a straighter edge. Also, a two grader operation offers a good opportunity to train inexperienced grader operators.

Hot plant-mix patching with graders is frequently accomplished when it is not practical or economical to use other means. Graders are especially valuable for leveling to eliminate sharp depressions or sags and to lay a leveling course of pavement prior to placing finish courses with asphalt spreader boxes. They are excellent to place a leveling course to restore the roadway grade and shape when it cannot be done with a paver or spreader box. All of the area to be blade patched should be tacked. Road graders with a long wheel base and smooth-tread tires are often used for spreading hot plant-mix asphalt in leveling operations. The roller must follow the grader immediately after the mix is spread while it is still hot.

Graders are not efficient at carrying large quantities of material over long distances, so the dumping of asphalt should be carefully controlled for an efficient operation. A dump person should be utilized. Make as few passes as possible with the grader to reduce segregation of the material.

Rolling Hot Mix Patches

It is always desirable to use the most effective tools for the job at hand, including asphalt work. The use of a finish lute person on the patching crew is highly desirable. The quality and ride of the patch is often much better due to their expertise. If short handed, consider borrowing people from an adjacent section so you can provide a quality product. Since patching is one of the most expensive operations to perform, it is essential to develop work schedules that ensure the following are present: desirable weather conditions, adequate staffing and proper equipment.

A ten ton or larger steel-wheeled roller is valuable to an efficient asphalt patching operation. A lighter vibratory roller is a poor substitute, as it can slow the operation considerably. On larger paving projects, one roller may be used to do the breakdown rolling or initial compaction, with another used for the finish rolling.

The patching operation should match the speed of the roller. If the patching crew outpaces the roller, it forces the rolling of mix that is too cold and a poorer quality patch can result. If the operation needs to move faster and the roller can't keep up, use a larger roller or a second roller. Do not compact hot mix asphalt concrete at a temperature below 185 degrees F. Rolling mix that is too cold can cause it to crack. Rolling mix that is too hot can cause pushing. The maximum temperature of mix from the plant is 350 degrees.

Compaction is among the most important phases of the operation. All asphalt concrete patches, small or large, must be compacted to consolidate the material. The properly compacted asphalt patch will be tough and dense and will stand up to the wear of traffic and weather much better than if compaction is inadequate. However you compact the mix, do it well; it is very important.

Rolling for compaction should begin as soon as the paving material is laid. The initial rolling or “breakdown” gives the highest percentage of compaction of any rolling phase. Consequently, it also offers the most potential for material displacement at the edges. It is important to make the initial breakdown pass at least 4 inches away from the edges of the mat. A subsequent pass will level this edge.

Avoid stopping the roller or reversing direction on the hot mat. Do not turn on the mat while moving. This can affect the ride of the patch.

Intermediate rolling further compacts and seals the surface. Finish rolling removes any roller marks and other blemishes left by prior rolling.

Various roller types are used in asphalt compaction. Steel-wheeled, vibratory, and pneumatic tired are the types most commonly available. Steel wheeled and vibratory rollers are used for all three phases of asphalt rolling. Vibratory rollers should not be operated on thin lifts and so are not generally used in maintenance patching operations. Rubber-tired rollers are not normally used in maintenance operations.

All rollers used in asphalt paving or patching operations should be:

- In good operating condition.
- Used according to the manufacturer’s recommendations.
- Capable of reversing direction without backlash.
- Able to operate at speeds low enough to avoid displacement of the hot asphalt.

Do not use rollers producing pickup, washboard, uneven compaction, or otherwise undesirable effects. Vibratory rollers under vibration should not exceed (3) mph. Steel-wheeled rollers should be limited to (4) mph and pneumatic tired rollers to (5) mph maximum. The drive wheel of the roller should always be pulling the roller to prevent displacement and pushing of the material. This is particularly important on steeper grades and in breakdown rolling passes.

Effects of Traffic on a Patching Operation

Timing is critical while doing hot asphalt mix patching. Cold asphalt mix yields inferior patches. Flaggers must avoid delaying asphalt trucks and paving equipment while hot mix patching. Don’t let traffic drive on any unrolled mix. A finished patch should be cool enough to hold your hand on before traffic is allowed to drive normal speeds on it. A pilot car offers a big advantage for multiple patches over an extended section of roadway. The use of a third flagger to keep traffic off the

unfinished mix and away from the equipment is desirable. Traffic striping that is blacked out or covered should be remarked the same day for safety reasons.

Crack Sealing (or Pouring)

There are significant costs involved in filling cracks, both for materials and labor, the supervisor needs to be aware of the nature, extent, and severity of the cracking problem and also of the next scheduled contract for resurfacing. Filling cracks in an area scheduled for immediate reconstruction or resurfacing by contract is not recommended unless it is a part of the overall project. Minor repair and crack sealing is often part of the contractor's responsibility. However, sealing minor cracking may extend the useful pavement life for several years when an overlay project is not scheduled.

Generally, alligatoring or more general cracking can be repaired most cheaply by chip seals. Serious cracking and settlement of the pavement may indicate the need for excavation to repair the subgrade before patching can be successful.

The main purpose of crack pouring is to prevent water from entering the subgrade and causing damage. There are two widely used types of crack pouring material in highway maintenance, hot pour and cold pour. The two types use different techniques and equipment. The purpose of the two is the same, to minimize water entry and resulting damage.

Over-poured cracks can be a safety hazard to motorcycles. Overband (over-poured) crack pouring, especially on longitudinal cracks, can cause loss of control for motorcycles. The problem is compounded on curves or when the surface is wet. Cracks that are not over filled do not seem to cause a problem. Areas that have excessive crack pouring material from past practices should be addressed.

Hot Pour Method

This method utilizes blocks of crack pour material heated in specialized crack pouring machines. The most common type in maintenance are trailer mounted, oil jacketed units. This method is often used by contractors and maintenance crack sealing distressed areas that are not going to be removed and repaired prior to an overlay. It is a common method of sealing the joint between the edge of a PCC road surface and the asphalt shoulder. It works well for large volume work involving large cracks. Often the cracks are routed out first. If not, they should be cleaned and dried with compressed air prior to pouring. Filling cracks with this method requires a large crew and specialized equipment.

Safety is a big concern in a hot crack pour operation. This material is extremely hot and can cause severe burns when loading the machine or applying the material.

Cold Pour Method

This method utilizes cold applied liquid material and does not require specialized equipment. This type of material is available in five gallon to fifty gallon

containers. It can be sanded lightly after application and opened to traffic. One person can apply it using the spout on the five gallon bucket it comes in.

Experience has shown that for maintenance purposes cold pour seems to prevent water entry into the subgrade as well as hot pour material. It also resists build up on bumps better than the hot material does.

Cold pour is excellent as tack for small asphalt patches and pothole repairs. It greatly simplifies the problems of tack storage, transporting, and application. A sealed five gallon bucket can be carried easily by a pothole patching crew.

This material works well for hand pouring the cracks around an isolated bridge drain or catch basin if a piece of foam 'backer rod' is poked down into the crack before pouring to serve as a bottom for the material. It can also be poured against rubber expansion joints without melting the rubber joint.

Maintenance of Rigid Pavements

Rigid pavements are generally referred to as Portland Cement Concrete Pavement (PCC). PCC pavements should be patched with Portland Cement Concrete or one of the WSDOT approved patching materials. Prepare and apply patching materials according to the manufacturer instructions. If recommended by the patching material manufacturer, use a bonding agent.

The PCC surface to be repaired should have all loose material removed down to solid material or to full depth if necessary. A jackhammer or similar equipment may be necessary to remove some of the material in the area to be patched. The area to be repaired needs to be squared by concrete sawing, then sand blasted, cleaned and dried.

Delamination occurs when a thin layer of surface concrete has lost bond with the underlying concrete. The area around the patch should be checked for delamination. Tapping on the surface with a hammer and listening for a hollow sound is one way to find the delaminated areas.

If reinforcing steel is encountered, remove or neutralize all rust. Coat exposed reinforcing steel with a WSDOT approved product to prevent rust from reoccurring. Then proceed with patching the area.

Traffic should be kept off the new patch as specified by the manufacturer, until it gains sufficient strength to support traffic.

Portland Cement Concrete Pavement Crack Pouring

Joints in Portland Cement Concrete Pavements (PCC) compensate for thermal movements of the pavement and provide load transfers between slabs. Properly sealed joints in concrete pavements prevent water from entering into and weakening the underlying base and subgrade materials. Properly sealed joints

Patching and Pavement Repair

also prevent incompressible materials such as dirt and gravel from penetrating into joints, which then restricts thermal joint movements. Materials that restrict the natural expansion of the pavement joints can cause diagonal slab cracking, slab blowups, or tipping and spalling.

PCC joints and cracks should be checked before the wet season to make sure they are sealed to prevent entry of damaging water.

Even fine cracks in steel reinforced slabs can be serious. They can allow water or chlorides to reach the steel causing corrosion and serious damage.

PCC crack pouring is most effective when the pavement is cold and has contracted and opened the cracks. Don't pour cracks when the pavement temperature is below 45 degrees. Always use WSDOT approved crack sealant material.

Cracks must be routed out before pouring. If not, they should be cleaned and dried with compressed air prior to pouring. Foam backer rod can be used in larger cracks to keep the sealant in the top (1) inch of the crack.

Safety is a big concern in a hot pour operation. This material is extremely hot and can cause severe burns when loading the machine or applying the material.

ASPHALT CONCRETE PAVING QUANTITIES (TONS/100 LIN FT)

WIDTH (FT)	DEPTH OF MIX (COMPACTED)					
	1"	2"	3"	4"	5"	6"
2	1.2	2.4	3.6	4.8	6	7.6
4	2.5	5	7.5	10	15	15.2
6	3.8	7.6	11.4	15.2	19	22.8
8	5	10.1	15	20	25	30.4
10	6.3	12.6	18.9	25.2	31.5	38
11	7	14	21	28	35	42
12	7.6	15.2	22.8	30.4	38	45.6
16	10.1	20.2	30.4	40.6	50.7	60.8
18	11.4	22.8	34.2	45.6	57	68.4
20	12.4	25.2	37.2	49.6	62	76
22	14	28	41.8	56	70	83.7
24	15.2	30.4	45.7	60.8	76	91.3

MIX QUANTITIES IN PATCHES

MIX CLASS	SIZE	
CLASS A	5/8"-0"	higher grade mix, more fractured rock, has good strength
CLASS B	5/8"-0"	standard mix in many areas
CLASS D	3/8"-0"	open grade mix, used in thin overlays, can ravel bad as it ages
CLASS E	1 1/4"-0"	coarse mix
CLASS F	5/8"-0"	lower grade mix, less fracture, more round rock, contains more fines & has less strength
CLASS G	3/8"-0"	fine mix, good for wheel ruts & skin patches
ASPHALT TREATED BASE MIX	2"-0"	specs allow down to 1/2" maximum size rock

CLASSES OF ASPHALT CONCRETE PAVEMENT (ACP)

Sources for Additional Pavement Maintenance Information

Asphalt Institute publications:

- MS-4 The Asphalt Handbook
- MS-5 Introduction to Asphalt
- MS-8 Asphalt Paving Manual
- MS-14 Asphalt cold-Mix Manual
- MS-15 Drainage of Asphalt Pavement Structures
- MS-16 Asphalt in Pavement Maintenance
- MS-17 Asphalt Overlays for Highway and Street Rehabilitation
- MS-19 Basic Asphalt Emulsion Manual

WSDOT Publications:

- Standard Specifications for Road, Bridge, and Municipal Construction (M 41-10)
- Construction Manual (M 41-01)
- Design Manual (M 22-01)

Asphalt Emulsion Surface Treatment

Preventive maintenance programs started early in life of a pavement (1-3 years) provide the protection needed to greatly improve service life. For aged pavements, surface treatments can delay the costs of major reconstruction. Asphalt emulsion surface treatments are excellent for preventing the development of early pavement damage or distress. The surface treatment seals the pavement, retards the aging process and prevents the old pavement from further hardening. One method of sealing minor cracks and providing a renewed roadway surface is called Bituminous Surface Treatment (BST). BST is used to seal small cracks, repair a dry raveling surface and provide a skid resistant surface.

Fog Seals

In instances of a pavement with very minor raveling, a fog seal may adequately seal the pavement and prevent further raveling. Fog Seals are very light applications of diluted, quick breaking asphalt emulsions. Some of the asphalt materials used for fog seals are: CSS-1 and STE-1 which are cationic (positively charged) emulsions, while HFE-100S-50% diluted is an Anionic (negatively charged) emulsion. These products may require cover material (1/4 - 0) depending on the surface and application rate. The decision whether to use a cationic or anionic formulation should be based on knowledge of the charge of the existing materials used as part of the pavement. Understand that like charged materials repel each other and opposites attract. We want the materials to attract each other and make a tight bond. The Region or the Headquarters Materials Lab can assist in the determination.

Asphalt emulsions used for fog seals are usually diluted 50% with water or other types of cut-backs as prescribed by the manufacturer. The Fog Seals are applied at the rate of 0.1 to 0.2 gallons (of diluted material) per square yard, depending on the texture and porosity of the old pavement. The application rate will be determined by the amount of emulsion the old pavement surface can absorb without becoming slippery. Traffic control may be required for up to two hours, depending on location and volume of traffic.

Sand Seal

Where more raveling has occurred, a sand seal may be needed to adequately seal the surface and provide a quality surface. A sand seal is an application of liquid or emulsified asphalt covered with fine aggregate. It is used to seal against air and water infiltration, or improve skid resistance. Applications are 0.1 to 0.2 gallons of CRS-2 or CMS-2 per square yard covered with ten pounds of 3/8 minus aggregate. Some regions have found 1/4 minus to be better suited for sand seals.

Aggregate (Chip) Seal

If the raveling becomes more advanced, an aggregate or chip seal may be needed. In cases where raveling is allowed to progress to the point where the ride is affected, a thin overlay, or pre-leveling followed by a chip seal, might be needed. An aggregate seal is a single spray application, usually of a liquid or emulsified asphalt. Immediately following is a single layer of aggregate of as uniform a gradation (size) as practicable. This type of seal reduces the infiltration of air and water into the mat and may be used to improve skid resistance of slippery pavements.

Chip seals are useful and can be applied in many different ways: Full lane width, partial lane width, short longitudinal sections or for long sections.

A typical example of a BST uses application rates for CRS-2 or HFE-100S at .40 to .60 gallons/per square yard with 30 to 40 pounds of 5/8 - 1/4 Crushed Cover Stone per square yard. Look in the Standard Specification Manual, section 5-02, 9-02, and 9-03.4 for additional information on Bituminous Surface Treatment and materials.

Pavement Conditions for a Successful Project

Prior to sealing thoroughly, examine the roadway surface. Then decide what kind of repair is needed. A chip seal does not add to the structural integrity of pavement. Therefore, the existing pavement must be structurally sound in order to obtain a long performance life. Existing pavements may have to be repaired; patched, crack sealed and then allowed to cure before a chip seal can be applied. Always clean the existing roadway surface before starting the chip seal process.

Since chip seals follow the original profile of the pavement, they do not correct surface irregularities. Chip seals cannot be used on pavements with more than 3/8" to 9/16" of rutting. Aggregates in the ruts can not be fully compacted. Cleaning loose aggregate from the rut with a power broom will dislodge the aggregate from the non-rutted area. If the surface has light-to-moderate bleeding, the binder application rate should be reduced. Don't use a chip seal on pavements with a high severity of bleeding.

Material Selection

Asphalts and Emulsions

The two general types of asphalt for seal coating are liquid asphalt and emulsified asphalt. Liquid asphalts are graded by viscosity. SC-Slow Cure-70, MC-Medium Cure-70, RC-Rapid Cure-70, have the lowest viscosity. SC, MC, RC 3000 have the highest viscosity. Liquid asphalts are also graded by the type of solvent used to thin them: SC with light oil, MC with kerosene, and RC with naphtha cutback. MC 3000, RC 3000, or RC 800 are the liquid asphalts used for chip sealing. Emulsified asphalts are manufactured by suspending asphalt particles in water with the aid of an emulsifying agent. Asphalts for Bituminous Surface Treatment are listed in the Standard Specification Manual. (9-02)

Common Types of Emulsions Used for Chip Seals

CRS-2 (Cationic Rapid Set Emulsion) is one of the most widely used emulsions. This emulsion will run into wheel ruts and down super elevated roadways if applied at rates above 0.4 gallons per square yard. CRS-2 provides a good seal on low volume highways.

HFRSP2/HFE-100S (Anionic Styrelf Polymer High Float Emulsion) is used for chip seals. It is a rapid setting emulsion that binds the chips very fast and can be used on high volume roads. This product should not bleed under high pavement temperatures.

Aggregate

Aggregate for bituminous surface treatment must conform to the requirements in the Standard Specifications Manual 9-03.4 for grading and quality. The material must meet the requirements for grading and quality when placed in hauling vehicles for delivery to the roadway. During manufacture and placement into a temporary stockpile the exact point of acceptance will be determined by the Engineer or Area Superintendent. The finished product shall be clean, uniform in quality, and free from wood, bark, roots, and other contaminants. Crushed screenings must be substantially free from adherent coatings.

Weather

The best time of year for a seal coat is when the weather is hot and dry during, and for some weeks after, treatment. Specifications require the air temperature in the shade to be at least 60 degrees Fahrenheit before work begins. No matter what the temperature of the asphalt when sprayed, it will cool to the temperature of the pavement surface in one minute. BST treatments should be placed between May 15th and August 15th for best results.

Never start a BST when the surface is wet or when it is threatening to rain. If the fresh seal gets wet, the combination of water, fresh seal coat, and traffic will result in loss of the cover aggregate.

Roadway Preparation

The surface should be thoroughly cleaned of all loose materials prior to application of asphalt. Sweep the roadway surface before starting the job. This allows the dust to be either flushed with water or blown off the roadway surface by traffic.

If patching is needed, allow time for the patch material to cure prior to sealing. Generally, two weeks should be allowed for hot mix to cure. Allow six weeks at temperatures of 50 degrees to 60 degrees Fahrenheit for cold mix to cure. To preserve the centerline location place flexible reflective markers prior to the seal. These can also be used to indicate the beginning and end of no passing zones. Flexible reflective markers have a removable cover so that they retain their reflectivity after the seal. They will also function as guidance for the striper truck.

Equipment

Before any work begins, examine all equipment to ensure it is in good working condition. Check spreader boxes or aggregate spreaders to see they are in proper working order. The roller operator should make sure that each tire on the roller is equally inflated to correct pressure and that controls for steering, starting, and stopping operate smoothly. All tires should be the same size and the water spray and scraper system must be checked to ensure material does not bond to the tires.

Distributor

New distributors use a ground speed control sensor and computer to regulate material application rates. Set the computer to the desired rate and the application will be correct even if the vehicle speed varies.

Older distributors are equipped with hydrostatic drive systems. The hydrostatic drive consists of a variable output pump driven by the truck power take off (P.T.O.). This in turn drives the distributor asphalt pump with a hydrostatic motor. Once the correct ratio between ground speed and pump flow rate is established for a given transmission setting, the truck ground speed may be varied without affecting the application rate. The operator needs a dry run to establish correct ratio between pump flow rate and ground speed.

Determine from the road computer (Slide Rule) the correct ground speed (F.P.M.) and pump flow rate (G.P.M.) for the desire spray bar length (FT.) and application rate (GAL/SQ.YD.). Follow the correct operation procedures set up in your distributor manual for calibration.

Calibration Procedures

Distributor Calibrations

Step 1

Calculate how much material is in the holding tank. The following methods work to calibrate an older distributor and calculate the application rate.

Method 1

Determine the number of gallons in the distributor. This can be done by several methods. The first and most accurate is to weigh the distributor before loading and after loading. Subtract the weights and divide by the pounds per gallon the emulsion weighs. This equals the total gallons.

Method 2

Find a level spot (the distributor tank must be level). Use a dip stick to dip the tank. Measure the number of inches covered with asphalt. After you know the size of the tank, you can calculate the number of gallons in the tank.

Method 3

Use the meter on the distributor tank. This is a good method for checking the above calculations but is **not recommended** for calibrating purposes.

Methods 1 and 2 are recommended for Measuring Distributor Tank (MDT) equipment prior to the start of the project.

Step 2

Apply asphalt to a known distance (minimum 200 feet) and established width.

Step 3

Determine the total square yards covered with emulsion. This can be done by doing the following calculation:

$$\underline{\text{Length Traveled (feet)}} \times \underline{\text{Width Covered (feet)}} = \text{Square Yards}$$

Step 4

Determine the number of gallons remaining on the distributor. Again use Method 1 or Method 2 explained in Step 1.

Step 5

Subtract the total gallons on the distributor originally from the total gallons left on after applying asphalt. This will give the gallons used.

Step 6

Divide the total gallons used by the total square yards covered:

$$\frac{\text{Total Gallons}}{\text{Total Sq. Yd}} = \text{Gallons/Sq. Yd.}$$

Step 7

To check your application rate on the project, follow the same steps except use Method 3 outlined in Step 1 to determine the number of gallons on the distributor.

Nozzle Size

The spray bar and nozzles are an important part of the distributor. The proper quantity of asphalt must be spread uniformly on the road surface through the spray nozzles. To achieve good results, correctly sized nozzles must be selected for the job conditions. For example: if nozzles are too large for the desired application, pulsation of the spray may occur, resulting in uneven longitudinal spreading of the asphalt.

Each equipment manufacturer has specific recommendations for the size of spray nozzles to be used for different applications. Use the manufacturer's recommendation when choosing the correct nozzle size. All nozzles selected for use at any one time should have the same size opening.

Proper Pressure

The spray bar must have a constant, uniform pressure along its entire length for equal output from all nozzles. Be sure the spray bar and nozzles are CLEAN.

Although several methods are used to maintain pressure, distributors use gear-type pumps to deliver asphalt to the spray bar. Pressure is governed by variable pump speed on some distributors and by constant pump speed and a pressure relief valve on others. Each application should be checked, as recommended by the manufacturer.

The correct pump speed or pressure are critical to the proper application of the asphalt. Too low a pressure will result in a non-uniform discharge/streaking of material from the individual nozzles. Too high a pressure, in addition to atomizing the asphalt, will distort the spray fan.

When a metering system is used, the manufacturer supplies the distributor with charts for finding the proper pump speed for each application rate.

When a pressure relief valve is used, the pump runs at a constant speed and the pressure is automatically held in the spray bar. The manufacturer supplies charts for determining the discharge in gallons per minute for each size nozzle, the proper truck speeds for various application rates, and the corrections for temperature-viscosity variations.

**GALLONS OF EMULSIFIED ASPHALT REQUIRED PER 100
LINEAR FEET: VARIOUS WIDTHS AND RATES**

Gall. Per Sq. Yd.	WIDTH—FEET														
	1	2	6	7	8	9	10	11	12	14	16	18	20	22	24
0.10	1.1	2.2	6.7	7.8	8.9	10.0	11.1	12.2	13.3	15.6	17.8	20.0	22.2	24.4	26.7
0.15	1.7	3.3	10.0	11.7	13.3	15.0	16.7	18.3	20.0	23.3	26.7	30.0	33.3	36.7	40.0
0.20	2.2	4.4	13.3	15.6	17.8	20.0	22.2	24.4	26.7	31.1	35.6	40.0	44.4	48.9	53.3
0.25	2.8	5.6	16.7	19.4	22.2	25.0	27.8	30.6	33.3	38.9	44.4	50.0	55.6	61.1	66.7
0.30	3.3	6.7	20.0	23.3	26.7	30.0	33.3	36.7	40.0	46.7	53.3	60.0	66.7	73.3	80.0
0.35	3.9	7.8	23.3	27.2	31.1	35.0	38.9	42.8	46.7	54.4	62.2	70.0	77.8	85.5	93.3
0.40	4.4	8.9	26.7	31.1	35.6	40.0	44.4	48.9	53.3	62.2	71.1	80.0	88.9	97.8	107.
0.45	5.0	10.0	30.0	35.0	40.0	45.0	50.0	55.0	60.0	70.0	80.0	90.0	100.	110.	120.
0.50	5.6	11.1	33.3	38.9	44.4	50.0	55.5	61.1	66.7	77.8	88.9	100.	111.	122.	133.
0.55	6.1	12.2	36.7	42.8	48.9	55.0	61.1	67.2	73.3	85.5	97.8	110.	122.	134.	147.
0.60	6.7	13.3	40.0	46.7	53.3	60.0	66.7	73.3	80.0	93.3	107.	120.	133.	147.	160.
0.65	7.2	14.4	43.3	50.6	57.8	65.0	72.2	79.4	86.7	101.	115.	130.	144.	159.	173.
0.70	7.8	15.6	46.7	54.4	62.2	70.0	77.8	85.5	93.3	109.	124.	140.	156.	171.	187.
0.75	8.3	16.7	50.0	58.3	66.7	75.0	83.3	91.7	100.	117.	133	150.	167.	183.	200.
0.80	8.9	17.8	53.3	62.2	71.1	80.0	88.9	97.8	107.	124.	142.	160.	178.	196.	213.
0.85	9.4	18.9	56.7	66.1	75.5	85.0	94.4	104.	113.	132.	151.	170.	189.	208.	227.
0.90	10.0	20.0	60.0	70.0	80.0	90.0	100.	110.	120.	140.	160.	180.	200.	220.	240.
0.95	10.6	21.1	63.3	73.9	84.4	95.0	106.	116.	127.	148.	169.	190.	211.	232.	253.
1.00	11.1	22.2	66.7	77.8	88.9	100.	111.	122.	133.	156.	178.	200.	222.	244.	267.
1.10	12.2	24.4	73.3	85.5	97.8	110.	122.	134.	147.	171.	196.	220.	244.	269.	293.
1.20	13.3	26.7	80.0	93.3	107.	120.	133.	147.	160.	187.	213.	240.	267.	293.	320.
1.25	13.9	27.8	83.3	97.2	111.	125.	139.	153.	167.	194.	222.	250.	278.	306.	333.
1.30	14.4	28.9	86.7	101.	116.	130.	144.	159.	173.	202.	230.	260.	288.	318.	347.
1.40	15.6	31.1	93.3	109.	124.	140.	156.	171.	187.	218.	249.	280.	311.	342.	373.
1.50	16.7	33.3	100.	117.	133.	150.	167.	183.	200.	233.	267.	300.	333.	367.	400.
1.75	19.4	38.9	117.	136.	156.	175.	194.	214.	233.	272.	311.	350.	389.	427.	467.
2.00	22.2	44.4	133.	156.	178.	200.	222.	244.	267.	311.	356.	400.	444.	489.	533.
2.25	25.0	50.0	150.	175.	200.	225.	250.	275.	300.	350.	400.	450.	500.	550.	600.
2.50	27.8	55.6	167.	194.	222.	250.	278.	306.	333.	389.	444.	500.	556.	611.	667.
2.75	30.6	61.1	183.	214.	244.	275.	306.	336.	367.	428.	489.	550.	611.	672.	733.
3.00	33.3	66.7	200.	233.	267.	300.	333.	367.	400.	467.	533.	600.	667.	733.	800.

Note: Formula used for calculation: $Q = \frac{100W}{9} R = 11.11WR$

Where: Q = Quantity of asphalt required, in gallons per 100 ft. (l/m)
 R = Rate of application in gallons per sq. yd. (l/m²)
 W = Width of application, in feet (m)

For metric conversion factors see pages 6-A&B Metric formula for calculation: Q = LWR where L = length in metres.

Spray Bar Height

The height of the spray bar above the pavement surface is probably the most important adjustment to assure uniformity of asphalt spread. Correct height must be maintained during the entire application. If the spray bar is too low or too high, streaking will result.

The preset height above the pavement surface should not vary more than 1/2-inch. The bar will not stay within this tolerance, however, unless the manufacturer or the contractor takes steps to ensure that it does. As the asphalt leaves the spray bar, the load lightens and the springs raise the distributor. If there is an appreciable amount of deflection in the springs, the spray bar can rise as much as 4 inches, resulting in an uneven application.

Excess vertical movement of the spray bar can be corrected in several ways. After the bar height is adjusted with a full load in the tank, the frame of the distributor can be tied down to the axle during the spreading runs. If it is a truck-mounted distributor and has an adjustable type spray bar, mechanical controls can be supplied by the manufacturer to maintain the proper height, regardless of the deflection in the springs. On trailer-mounted distributors, bar height control is not necessary because of the small deflection of trailer springs. In any event, the height of the bar should be checked after each run and any necessary adjustment made at that time.

Triple Coverage: This is where any point on the roadway surface will receive overlapping spray from the two adjoining nozzles.

4-Inch nozzle

Best results with 4-inch nozzle spacing will come from an exact triple coverage of the spray fans. A simple test procedure assures the proper height setting of a spray bar with 4-inch nozzle spacing. One can determine by visual inspection whether or not an exact single coverage of asphalt is being applied. To begin, the second and third, fifth and sixth, eighth and ninth, etc., nozzles are closed, using the center section of the bar only. The distributor is then operated at the correct pump speed/pressure with the spray bar height changed not more than 1/2-inch at a time until the proper height is obtained. When an even single coverage of asphalt, heated to the proper spraying viscosity, is applied to the surface, it will give a uniform triple coverage with all nozzles operating.

6-inch nozzle

The height of bar necessary to give a triple coverage will frequently cause wind distortion of the spray fans, resulting in non-uniform application. A double coverage is therefore recommended for 6-inch nozzle spacing.

Double Coverage: This involves the same procedure as above except that every other nozzle is left open; the remaining ones are shut off. If the distributor has already been checked for double coverage, increasing the spray bar height by 50 percent will give triple coverage.

Proper Nozzle Angle

Adjust nozzle opening angles so the spray fans will not interfere with each other. The nozzle angle will vary according to the make of the distributor. The angle recommended by the Asphalt Institute, measured from the spray bar axis, is 15 degrees to 30 degrees.

Manufacturers furnish special wrenches for setting the angle of the nozzles. The use of these wrenches is recommended, as it is extremely difficult to obtain a uniform spread with visually set nozzles. All nozzles should be set at the same angle except for the cut-off nozzle. (end nozzle) Manufacturers make a nozzle with 1/2 spray pattern for this purpose.

At the time the angle of the nozzles is set, the edges of the nozzle openings should be inspected to see that they are not damaged. A nicked or otherwise damaged edge will produce a distorted fan of asphalt.

Streaking Will Occur:

- If the asphalt is too cold.
- When the viscosity of the asphalt is too high.
- If the snivies are not at the same angle.
- When the bar is too high.
- When the bar is too low.
- When the bar pressure is too high it cuts furrows because the snivies are too small and/or there is too much pump pressure.
- When the bar varies in height from a full to an empty distributor, blocking or locking against the overload springs will reduce or eliminate this variance in height.
- When the bar is too long and/or the snivy openings are too large for the pump capacity, this results in narrow and fluttering fans. Smaller snivies and/or higher pump capacity will correct this.
- If the pump pressure is too low it will create narrower spray fans and fluttering.
- If the distributor tank is allowed to run completely empty, an irregular pattern of misses and fluttering will occur across the bar. For this reason, the shot should be terminated while approximately 100 gallons are left in the distributor.

Cleaning of Distributor

Cleaning of the distributor should take place in an area determined by its characteristics that are protective of the environment. For example: areas near waterways or with high seasonal water tables would not be necessarily suitable. These cleaning areas may require all fluids to flow through an oil water separator and all tank and bar cleaning agents to be barreled and labeled for disposal. No discharging or blowing your distributor bars in the ditch line, upon the right-of-ways or on private property is allowed, this could result in a serious violation.

Checking the Bitumeter

A bitumeter consists of a rubber-tired wheel, mounted on a retractable frame, with a cable leading to a circular dial in the cab of the vehicle. The dial registers the rate of travel in feet per minute and the total distance of each trip in feet. At least one manufacturer furnishes a dial that registers the application rate in gallons per square yard in addition to travel in feet per minute.

Check the bitumeter at regular intervals to ensure accurate registering of speeds when the distributor is spraying asphalt. To check the bitumeter, a distance of 500 feet to 1,000 feet is marked off accurately on a straight and level length of road. The distributor is driven at constant speed over this length and the trip is timed with a stopwatch. Then the speed in feet per minute is calculated and compared with the bitumeter dial reading recorded during the run. This procedure is repeated for a number of other speeds, bracketing the speed to be used for spraying.

Errors found at the various speeds are tabulated or plotted on a graph so they can be readily applied when using the distributor. The bitumeter when used must be kept clean to ensure accurate registering of the truck speed. A build-up of asphalt on the wheel will produce an error.

Traffic Control

Traffic control is important and must be maintained throughout the work area. High speed traffic over a fresh seal coat displaces aggregate, causing bleeding of asphalt. Traffic should be allowed only in the lane not being sealed. When work is completed, traffic speed should be maintained at less than 35 mph, or the legal speed if under 35 mph, until the asphalt sets. Warning signs, flag persons, and pilot cars are essential for traffic control. Route trucks hauling aggregate to the aggregate spreader in a direction opposite of the seal coat operation. This prevents loaded trucks being turned on freshly placed seal coat.

Some emulsions such as High Floats may require up to 24 hours of traffic control or until the first sweeping occurs. This is in areas of high volume traffic or areas where vehicle weight exceeds the normal load range.

Application of Asphalt

It is very important that the correct amount of asphalt be applied to the surface, as too much or too little asphalt will cause a slick roadway surface. If not enough asphalt is shot, the rock will ravel off leaving a surface rich in asphalt. If too much asphalt is shot, it will flush to the surface.

Many factors are used to determine the amount of asphalt to shoot, including the grade of asphalt, size of aggregate, condition of roadway surface, and traffic. After a rate of application is determined, a shot of asphalt should be put down, covered with aggregate, and rolled. A field check should be made by checking to see that the asphalt depth is approximately three-quarters of the way up on the firmly placed aggregate. Any adjustment needed should be made in the asphalt application rate at

this time. A field check should be performed periodically during the day to assure correct application rates are maintained throughout the entire project.

Rough and unsightly transverse joints can be avoided by starting and stopping the asphalt spread on building paper. The distributor, traveling at the correct speed for the desired application rate, starts spraying on the paper so that a full, uniform application of asphalt results when reaching the exposed surface. The use of smaller, more absorptive aggregate at the ends has been successfully used instead of paper.

A longitudinal joint is usually unavoidable because traffic lanes must be maintained. If possible, longitudinal joints should be made along the centerline or center of lane of the pavement and never in the wheel tracks. To prevent aggregate from building up on the longitudinal joint, the edge of the aggregate spread should coincide with the edge of the full thickness of applied asphalt. This allows a width where asphalt is present in partial thickness, due to outside nozzle spray, that can be overlapped when asphalt is applied in the adjacent lanes.

Spreading Aggregate

All aggregate required for the planned spread should be on hand before starting. It should be dampened if necessary, as described in the section on Material Selection. When the distributor moves forward to spray asphalt, the aggregate spreader should follow immediately behind it. The asphalt must be covered as soon as possible, otherwise the cooling of the asphalt will prevent good adhesion between asphalt and aggregate. It is important that the aggregate be spread uniformly and at the proper rate of one rock thickness. Marking the length that each truckload of aggregate should cover aids in controlling distribution.

Chip spreader Calibration

The following is a step-by-step procedure on how to calibrate your chip spreader and calculate the application rate.

1. Construct a one square yard shallow box or tarp, with shallow and narrow sides.
2. Place the box/tarp in the middle of the roadway a minimum of 50 feet in front of the chip spreader.
3. Get the chip spreader up to speed and apply chips over the top of the box/tarp.
4. Remove the box/tarp with the chips from the road.
5. Find an accurate materials scale. If in the field, the scale must be leveled and checked.
6. Place the chips from the box/tarp in a small bucket and weigh the bucket with the chips.
7. Empty the chips out and weigh the empty bucket.
8. Subtract the weight of the empty bucket from the weight of the bucket with the chips.

Patching and Pavement Repair

9. Since you had a one-square yard box/tarp, the weight from Step 8 is your pounds per square yard of chips.
10. Repeat the process at two to three gears and two to three RPM or speeds. You can then develop a chart.

NOTE: The aggregate weight may vary a couple of pounds if the chips are wet.

TONS OF AGGREGATE REQUIRED PER MILE FOR VARIOUS WIDTHS AND RATES

Spread Rate	Spread Width (in Feet)						
	8	9	10	12	16	18	20
lb/yd ²	Tons Per Mile	Tons Per Mile	Tons Per Mile	Tons Per Mile	Tons Per Mile	Tons Per Mile	Tons Per Mile
5	12	13	15	18	23	26	29
10	23	26	29	35	47	53	59
15	35	40	44	53	70	79	88
20	47	53	59	70	94	106	117
25	59	66	73	88	117	132	147
30	70	79	88	106	141	158	176
35	82	92	103	123	164	185	205
40	94	106	117	141	188	211	235
45	106	119	132	158	211	238	264
50	117	132	147	176	235	264	293
60	141	158	176	211	282	317	352
75	176	198	220	264	352	396	440
100	235	264	293	352	469	528	587
150	352	396	440	528	704	792	880
200	469	528	587	704	939	1056	1173
250	587	660	733	880	1173	1320	1467
300	704	792	880	1056	1408	1584	1760

<u>To convert from</u>	<u>to</u>	<u>Multiply by</u>
Feet	metres	0.3048
lb/yd ²	kg/m ²	0.542492
tons/mi	Mg/km	0.563698

Chip Spreader

Chip spreaders kick the aggregate backward or drop the aggregate straight down to reduce aggregate rollover and reduce the degree to which the aggregate picks up on vehicle tires after the section has been opened to traffic. The spreader is a variable width machine and calibrated on pounds per square yard. Dump trucks work in combination with the chip spreader to achieve a uniform application of aggregate.

Rolling

Rolling seats the aggregate in the asphalt and promotes the bond necessary to resist traffic stresses. Pneumatic tired rollers should be used on all seal coat jobs to give uniform ground pressure over the entire area to achieve proper embedment of the aggregate in the asphalt binder. Steel wheeled rollers tend to compact only high spots and can fracture soft aggregates.

Rolling should begin immediately after the aggregate has been distributed and should continue until the aggregate is properly seated in the binder. Rolling should begin at the outer edge of the treatment and proceed in a longitudinal direction, working toward the center of the road. Each trip should overlap the previous trip by about one-half the width of the front wheels. As soon as the asphalt has a definite set or hardening, rolling should be discontinued, to prevent the bond between the surface and aggregate from being broken by the roller.

Rollers should be operated at slow speeds (4 to 6 mph) to set the rock, not displace it. The number of rollers required for a seal coat project depends on the length of the operation. It takes two to four passes of the roller to set the rock. These rollers should have tire pressures of (45) psi or more.

Loose aggregate should be swept along the longitudinal joint and from the uncovered lane prior to application of asphalt. Brooming loose aggregate on a completed sealed surface should be done as soon as practicable, and during the cool part of the day, to minimize flying rock problems.

Relying on traffic to seat the aggregate has been successful, if speed is controlled, but using rollers gives better control and improves the chances for success.

Spreading of Fines or Choking - Optional

The need for applying fines will vary with the types of emulsions used and application rates. Those rates must be closely monitored. The most common material used for choking is 3/8" to #10 or 1/4" minus maintenance sand. In urban areas clean masonry sand can be used. Spreading these fines on a seal helps fill the voids, key the stone, reduces the chances of bleeding, and stops the squeezing and tracking of asphalt. The application of these fines prior to the roller, or after the roller depends on the types of emulsions used, and the location of the project. Fines application should not cover the coarse aggregate but merely fill the voids. The spreading of fines could be achieved by using a Hopper Sander with a mid mount spinner. This vehicle may be placed before or after the rollers depending on the type of operation.

Post-Seal Inspection

The embedment of the aggregate into the asphalt should be checked a day or so after the construction of the seal coat. Remove several of the largest stones and determine if the 50 percent to 70 percent embedment has been obtained.

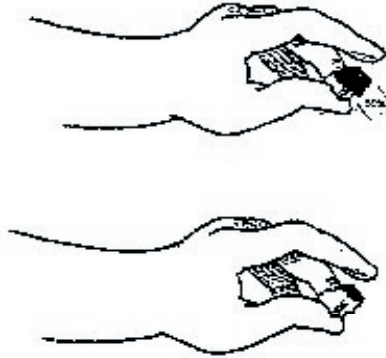

If an inadequate application of asphalt was applied, a fog seal can enrich and tie down the seal rock. A diluted CSS-1 (usually 50/50) is applied at the rate of .1 to .2 gallons per square yard of the dilution. (Application can vary depending on pavement texture, local conditions, and traffic). No cover aggregate is required; however, if a tighter seal is desired, a sand or 1/4" 0 cover may follow. Traffic should be controlled until the CSS-1 has cured.

DOs of Seal Coating

- Do turn spray nozzles so that fans are at proper angle to spray bar, so sprays do not touch or merge.
- Do check bar height at start of each shot to determine ground-to-nozzle distance over entire bar length.
- Do check spraying pressure so as to give constant uniform spray. Pressure too high will cause spray to fog and distort, pressure too low will cause spray to sag with heavy edges and pronounced longitudinal streaking.
- Do heat asphalt to upper part of spraying temperature range to eliminate heavy edge that is characteristic of all fan type sprays.
- Do keep spray bars in proper working order by regular cleaning and inspecting of strainers. Clean spray bars after each day's operation.
- Do keep aggregate stockpiles clean and free of contaminates.
- Do clean out tank thoroughly when changing asphalts from emulsified to cutback asphalts or from cationic to anionic emulsions.
- Do keep equipment on the same side of the roadway that the sealing operation is on, so traffic flow is not impeded.
- Do cover shot as soon as possible and roll immediately to ensure a good bond.

DO NOTs of Seal Coating

- Do not use worn nozzles or ones that have mechanical imperfections.
- Do not heat asphalt material above maximum temperature range, which would cause spray patterns of the fans to be uneven.
- Do not use asphalts that are too cold. Material will be too viscous and cause narrow spray fan, and materials will not flow together.
- Do not try to seal a wet or dirty road surface.
- Do not try to seal coat if air or road surface is too cold. Don't seal when windy.
- Do not make shots too long before applying aggregate.
- Do not turn equipment on a fresh patch.

Blade Mixed Asphalt Mix

Blade mixing of asphalt cold mixes is an economical and versatile method of producing material for construction or repair of highway pavement. High production rates are possible with a comparatively low expenditure, and entirely satisfactory pavements can be achieved with blade mixed cold asphalt. However, proper attention must be devoted to ensuring uniform quantities of aggregates, uniform aggregate gradation, and correct, uniformly applied quantities of asphalt are combined into the final mix design.

A wide variety of aggregates ranging from well graded crushed rock to silty sands can be mixed satisfactorily by cold blade methods. The optimum results will be obtained by using a uniformly graded manufactured aggregate with a maximum particle size of 1/2 inch or less and not more than 10 percent passing the No. 200 sieve.

Emulsified or cutback asphalts may be used in the production of cold mixes. Up to 3 percent surface moisture may be required on aggregates for successful mixing with emulsified asphalts and subsequent compacting of the mixture. The surface moisture of aggregates should be as low as possible if cutback asphalts are used.

Well graded mixes are made using an asphalt with a fairly slow rate of curing such as MC, SC, SS, or CSS. Open graded mixes are made with a faster curing asphalt such as MC or CMS, or RC if it is to be spread and compacted immediately. Asphalt cold mixes which are to be made and placed into stockpile for future use are made with an MC or SC asphalt of 250 or 800 grade.

Prior to beginning the mixing operation, a permanent base pad must be prepared at the site upon which the cold mix will be made. The pad should be reasonably level, 3 to 4 feet wider than the distributor spray bar, and must be surfaced with compacted hot or cold asphalt mix. The length of the pad can vary depending upon conditions but should be approximately 400 feet if possible.

The cold mix is made in batches, the size of which will depend upon the capacity of the distributor and the desired asphalt content. For a uniform manufactured aggregate of 1/2 inch to 0 inch gradation, with a desired asphalt content of 5 percent

and using a 1,000 gallon distributor, the batch size will be approximately 60 cubic yards.

Using a truck and tail gate or chip spreader, a layer of aggregate the width of the distributor spray bar is uniformly spread upon the length of the base pad at a rate of approximately 50 pounds per square yard. Heated asphalt is then shot over the layer of aggregate at a rate calibrated to yield the desired asphalt content. The amount of asphalt required will depend on the gradation of the aggregate and will normally range from 4 to 7 percent by weight of the completed mix. Successive layers of aggregate and shots of asphalt are placed one on top of the other until the batch is completed.

Mixing is accomplished by turning and blending the mixture with a grader. If several batches are being produced for stockpiling and production is a factor, the mixing is more efficiently accomplished by using two blades working in opposite directions. Well graded mixes will require a relatively greater mixing effort to coat all of the particles evenly than will be required for open graded mixes. Mixing should continue until a thoroughly uniform mixture is produced. The completed mix is then windrowed and picked up by a front-end loader and placed into stockpile.

Stockpiled mixes made with MC or SC cutback asphalts should be allowed to cure out for a period of time before the mix is used. Cure time varies depending on weather conditions but will normally be approximately two weeks.

Handling Emulsified Asphalts

- DO** when heating emulsified asphalt agitate it to eliminate or reduce skin formation. Agitation also prevents the asphalt lying next to the heating chamber from becoming overheated and boiling.
- DO** protect pumps, valves, and lines from freezing in winter. Drain pumps or fill them with anti-freeze according to the manufacturer's recommendations.
- DO** blow out lines and leave plugs open when they are not in service.
- DO** use pumps with proper clearances for handling emulsified asphalt. Tightly fitting pumps can cause binding and seizing.
- DO** use a mild heating method to apply heat to the pump packing or casing to free a seized pump. Discourage the use of propane torches.
- DO** warm the pump to about 150 F (65 C) to ease start-up.
- DO** when a pump is to be out of service for even a short period of time, fill it with No. 1 fuel oil to ensure a free start-up.
- DO** before diluting grades of emulsified asphalt, check the compatibility of the water with the emulsion by testing in a flask.
- DO** if possible, use warm water for diluting and always add the water slowly to the emulsion (not the emulsion to the water).
- DO** avoid repeated pumping and recycling, if possible, as the viscosity may drop and air may become entrained, causing the emulsion to be unstable.

- DO** guard against mixing different classes, types and grades of emulsified asphalt in storage tanks, transports, and distributors. For example, if cationic and anionic emulsified asphalts are mixed, the blend will break and separate into water and coagulated asphalt that will be difficult to remove. Because it is hard to determine visually the difference between various emulsified asphalts, always make a trial blend of the newly-delivered emulsion and the stored emulsion before pumping off. Check the trial blend for compatibility.
 - DO** place inlet pipes and return lines at the bottom of tanks to prevent foaming.
 - DO** pump from the bottom of the tank to minimize contamination from skinning that may have formed.
 - DO** remember that emulsions with the same grade designation can be very different chemically and in performance.
 - DO** haul emulsion in truck transports with baffle plates to prevent sloshing.
 - DO** mix by circulation, or otherwise emulsions that have been in prolonged storage may not be the proper consistency, as emulsions tend to separate when stored for extended periods.
-
- DO NOT** use tight-fitting pumps for pumping emulsified asphalt; they may “freeze”.
 - DO NOT** apply severe heat to pump packing glands or pump casings. The pump may be damaged and the asphalt may become even harder.
 - DO NOT** dilute rapid-setting grades of emulsified asphalt with water. Medium and slow setting grades may be diluted, but always add water slowly to the asphalt emulsion. Never add the asphalt emulsion to a tank of water when diluting.
 - DO NOT** recirculate emulsified asphalts for too many cycles. They tend to lose viscosity when subjected to pumping. Also, air bubbles may become entrained which would render the emulsion unstable.

NOTE: Reprinted from Asphalt Institute’s/Asphalt Emulsion Manufacturers Associations: A Basic Asphalt Emulsion Manual. Please refer to this manual for additional information.

General

Water, either liquid or frozen, is the greatest natural destructive element that affects state highways.

Controlling water on the right of way requires a drainage system that effectively responds to the immediate environment. A typical highway drainage system includes ditches of all types, gutters, drains, culverts, storm sewers, and other miscellaneous drainage structures.

The system is designed and constructed to collect and remove water from the highway right of way. It must be properly maintained to:

- Permit the maximum use of the roadway
- Prevent damage to the highway structure
- Protect natural resources
- Protect abutting property from physical damage.

Maintain and preserve drainage facilities as nearly as possible in the condition and at the capacity for which they were originally designed and constructed. Inspect the entire drainage system at least twice a year and correct deficiencies. Additional inspections may be required during heavy storms and periods of high runoff in order to determine the effectiveness of the system. Observe and record high water marks. Look for conditions that threaten damage to the drainage facility or the highway. Maintenance personnel must be continually alert to assure that all natural water course channels crossing the right of way remain open.

Drainage from Abutting Properties

Storm water is the only effluent allowed to be discharged upon the highway right of way. State law “RCW 47.44” allows persons and entities who have been issued utility franchises or permits to encroach on or cross highway right of way to install and maintain the item for which the permit was granted.

Population growth, urban sprawl, and numerous new regulations restrict how maintenance crews can maintain surface and subsurface drainage systems.

Regulations that may affect drainage maintenance:

- Endangered species act
- Storm water management
- Wetlands preservation
- Growth management
- Shorelines
- Irrigation limitations

It is important that the Department not allow abutting property owners to discharge water onto the highway right of way without obtaining a permit. Property owners may obtain permits by applying at the WSDOT Area or Region office. Drainage design engineers and maintenance staff review potential drainage impacts from the abutting property to the highway right of way. The property owner may be required to mitigate water quality and/or quantity impacts to obtain a permit.

Maintenance personnel who routinely patrol a roadway section must be trained in the basic knowledge of what types of direct drainage and sheet flow from abutting property may require a permit. These include new:

- Commercial developments such as shopping centers
- Subdivisions
- Industrial development
- Automobile wrecking yards
- Dairy and other intensive farming activities

Maintenance personnel should report land use changes they observe to their supervisor. The supervisor will forward this information to the appropriate reviewer.

Ditches and Gutters

Open ditches should be routinely checked and maintained to the line, grade, depth and cross section to which they were constructed. Where practical, non-standard ditches should be modified to produce a relatively flat, shallow ditch to enhance motorist safety.

Vegetation in ditches often helps prevent erosion and treats storm water. Remove vegetation only when flow is blocked or excess sediments have accumulated. Remove vegetation using “best management practices” that minimize erosion and sediment escape to water bodies.

Excessive erosion of drainage ditches must be controlled or repaired. Ditch linings of loose or grouted rock and concrete or other energy dissipation methods can control erosion. However, these linings need be checked frequently and repaired as necessary.

Keep ditches and gutters free of litter and debris. Repair all cracks and breaks as necessary.

Be especially careful when chemicals are used for brush and grass control in open ditches. Herbicides must be carefully controlled so as not to contaminate water or to transfer and concentrate chemicals in adjacent areas where environmental damage may result. Always follow product application instructions.

Be alert for diversion ditches on top of cut slopes that prevent slope erosion by intercepting surface drainage. Diversion ditches must be maintained to retain their diversion shape and capability.

Surplus material that results from ditch cleaning can often be used for widening. Material placed into the adjacent portions of the highway or disposal areas must not obstruct or impair other roadside drainage areas. Do not use material that may cause sedimentation problems to water bodies. Take care to avoid causing erosion problems or loose unstable fills. Don't use non-porous materials such as clay. They can become unstable when wet and trap water in the existing fill. If there is doubt about using such surplus material contact the Region Soils Engineer for assistance.

Don't blade ditch cleanings across roadway surfaces. Dirt and debris remaining on the pavement after ditch cleaning operations must be swept from the pavement.

Avoid undercutting the roadway back slope or in slope. Undercutting weakens the slope and will cause damaging slip-outs and other forms of slope erosion.

Rockfall Ditches and Slope Benches

Keep rock fall ditches and slope benches clean. Large amounts of slough or rock fall and other slide material that effectively block the ditch or bench should be removed as soon as possible after they occur.

Dry Wells

Dry wells accommodate the drainage flow in certain areas where:

- Natural outfalls for a drainage system were not available.
- Their use reduces the need for or size of downstream facilities.

These dry wells should be inspected periodically. Replace the drain rock if storm water no longer percolates into the soil.

Culverts

A culvert is a conduit or pipe used as an artificial channel under a roadway or embankment to maintain flow from a natural channel or drainage ditch. Inspect all culverts at least twice a year. Keep them clean and in good operating condition.

Changes in the up stream watershed due to logging, land development activities, farming practices, forest fires, etc., may increase water run off, sedimentation and debris. With these conditions more frequent inspections, particularly after periods of high runoff, are necessary to enable maintenance personnel to take corrective measures if damage has occurred. During storms and floods, critical areas need to be inspected and the culvert inlets kept clear.

Repair and replace badly worn or broken culverts to minimize the possibility of damage to the roadbed by water saturating the fill material.

Drainage

Culverts with 50 percent or more constriction should be flushed or otherwise cleaned to restore the culvert's original capacity. (Use BMP's to minimize fish impacts when doing this work). Some of the larger culverts in flowing streams are designed for construction below the stream bed, to accommodate fish life. In these cases, the culvert should also be cleared of obstructions that may be detrimental to the passage of fish.

Check culverts for scour around the inlet and outlet. Repair scoured areas with rip-rap or some other protection if necessary. In some cases standing water is desirable at the inlet end of the culvert to settle out sediment. Vegetation at culvert ends can be controlled by residual herbicides or mechanical means.

Controlled burning of vegetation at culvert ends is a feasible alternative at some locations. Whatever method of vegetation control utilized needs to be accompanied by erosion and sediment control features/practices.

Pavement markings that show the location of culverts should be renewed annually. These markings are critical for quickly locating culverts for both emergency and routine maintenance. Pavement markings of more permanent materials, such as thermoplastics, are encouraged.

Automatic Pumps

Automatic pumps, sumps, and pipes at underpass structures or draining depressed sections of highway must be kept in good operating condition at all times. Each installation must be inspected on a routine basis, at least once per week. Inspections should include the electrical, ventilation, greasing and drainage systems.

Under Drains

Under drains are often constructed in the sub-grade to intercept subsurface water from springs and seepage water from the surface or percolating from below. Control of this water is essential to ensure the stability of the sub-grade upon which the highway is constructed.

Inspect under drains on the same schedule as culverts. Keep their outlets open and clean. Choked under drains can be cleaned by high pressure flushing with water or flexible sewer rods. In cases where roots effectively block the drainage, the use of herbicides may be indicated. Whatever method of cleaning is used, consideration for erosion and sediment control is needed.

Storm Sewers

In many areas underground pipe systems are necessary to carry storm runoff normally handled by ditches. Storm sewers are often used in long, depressed highways or along curbed sections on city streets. Water carried by the system is generally collected through inlets, catch basins, or manholes and carried by pipe to an out fall on a natural waterway.

Clogged pipes can often be cleaned with high-pressure water jets. But, if tree roots or broken pipes are causing the clogging, more service will be required. Flexible rotary cutters will remove roots intruding into a pipe.

Broken pipes may be repaired by jacking an insert liner into the failed location. Otherwise, the failed pipe may have to be excavated and relayed to repair it. Whatever method of cleaning is selected, consideration for erosion and sediment control is needed. In no case can debris or sediment be allowed to enter a water body.

Manholes are generally used where there is a change in profile or alignment and also at strategic points in long, straight sections in order to provide access for cleaning the conduit.

Periodically inspect and clean inlets, catch basins, and manholes using a vacuum truck or manual cleaning methods. Conduct inspections during storms to ensure that the inlet grates are not becoming clogged with water-born debris. Schedule sweeping operations to help prevent the accumulation of leaves, paper, or other clogging debris.

When pavement is overlaid by contract or maintenance work crews be sure that the manhole covers are flush with the finished pavement elevations.

Bank Protection

Maintenance personnel must be continually alert to conditions that may cause scour, undermining, or washout of highway embankments or structures by storms, floods, or wave action.

Highways adjacent to water courses, drainage ways, and embankments throughout the state are protected in a variety of ways against damage due to high water. These include barbs, stone rip-rap, grouted rip-rap, pile revetments, retaining walls and cribs, rock and wire mesh (gabions), and vegetation.

These features must be inspected during storms or periods of high water, as well as at least once each spring or after major high water periods, and repairs made where required. Make repairs with materials similar to those in place. If possible take corrective measures to eliminate the direct cause of the damage.

Hydraulic permits may be necessary and protection measures for fish habitat are required.

When the need for significant additional bank protection around structures or embankments is indicated, the Area Superintendent is to be notified immediately and a determination made as to whether or not the protection materials will be placed by maintenance or construction forces.

Detention Ponds and Tanks

Designers are increasingly specifying the use of detention ponds and tanks that store water runoff and release it slowly through a controlled out fall or outlet. In this way the size of downstream pipes and culverts can be reduced, erosion is mitigated, and solids that settle out can be removed.

To function correctly the controlled out fall or outlet pipe must be free of debris. Accumulated settled materials must be removed on a schedule based on experience at each site. If oil separators are combined with these facilities, timely removal and proper disposal of oils is essential.

If inspection or cleaning necessitates working inside an underground detention tank, confined space procedures must be followed.

Oil Separators

Oil separators are being used increasingly by WSDOT in conjunction with catch basins, manholes, and other drainage structures. While they vary in design, all function in much the same manner by reducing the velocity of the water flow through the drainage structure and not allowing floating debris to be flushed through. This allows oils carried by the water to accumulate and be contained within the drainage structure.

Once contained, these oils must be periodically removed and properly disposed of to prevent their being released back into the flow of the drainage system.

Generally, the same conditions that determine the schedule of inspection and cleaning required for standard catch basins and manholes also applies to units with oil separators. Oil separators, however, increase the rate of silt buildup within any drainage structure in which they are installed. Therefore, oil separators may require more frequent inspection and cleaning. Experience can best determine what schedule of inspection and cleaning is required to maintain these units in proper working order.

The Maintenance Accountability Process “MAP” sets the level of service for performing drainage maintenance.

General

The proper care of structures is vital to the preservation of the highway network and to the safety of the traveling public. This chapter discusses those items in which area maintenance personnel assist in this maintenance effort. Other more comprehensive references are available to the Maintenance Engineer.

For general responsibilities refer to the Transportation Structures Preservation Manual, M 23-11. For specific responsibilities for movable bridges, refer to the specific Operation, Inspection, and Maintenance Manual (OIM).

Major Structures

For maintenance purposes, major structures are identified as those bridges included in the Bridge List (M 23-09). The State Bridge and Structures Engineer is the responsible authority for these structures and must be contacted prior to any major maintenance or modifications to them. The designated contact in Olympia is the Bridge Preservation Engineer.

Bridges and other transportation structures closed due to structural damage, require approval from the Bridge Preservation Engineer before opening.

Minor Structures

For maintenance purposes, minor structures are identified as those drainage structures (culverts, etc.), retaining walls, acoustical barriers, cribbing, etc., that are not listed in the Bridge List. The Region Maintenance Engineer is the responsible authority for minor structures.

Any defects or damage to minor structures should be referred to the Area Maintenance Superintendent, who will coordinate the required action.

The structural components of sign bridges, bridge-mounted sign brackets, and high-mast luminaries are inspected and inventoried by the bridge preservation office. Major maintenance or modifications to these structures is to be coordinated through the Bridge Preservation Office. The designated contact in Olympia is the Bridge Preservation Engineer.

Inspection

Federal regulations require that all major highway structures be inspected by a crew under the supervision of a professional engineer, at intervals not exceeding two years. This requirement is met by the WSDOT Headquarters' Bridge Preservation Engineer and staff. Certain bridges, such as steel bridges, untreated timber bridges, bridges having a posted load limit, movable bridges, floating structures and bridges with pending repairs are inspected annually.

A bridge's condition can change in much less than two years. The Bridge Preservation Office relies on Region maintenance personnel to be alert for settlement, washout, collision damage, and other problems, and to notify their superintendent as appropriate.

Area maintenance crews are also expected to maintain or repair minor approach settlements, approach guardrail damage, plugged bridge drains, sweeping of bridge decks, asphalt overlays and other items that are considered part of normal maintenance operations.

Additionally, removal of dirt and debris accumulation on timber caps, timber stringers, steel expansion devices (bearings), lower chords of steel bridges and sign bridge bases are considered routine maintenance activity. However, at times these can become critical to a structure and will be added to the repair list.

Modifications to bridges need to be detailed in drawings and submitted to the Bridge Preservation Engineer for as-built documentation and future reference. All bridge structural as-built information is maintained at the Bridge Preservation Office.

All minor structures, related to bridges, should be inspected at least annually by the designated region maintenance supervisors or crews. Inspect more often if warranted by weather conditions or past experience.

The Bridge Preservation Office distributes a list of scour critical bridges to each region Bridge Maintenance office. These bridges are to be closely monitored during high water events. Scour critical bridges require close monitoring due to a high susceptibility to foundation damage caused by high water events. Area Maintenance Superintendents are responsible for monitoring weather conditions in anticipating high water events for scour critical bridges in planning for advance deployment of crews to monitor each bridge's condition. Scour is the number one cause of bridge failures in Washington.

Region bridge maintenance personnel are responsible to inspect all bridges and designated minor structures annually. Record all deficiencies. Keep the records on file until the deficiencies are corrected.

Review bridge inspection report notes, repairs, and photos to identify items to focus on during inspections.

During inspection, the following items should be checked. Deficiencies should be immediately repaired or scheduled for future work.

Approach Fills. Note any deficiency. Pay particular attention to the pavement seats of the structure. Look for sagging, pot holing, scaling, or spalling.

Asphalt Wearing Surface. Note potholes, scaling, wheel rutting, and general pavement condition.

Concrete Deck. Note scaling, spalling, cracks, and any exposed reinforcing steel.

Grid Decks. Look for and note broken welds or clips, loss of a section due to rust and any bent members.

Curbs and Railings. Note any deterioration, cracking, spalling, or damage.

Paint. Note the general condition of the paint. Look for cracking, peeling, fading, and presence of rust or algae.

Stringers, Caps, and Floor Beams. Note any crushing at bearing points, and any warping, cracking or debris buildup.

Steel Truss Members. Note bent or damaged steel, deflection, cracking, vibration, debris buildup on chord members, and deterioration due to rust. Pay particular attention to pinned joints at hinges, excessive rust, vibration, missing nuts, or loose plates. Immediately inform the designated bridge maintenance representative of any known or suspected problems.

Wood Truss Members. Look for and note damaged or broken members, crushing, cracking, warping, vibration, and deterioration due to rot or boring insects.

Expansion Joints. Note loose, banging, and jammed expansion joints. Also, note the presence and condition of the joint material.

Abutments, Bulkheads, Piers, and Intermediate Bents. Note any type of tilting, bulging, and deterioration. Pay particular attention to the buildup of drift debris and any scouring or undermining due to high water and erosion.

Bridge Drains. Note plugged bridge drains. Check pipe outfall areas to see if soil erosion is occurring. Plugged drains may result in saturation of the bridge approach fills and may explain any unusual erosion or undermining of abutments or bulkheads.

Waterways. Note scour and conditions that could cause log jams or ice jams during high water stages. Look for any logs or other debris jammed against piers, bulkheads, or piling. In the winter check all bridges with piers or bulkheads in the water with a floating debris problem during and after each flooding condition.

General Conditions. Look for accumulation of dirt, excessive bird droppings or debris on the roadway at bearing points and on the caps or lower chords. Pay particular attention to the presence of materials that might pose a fire hazard or

restrict access for maintenance activities. Note any unauthorized attachments such as private fences. Have electrical fences removed from bridge access areas or clearly mark them with warning signs.

Walls and Cribbing. Inspection can be of a cursory nature according to guidelines designated by the Area Maintenance Superintendent. Check walls for tipping, bulging, cracking, spalling, and water runoff over or through wall. Check all weep holes to assure that they are open. If the structure is wooden, check for rot and the presence of fire hazards.

Tunnels. Condition of walls, ceiling, or liner. Look for cracking, spalling or loose overhead hazards. Note increased water seepage, and the condition of wire retention fabrics. Check for tears or failures that may indicate potential structural hazards and impact on portals or overhead members.

Bridge Repair Guidelines

Any major or structural repairs need to be coordinated through and approved by the WSDOT Headquarters Bridge Preservation Engineer. If there is any doubt about the structural significance of a damaged or deteriorated bridge component, notify the WSDOT Headquarters Bridge Preservation Engineer. Generally, bridge repairs are identified on the bridge repair list.

There are six priority definitions in the repair lists. “Emergency” or “Urgent” priorities are intended to recognize the various levels of work accomplished by Bridge Maintenance. As maintained previously, these six repair priorities represent a priority level hierarchy; therefore, repairs that are not completed in a timely manner may be moved to a higher priority. Only four priorities will be published on the repair list since “Emergency” and “Urgent” repair lifecycles will be anticipated to be much shorter than the repair list publication cycle. They will be tracked in the Bridge Preservation Office repair database.

The use of “Emergency” and “Urgent” priorities will be authorized by the Bridge Preservation Engineer. These types of repairs will be reported directly to each region.

The priority definitions are as follows:

- **Emergency** – Repair work requiring immediate action when structures are partially or completely closed.
- **Urgent** – Repair work requiring prompt action that must be completed when structural details and bridge crews become available.
- **Priority 1** – Repair work required when damage to primary structural elements directly affects safety, reliability of transportation system, protecting public investment, and maintaining legal mandates. Secondary and minor items will qualify for this priority if they pose a hazard to traffic.

- **Priority 2** - Work should be accomplished within regular work schedule or programmed in the biennial work schedule.
- **Priority 3** - Generally a minor nonstructural or ‘housekeeping’ type of repair, which may evolve into a higher priority if not corrected.
- **Priority 4** - A condition that requires the structure to be monitored primarily by the bridge inspection teams, and may evolve into a higher priority.

The WSDOT Headquarters Movable Bridge Engineer prepares and updates individual maintenance manuals for all movable bridges. Consult these manuals for both routine and specialized maintenance tasks. Direct any questions to the Movable Bridge Engineer in the Bridge and Structures Office in Olympia.

Minor repairs to railings, curbs, concrete decks, expansion joints, etc., can be performed without the individual approval of the WSDOT Headquarters Bridge and Structures Office. Similarly, drift may be removed, clearance lights changed, etc.

Bridge Information

Bridge information is available to all DOT staff through the Bridge Engineering Information System—BEIST. Go to the Bridge and Structures website for a link to BEIST.

BEIST contains inventory data, bridge plans, inspection reports, the repair list, and related files. Additionally, BEIST contains the Sign Bridge Repair List and Standard Plans.

Environmental Aspects

WSDOT environmental staff will provide Maintenance Engineers, Area Superintendents and Maintenance Supervisors with training and education on which regulations apply to specific maintenance activities and what is the appropriate response to the regulatory process.

In addition to federal regulations, state environmental agencies, tribes and city or county health ordinances may have environmental restrictions on work done on or near bridges.

Before initiating bridge repair activities, the Maintenance Engineer, Superintendent, or Supervisor will confirm if environmental permits are required. They will also review the proposed repair method with the environmental staff to determine whether it is both appropriate and/or environmentally sound. The following list provides some of the environmental concern factors that impact bridge maintenance in some localities. This list is not comprehensive or current because the list of environmental factors to be considered continues to change. However, it does provide some insight into the degree to which maintenance is being held to an increasing level of environmental accountability.

- State or federal list of threatened or endangered species
- Species of high interest to state or federal agencies

Maintenance of Structures

- Migratory waterfowl habitat
- Anadromous fish habitat
- Trout and other cold water fish habitat
- Habitat for birds of prey (Must have Bridge and Structures approval to attach platform, boxes or any other structure to any part of a bridge).
- Wetlands and wetland habitat
- Riparian habitat
- Migratory corridors
- Wintering areas and other critical feeding areas of wildlife
- Important wildlife reproductive habitat
- Public water supplies, including important aquifers
- Islands and other coastal barriers
- Hazardous waste
- Regulatory flood ways and other flood plain areas
- Commercial fish and shellfish production areas
- Important sport fishing areas
- Highly erosional soils
- Listed or proposed wild and scenic rivers
- Navigable waterways
- Significant historic resources
- Natural resource agency holdings or interests (refuges, parks, habitat areas, etc.)

The Bridge and Structures Office is concerned with the placement of temporary or permanent wildlife habitat structures (peregrine falcon platforms, bat boxes, etc.) on state bridges due to their potential negative impact to inspections of all bridges in accordance with the federally-mandated National Bridge Inspection Standards and the potential negative affects to maintain the bridge structure itself. The Bridge and Structures Office discourages the practice of placing these habitat structures on state bridges.

Therefore, all plans to place temporary or permanent wildlife habitat structures on state bridges are to be reviewed by the Bridge Preservation Engineer. This is consistent with the review process for all other attachments to bridges.

Maintenance agreements established with any regulatory agency that includes bridges must have approval from the Bridge and Structures Office. Agreements that define or limit access to a bridge due to the Endangered Species Act, affect inspections and repairs.

Utility Installations

Bridge Maintenance Superintendents need to work directly with region utility engineers to coordinate utility installations to ensure construction inspectors are aware of the utility installation and inspect the construction for proper installation per the franchise agreement and structural details approved by the Bridge and Structures Office. Scaffolding attached to or setting on any portion of the bridge is to be included in the review by the bridge office.

Construction inspectors are to ensure that the utility contractor is following DOT-prescribed construction practice in accordance with WSDOT Standard Specifications.

General

This chapter addresses roadside maintenance issues primarily as they relate to vegetation management. It also covers maintenance in relation to litter control and auxiliary features such as Safety Rest Areas, viewpoints and historical markers. Roadside issues as they relate to areas of maintenance such as drainage, pavement and maintenance of structures, are covered in other chapters of the Maintenance Manual.

This chapter has been written to integrate with information relating to roadside management topics presented in all other Departmental documents. In particular it is tied to the contents of the **Roadside Manual**, the **Roadside Classification Plan** and the **Design Manual**. Roadside maintenance managers should be familiar with the contents of these other documents as they relate to roadside maintenance.

Definitions

Roadside: The roadside is the area outside the traveled roadway. This applies to all lands managed by WSDOT and may extend to elements outside the right of way boundaries. It includes unpaved median strips and auxiliary facilities such as rest areas, roadside parks, viewpoints, heritage markers, pedestrian and bicycle facilities, wetlands and their associated buffer areas, stormwater treatment facilities, park and ride lots, and quarries and pit sites within the Right of Way.

Roadside Management encompasses the planning, design, construction and maintenance of the roadside.

Its goals include:

- Provide for all the highway functional and operational objectives
- Protect the environment
- Create and/or maintain desirable visual quality

These goals can be achieved with the lowest life cycle costs by:

- Applying consistent, long term strategies throughout the management process
- Using appropriate site specific best management practices (BMPs)
- Using appropriate Integrated Vegetation Management (IVM) techniques

Integrated Vegetation Management: Integrated vegetation management (IVM) is defined as a coordinated decision making process that uses the most appropriate vegetation management strategy on a site specific basis. It utilizes a monitoring and evaluation system to ensure achievement of roadside maintenance program goals and objectives. IVM practices are environmentally responsible and economically sound. WSDOT uses IVM to design and construct roadsides which will grow and evolve with the natural ecosystem. The type of site specific vegetation chosen is designed to require the least possible attention from maintenance over the long term.

Best Management Practices (BMPs): They are physical, structural, and/or managerial practices that, when used singly or in combination, reduce the downstream quality and quantity impacts of stormwater.¹ Typical BMP's include biofiltration swales, wet ponds vegetated filter strips, and wet vault/tanks. BMP details can be found in the "Highway Runoff Manual" Chapter #8.

Reference

Roadside Manual, WSDOT, M 25-30
Roadside Classification Plan, WSDOT, 1996
Integrated Vegetation Management for Roadsides, WSDOT, July 1997
WSDOT Maintenance Manual for Water Quality and Habitat Protection Guidance, WSDOT, IL 4020.00, July 1, 1999
Highway Runoff Manual, Chapter #8, WSDOT, M 31-16
Design Manual, Chapters #12 & 13
Maintenance Accountability Process Handbook

Resources

Headquarters Maintenance Office
Region Landscape Architects
Headquarters Roadside and Site Development Office
Regional Environmental Offices

¹ *Highway Runoff Manual*, M 31-16. WSDOT, pp Glossary 1-2

Roadside Functions

The roadside is managed to fulfill four functional categories: **operational, environmental, visual, and auxiliary functions**. By fulfilling highway needs in these four categories, the roadside contributes to WSDOT's delivery of transportation services. Table 7.01 explains the functions and gives examples.

Function	Examples
Operational	Those functions that provide safe and multi-use roadsides. Operational functions include access control, providing vehicle recovery areas and sight distances with accommodations for signs and utilities, and snow storage. The Design Manual provides the primary guidance for operational roadside design guidance.
Environmental	Those functions that protect and enhance our natural and built surroundings. Environmental functions mitigate the roadway's impact on its surrounding ecosystem. Major environmental functions include: <ul style="list-style-type: none"> • Water quality (preservation, protection and improvement) • Storm water detention and retention • Wetland and sensitive area protection • Noxious weed control • Noise control • Habitat protection and connectivity • Air quality improvement • Erosion control
Visual	Those functions that are designed and experienced primarily from a visual perspective. Visual functions promote a positive quality of life and are integral to operational, environmental, and auxiliary functions. They include enhancing guidance and navigation, distraction screening, corridor continuity, roadway and adjacent property buffering, and scenic view preservation. There are two primary roadside views: Those from the roadway, and those toward the roadway. In addition many activities such as noxious weed control, wetland and sensitive area preservation, and habitat preservation are readily perceived and evaluated through sight.
Auxiliary	Those functions that provide additional operational, environmental, and visual functions to support or supplement the transportation system. Examples of auxiliary facilities are community enhancement areas, safety rest areas, roadside parks, viewpoints, agricultural uses, heritage markers, bicycle and pedestrian facilities, park and ride lots, and stockpile sites.

Table 7.01

Roadside Treatment

The **Roadside Classification Plan** (RCP) provides the basis for solutions to site specific questions on how to develop and manage the roadside. This document provides guidance for resolving the roadside functional needs with variations in site conditions, vegetative patterns and geographic surroundings.

Maintenance Involvement in the Roadside Management Process

Maintenance plays the major role in the roadside management process. The overall goal of roadside maintenance is to sustain the roadside in a manner that satisfies the intent of the RCP and performs as many functions as possible, while requiring the least amount of care.

Roadside maintenance is a unique element within the highway maintenance program because much of the work involves caring for and/or controlling vegetation. Roadside plant communities are alive and part of a dynamic, ever evolving natural process. Therefore, proper maintenance of the roadside requires understanding of the many factors which contribute to the natural evolution of vegetation over time.

It is in the best interest of Design and Construction organizations to solicit input from the maintenance crews during the process of Planning, Designing and Constructing roadside features. Maintenance personnel should also take the initiative to provide documented input for consideration during this process.

It is vital that local maintenance employees be involved in the regional project development process as it relates to the roadside. The project delivery process within each region will vary. But, before a contract is finalized the project must be thoroughly reviewed by the local maintenance personnel with responsibility to care for the highway and roadside effected. Maintenance personnel can also offer valuable input during construction.

It is in the role of Design and Construction to continuously solicit Maintenance input on the processes of building, preserving and/or improving the highway. Maintenance personnel must take the initiative in offering appropriately documented input for consideration throughout the process of planning, design and construction.

Roadside Maintenance and the Maintenance Accountability Process

The **Maintenance Accountability Process** (MAP) is used by WSDOT to explain the relationship between maintenance service levels and the resources required to deliver those levels. The MAP is a comprehensive management program that provides a clear link between maintenance goals, activities, service levels, the budget, and maintenance performance measures.

The major elements of roadside maintenance are referred to in the MAP as Group 3 - Roadside and Landscape Maintenance. The MAP defines Roadside Maintenance as having five major activities:

- Litter Pickup
- Noxious Weed Control
- Nuisance Vegetation Control
- Control of Vegetation Obstructions
- Landscape Maintenance

These elements serve as “service level” or outcome indicators, and are intended to measure how well the roadside is fulfilling the major functional needs of the highway. All MAP activities are field measured on a regular basis to determine service levels statewide as well as at the regional and maintenance area level.

One of the most valuable features of the MAP for roadside maintenance is its provision of consistent statewide outcomes for roadside maintenance decisions. These service level commitments serve as a basis for setting roadside maintenance action thresholds and help the areas plan roadside activities.

A unique result of applying an outcome based management system to the vegetation management process is the ability to measure results. It’s possible to demonstrate an increasing service level over time, without an increase in funding.

Roadside vegetation, if managed properly, can become more naturally self-sustaining over time and require less control from maintenance as it grows and matures. With IVM, the overall service levels for Group 3 will improve over time under the following conditions:

- Consistent adequate resources to use BMP’s
- Ability to apply properly timed target specific roadside maintenance treatments

Roadside Management Zones

To address the highway’s functional needs (as describe above), the roadside may be divided into as many as three major bands of area referred to as Zone 1-Vegetation Free, Zone 2- Operational, and Zone 3 - Transition/Buffer. Roadside maintenance priorities within these zones are established beginning with activities relating to the safe highway operations and maintenance, and preservation of the highway roadway.

Most “high priority” and routine roadside maintenance activities occur in Zones 1 and 2. They are designed and maintained to facilitate operational roadway functions such as: surface and subsurface drainage, traffic operations visibility and site distance. Zones 1 and 2 also allow unobstructed vehicle recovery where traffic may accidentally leave the roadway (referred to as the **Design Clear Zone**). The Design Manual, Chapter 650 provides guidance on the required extent of the roadside “clear zone” (Zone 2) for varying highway configurations. In some cases the actual requirements for the clear zone, may extend beyond the right of way lines.

Zone 3 is present where adequate right of way area exists beyond what is necessary to deliver operational functions of the highway. Zone 3 is managed to address some safety functions such as hazard trees and trees shading the roadway. There are other operational functions which may be addressed within the area of Zone 3 such as drainage, noise and visual attenuation, and stormwater management needs. However, Zone 3 is primarily developed and maintained to address the visual, auxiliary, and non-regulated environmental functional needs of the highway. Zone 3 offers the greatest opportunity to create and maintain self-sustaining, low maintenance plant communities.

Roadside maintenance program objectives are established and prioritized to deliver the functional needs of the highway within the three zones.

Figure 7.01 shows a cross-section of a typical divided highway, illustrating typical relationships of the Roadside Management Zones within the highway right of way and giving examples of the functional objectives as they apply to the three zones.

Typical Roadside Management Zones

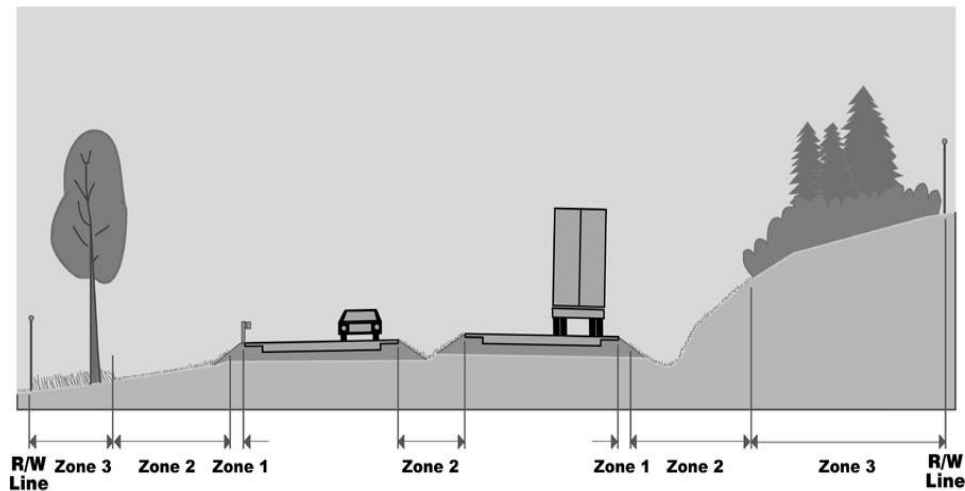

Functional Zone Objectives

Zone 1 – Vegetation Free	Zone 2 – Operational	Zone 3 – Transition/ Buffer
(0 to 2 feet from pavement or as necessary)	(From Zone 1 or pavement edge to meet operational and maintenance needs)	(From Zone 2 to Right of Way line)
<ul style="list-style-type: none"> • Provide for surface drainage • Reduce fire potential • Provide for visibility and maintenance of roadside hardware • Prevent pavement breakup by invasive plants • Provide sight distance for passing, stopping and at intersections • Prevent the buildup of wind blown debris and winter sand at the pavement edge 	<ul style="list-style-type: none"> • Maintain design width for vehicle recovery • Provide sight distance for passing, stopping, at interchanges and at intersections • Maintain hydraulic capacity of ditches • Eliminate vegetative obstructions (trees with a trunk diameter of 4" or more) • Control weeds • Prevent erosion • Provide wildlife habitat where compatible with roadway traffic • Accommodate underground utilities • Enhance visual quality 	<ul style="list-style-type: none"> • Promote self-sustaining plant communities • Blend and/or screen adjacent surroundings to meet the goals and objectives of the Roadside Classification Plan • Eliminate hazard trees causing excessive shade (ice and frost potential) on the highway pavement • Control weeds • Prevent erosion • Maintain and enhance visual quality • Preserve wetlands and wildlife habitat • Accommodate utilities • Preserve and conserve native plants and wildflowers

Figure 7.01

Maintenance of Zone 1

Policy

Zone 1 is maintained to remain free of vegetation. This zone begins at the edge of the pavement and extends outward to Zone 2. Zone 1 is no wider than necessary to achieve the functional objectives.

The optimum maximum width is 2 ft. or to the back side of roadside hardware (guide posts guardrail) if present. Variations in this width may be justified based on the following considerations.

Areas where Zone 1 requirements are less than 2 ft. or unnecessary:

- Roadsides and medians that have adequate profile and ditch to provide surface runoff
- Required by environmental commitment
- Immediately adjacent to flowing or standing water
- Abutting curb and sidewalk sections
- Turf grass areas in rest areas and formal landscapes
- Adjacent to full depth pavement (Where shoulder pavement functions as Zone 1).
- By agreement/permit where maintenance is done by others

Areas where Zone 1 may be wider than 2 ft.:

- Where visibility and maintenance of highway hardware such as guardrail or fencing must be facilitated
- Where there is a high risk of fire
- Natural rock and gravel ditches where it is impractical to maintain desirable vegetation
- Narrow areas adjacent to formal shrub beds
- Where farming activities take place very close to the roadway shoulder and it's impractical to maintain a strip of grass
- Where drifting sand or snow may accumulate on the roadway as a result of vegetation growth at the edge of the pavement
- For sight visibility at selected intersections or approaches when mowing is not practical

Methods

Because Zone 1 is maintained to be free of vegetation, it requires more regular and routine maintenance attention than any other zone. The primary tools available to accomplish this are non-selective herbicide products which bind within the soil profile and suppress seed germination throughout the growing season. Non-selective herbicides which eliminate existing living plant material through contact with the leaves or stem may also be used to control emergent vegetation in this zone. But, the use of these non-selective post-emergent products alone may require more than one treatment during a single growing season. Labor time intensive non-herbicide controls are available for special situations.

Maintenance of Zone 2

Policy

Zone 2 is maintained to fulfill the safety and operational functions of the highway roadside. However, maintenance of this zone also has a significant impact on the visual functions, due to human perceptions of roadside neatness and degree of care. Negative visual impacts such as (brown outs) from herbicide applications should be avoided whenever possible.

Zone 2 when present begins at the edge of the pavement or the outside edge of Zone 1. It extends outward to the right of way line or the edge of Zone 3 (where present). The optimum minimum width is determined by the clear zone vehicle recovery criteria which is given in the Design Manual, Chapter 650 and the site distance criteria given in the Design Manual, Chapters 800, 910, 920, and 1020. Roadside clear zone requirements may be eliminated, when appropriate, with the installation of guardrail or concrete barrier.

Variations from the optimum minimum width may be justified based on the following:

Areas where Zone 2 may be less than the minimum width specified in the Design Manual:

- Where compromises exist on older highways and adequate widths were not established during previous construction and Maintenance funding levels do not provide for improvement.

Areas where Zone 2 may be wider than the minimum width specified in the Design Manual:

- Where the edge between Zone 2 and 3 has been set through the Design and Construction process and Maintenance has adequate resources to sustain Zone 2 beyond the minimum required width.
- Where the outside edge of Zone 2 was not established through Design and Construction, but the Roadside Classification Plan allows for and Maintenance has adequate resources to accomplish Nuisance Vegetation Control beyond the required minimum width.
- Where visual access is desirable across the right of way either from the road out or from lands adjacent to the right of way.

Methods

Most maintenance activities applied in Zone 2 are intended to keep vegetation from encroaching on the highway's safety and operational functions. The maintenance focus in Zone 2 is to selectively cut back or remove vegetation which impacts these functions. Selective methods should be used whenever possible to control unwanted vegetation. An example is using a broad leaf controlling herbicide to remove noxious weeds or nuisance vegetation from a grass stand. Other methods may be non-selective, such as mowing of a grass stand as needed to prevent undesirable vegetation from maturing or setting seed.

Maintenance work in Zone 2 presents some of the most visible evidence of roadside management. Methods selected may have a significant impact (positive or negative) on visual quality. The MAP does not directly measure visual quality as part of the service level for roadsides. However, visual quality is important to the traveling public who perceive this as an indication of the overall maintenance service level.

Legislative service level commitments and funding levels often do not allow for consideration of the visual impact from Zone 2 maintenance. Plan the timing of herbicide applications for tree and brush control in Zone 2 to minimize “brown-outs”. Avoid the use of flail or rotary type side arm mowers for side trimming of native vegetation whenever possible.

Maintenance of Zone 3

Policy

Zone 3 exists only when there is adequate right of way beyond the requirements for Zone 2. It is managed to be self sustaining to the greatest degree possible, naturally evolving over time to blend with the surrounding vegetation and compliment the human built environment.

Zone 3 begins at the outside edge of Zone 2, or behind guardrail or concrete barrier. It extends to the right of way boundaries on the outside shoulder, or an opposing edge of Zone 2 such as in a wide median strip or the interior of an interchange configuration. Zone 3 may also include a managed strip along the outside edge of the right of way managed to allow for maintenance access if needed.

Methods

If Zone 3 has been properly designed and developed, very little attention from Maintenance normally is required. Zone 3 maintenance activities are selective whenever possible. Examples of selective maintenance treatment include the removal of noxious or nuisance weeds, hazard trees, or the thinning of trees in areas where shading increases the likelihood of frost or ice on the roadway. Some pruning of trees may be required. The majority of this work must be done by hand. Chippers may be used to dispose waste material on site. Trees should be dropped in place and left to decompose within zone 3 whenever possible.

Preserve desirable vegetation when nuisance vegetation such as Himalayan blackberry or Scotch broom is removed from Zone 3.

Integrated Vegetation Management

Integrated Vegetation Management is a coordinated decision making process that uses the most appropriate vegetation management methods and strategy, along with a monitoring and evaluation system, to achieve roadside maintenance goals and objectives in an environmentally and economically sound manner.

The majority of roadside management work is focused on the control of undesirable vegetation. This goes hand in hand with the establishment of and care for desirable vegetation. To accomplish this, WSDOT is required under RCW 17.15 to utilize Integrated Pest Management (IPM) principles.

WSDOT has defined IPM methodology as it applies to roadside vegetation management in the document **Integrated Vegetation Management for Roadside, July 1997** and uses the term Integrated Vegetation Management (IVM) as synonymous with IPM. An IVM approach can be applied beginning at any point throughout the roadside management process.

Methods

The four basic groups of methods employed to manage vegetation are: biological, chemical, cultural and mechanical. Use of the most effective method, or combination of methods within an IVM decision-making framework as described above will result in the highest roadside service levels at the lowest life-cycle costs.

- **Biological** - Methods which use living organisms to inhibit a host plant's ability to survive or reproduce are considered biological controls. Insects, diseases, and foraging animals such as deer and cattle are examples of biological control organisms. Biological methods are typically applied only when weed infestations are so well established that total eradication is not practical or possible. Predators are dependent on the presence of host plants for survival. Careful testing and screening must be applied prior to releasing biological control organisms to ensure they will not also attack native or other desirable plants.
- **Chemical** - The use of herbicides to control weeds and undesirable vegetation, the use of plant growth regulators to reduce pruning or mowing requirements and the use of insecticides to control predatory insects of desirable plants are examples of chemical control methods. There are a wide variety of chemical control products available for vegetation management. Chemical methods can be somewhat controversial due to the potential impact of certain products on human health and the environment. Extra care must be taken when utilizing chemical controls to address public sensitivity to these tools and to minimize potentially adverse impacts.
- **Cultural** - Techniques which benefit the development and/or health of desirable, competitive plant material are considered cultural methods. Cultural methods also include the planting or seeding of desirable species. Planting and establishing the right of way in compliance with the Roadside Classification Plan, through project design and construction are cultural control techniques.
- **Mechanical** - Methods which use equipment to mow, cut, prune, or cultivate in a manner which reduces, removes or prevents undesirable plant growth. Mowing Zone 2 to remove seedling trees and undesirable brush from a grass stand is an example of mechanical vegetation management.

There are many factors to consider when planning for and implementing an IVM program. These include prioritizing needs, and selecting the proper tools and strategies. Roadside maintenance priorities and Best Management Practices (BMPs) must be developed by the local maintenance crews for their geographic area. Priorities will be specific to the areas unique set of roadside configurations and based on service level commitments in the MAP. It is important for maintenance employees to utilize the many information resources and personnel with roadside expertise within the agency when planning for and carrying out roadside maintenance in their area.

Specific factors to consider when planning for and applying vegetation management techniques include the following:

Noxious Weed Control

Noxious weed species and the processes for regulation and control are defined in RCW 17.10. All state agencies are required to control noxious weeds on lands they own.

Noxious weed control is important because new infestations often appear first along highway corridors. Management of the right of way, because of its linear nature, can impact an enormous number of neighbors. WSDOT must be a responsible steward of state owned land. It supports commerce and the economic viability of the agricultural community. The agency also values environmental preservation. To meet responsibilities it is necessary that noxious weeds be controlled. State law requires the control of certain weed species within highway rights of way. Activities required for control have to be given priority over all other vegetation management activities except those that directly and immediately affect the safety of the public.

Sometimes Maintenance resources do not allow for full control of all noxious weed infestations within a given year. In these situations the area Maintenance Superintendent and the local county weed board will need to negotiate a multi-year strategy for regaining control.

When prioritizing control efforts apply the following guidelines:

First Priority

Control all Class “A” noxious weed infestations and those weeds on the Class “B” list as designated by each individual county weed board or district to an acceptable level. The highest priority is for new infestations and established weed populations where adjacent neighbors are making an effort to comply with noxious weed regulations.

Second Priority

Areas where WSDOT has controlled noxious weeds in the past which are adjacent to neighbors that are not making an effort to comply with noxious weed regulations.

Work cooperatively with local weed boards and districts to achieve compliance on the adjacent lands where possible by:

1. Sharing information on new infestations with weed boards
2. Advising weed boards of adjacent lands that are not in compliance
3. Requesting from the weed boards that appropriate “Weed Free” buffers be provided on lands adjacent to WSDOT rights of way
4. Participating in joint control efforts contracted by weed boards

Lowest Priority

These are areas where there is no potential for neighbors to be in compliance with noxious weed regulations and there will be ongoing seed production onto the highway right of way.

Danger Trees

Dead, leaning, or structurally unsound trees within the right of way can pose a threat to the traveling public. They can also damage the pavement, structures, or other parts of the highway. Remove all danger trees as soon as possible after they have been identified.

When practical, debris and wastes may be left on site within the boundaries of Zone 3. The regional Maintenance Engineer will direct off site disposal or reuse of the wood. Danger trees outside the highway right of way (or permit boundaries such as in National Forests) may also be removed by WSDOT Maintenance. If possible, consult with the property owner where the danger tree was grown prior to removal. If an emergency exists due to a danger tree outside the right of way, remove the tree immediately and notify the property owner at the earliest opportunity.

In areas where logging activities occur, adjacent clear-cuts may create a fringe of unstable trees on the highway right of way if not removed or thinned at the time of the adjacent logging. Whenever possible dangerous trees should be removed prior to or in conjunction with the adjacent logging operation. The process for removal and disposal (or sale) of timber from state property is outlined in RCW 47.12.140.

Clear cuts adjacent to the highway may create undesirable views from the road. Especially on corridors designated as scenic and recreational highways, care should be taken to preserve and protect as much of the smaller trees and native vegetation on the right of way as possible to maintain the desirable visual character of the corridor.

Disposal of Logs Dumped on Right of Way

Logs dumped on any state roadway, in any state highway drainage ditch, or within 30 feet of the edge of pavement, are to be removed immediately. Logs that remain within the state right of way for a period of 30 days should be confiscated and removed or disposed of as directed by the Maintenance Superintendent.

The log transporting firm is required to immediately remove any logs dumped on the roadway or drainage ditch. If it becomes necessary for the WSDOT to remove such logs in order to comply with the law, the transporting firm will be billed for the operation including any damage to the highway.

If any logs are left on state right of way for a period of 30 days, the region will notify the transporting firm, by letter, that the logs have been confiscated by the state.

The method of disposing of such logs is at the discretion of the Regional Administrator, taking into account the merchantable value.

Removal of Dangerous Objects and Structures

WSDOT has the authority to remove any structure, device, or natural or artificial object located sufficiently close to a state highway to constitute a hazard or obstruction.

Maintenance personnel should not arbitrarily remove any object from the roadside unless the object represents a definite danger to the highway itself or to highway users. The matter should be brought to the attention of the region office for an initial decision unless immediate local action is required. In some cases “Memorandums of Understanding” are in place with agencies like the Forest Service and National Park Service in order to handle these issues in the areas where they have jurisdiction.

Trespass and Encroachment

All WSDOT Maintenance employees are required to obtain permission from property owners before entering private property, except in cases of an immediate emergency.

Encroachments- General

Maintenance field personnel are not expected to be familiar with all the laws and policies pertaining to the use of public right of way for non state highway purposes; however, they should at least be aware of the following basic facts:

No work of any kind shall be permitted on state right of way except that authorized by law. The department has adopted policies, rules, and regulations governing legal encroachments, and permission to occupy the right of way is always covered by a written permit, franchise, or agreement.

On some highways the access rights of abutting property owners have been purchased by the state. This means that no approach roads to the highway can be constructed except those authorized in the access control plan as a result of right of way agreements.

Encroachment- Maintenance Crew Responsibilities

Maintenance Superintendent assigned to sections are charged with the responsibility of reporting to their superintendent any evidence of intended or actual encroachment on the right of way by individuals, firms, or agencies for non state highway purposes.

Most violators are not aware of the law or have encroached inadvertently because of poor communication and/or unclear delineation of the right of way line.

Good public relations require that the local Lead Technician politely inform violators of the legal requirements as soon as an impending encroachment is observed, rather than to permit unauthorized work to proceed without such warning while the matter is being referred to someone else for handling. Major

work is quite often contracted, and a contractor's crew may not have knowledge of a permit or franchise even if one has been granted. By a radio inquiry to his area office, the maintenance technician can usually determine if authority has been requested or granted.

Generally it can be assumed that permission has not been granted for anyone to install or erect signs, sub-standard or otherwise, on the right of way. Contact the local maintenance and/or Region Traffic Office if there are questions about the legality of any sign.

Maintenance crews should be familiar with the right of way widths on their sections in order to detect possible encroachments.

Franchises and Permits

Franchises and permits are issued on standard forms that contain applicable legal requirements. Each encroachment document will include its exact location, any applicable special provisions required in the project, and how the installation is to be constructed.

A single application form, in which the applicant describes, with the aid of sketches and/or maps, what he wants to do, is used for both permits and franchises. An area or region employee makes a field investigation to determine whether or not the proposed work is permissible by law, what its effect will be on existing highway conditions, and what construction designs must be adopted to protect the interests and legal requirements of the state. If all is in order, the field investigator submits a recommendation that the application be accepted and approved and what, if any, conditions or restrictions should be included.

Maintenance should check to ensure adequate provisions are included for revegetation of any and all disturbed soil.

Franchises are issued for all utility encroachments that extend along the highway for a distance of more than 300 feet. Approval can only be granted by action of the department after the applicant has furnished proof that he has complied with all the legal requirements of posting and advertising.

Permits are issued for encroachments less than 300 feet in length. Permit forms are shorter than franchise forms and there are no posting and advertising requirements.

All permits on restricted access highways, and permits for any gas or petroleum products crossings except local gas service line, on any highway, regardless of access restrictions, must be approved by the department.

The department has extended authority to the Regional Administrator to approve all other encroachment permits, including those for local gas service crossings and for the cultivation and/or growing of agricultural crops.

See the Utilities Manual (M 22-87) for further information on WSDOT policy on franchises and permits.

The Use of Pesticides

Pesticides are an essential part of an IVM program. Herbicides are the major type of pesticides used by WSDOT. When applied properly as instructed on the product labels and used in combination with other vegetation management methods, herbicides are one of the most effective and economical tools available to the roadside vegetation manager.

Within the IVM decision-making process, herbicides are often used to achieve initial control of weed infestations. Once the infestation has been reduced or eliminated through herbicide applications, other methods can be employed for long-term vegetation management. Therefore, in a successful IVM program, overall herbicide use should decrease and applications become increasingly selective over time as beneficial competitors are allowed to become more established on the roadside.

Pesticide License

All pesticides applied by WSDOT including herbicides, insecticides, fungicides or other pest control agents, must be applied by WSDOT employees or contractors licensed through the Washington State Department of Agriculture (WSDA). Licenses are obtained by passing uniform tests administered by WSDA. In order to maintain a pesticide license, applicators must attend and receive credit for continuing education certified through WSDA. Forty (40) recertification credits are required every four years and no more than fifteen (15) credits can be counted for any one year.

Record Keeping

Record all pesticide application information on DOT Form 540-506 EF, Pesticide Application Record. A computerized database application is available to facilitate the record keeping process. State law, RCW 17.21, requires that records of all pesticide applications be retained for seven years. Send copies of all pesticide application records to the Headquarters Maintenance Office where these files are retained. Copies may be sent electronically via e-mail if entered using the computerized database. Otherwise, paper copies must be sent.

Product Labels

The label for each pesticide restricts how and where the individual product may be used. This protects the environment and non-target plant material, and ensures the safety of the applicator and the public.

Use of a pesticide inconsistent with the label instructions is prohibited by state and federal regulations. Individual pesticide applicators (even though employed by WSDOT) may be held personally liable in a case of misapplication. When planning for the use of pesticides consider all information available. This includes all information on the label of each pesticide container, plus all supplemental information provided by the manufacturer and the Washington State University Cooperative Extension Service.

Posting Requirements

Immediately after the application of pesticides, it is required that signs be posted in those areas that are intended for public access such as Safety Rest Areas and bicycle/pedestrian paths. RCW 17.21.410 lists legal requirements for posting public access. For all other applications made on the right of way with power equipment, posting is required in the form of placards on the spray apparatus. Requirements for posting right of way applications can be found in RCW 17.21.400.

Aquatic Pesticide Applications

Pesticide applications made in or over open water, or within delineated wetlands are subject to additional regulation and come under the jurisdiction of the Washington State Department of Ecology (WSDOE). Operators making such applications must have aquatic certification on their pesticide applicator's license and a special permit must be obtained through WSDOE. The permit includes limitations on the products available for use and provisions for public posting and notification. The Headquarters Maintenance Office is responsible for negotiating and maintaining statewide coverage for aquatic pesticide applications.

Pesticide Sensitive Individuals

State law requires that pesticide applicators, prior to making an application, will notify individuals who have been medically certified as "pesticide sensitive" and live within one-half mile of the highway application site. The WSDA maintains and annually updates a list of individuals who have received this certification and their addresses. The HQ Maintenance Office is responsible for supplying information on pesticide sensitive individuals to the maintenance areas where notification is required. RCW 17.21.420 explains the process and requirements for establishing the list through WSDA. RCW 17.21.430 explains the requirements for notification of individuals on the list.

Container Disposal

The Washington Administrative Code (WAC) 16-228-185(2) states in part: "No person shall transport, handle, store, load, apply or dispose of any pesticide, pesticide container or apparatus in such a manner as to pollute water supplies or waterways, or cause damage or injury to land, including humans, desirable plants and animals, or wildlife:...."

To comply with the law, all pesticide containers shall be triple rinsed (three times) each time, using a volume of an appropriate solvent (water, diesel, oil, etc.) equal to approximately 10 percent of the container's capacity. Rinsing of containers shall be accomplished as soon as possible after emptying. The rinse solution shall be added to the spray tank and considered as part of the pesticide carrier. Proper triple rinsing

removes the “hazardous” stigma from the containers. However, the rinsed container must still be disposed of in the proper manner, as listed on the pesticide label.

The need for rinsing and disposal of containers can be eliminated if products are available in refillable bulk containers. Utilizing bulk and “mini-bulk” containers and metered pumps to transfer products from the container to the spray equipment reduces the chance of human contact. Where this system is used in conjunction with injection type spray equipment, unused product may be returned to the bulk container at the end of the day.

Use of Mowing Equipment

Mowing is often used to achieve a neat and aesthetically pleasing appearance on the roadside, giving the impression of a high maintenance service level. However, mowing can also be an important part of an IVM program on the roadside. In this way mowing is used to maintain the desired service level in relation to controlling vegetative obstructions and nuisance vegetation in Zone 2. Use the minimum number of mowing cycles necessary to accomplish IVM objectives for the specific site. In some cases mowing cycles may be reduced to once every two or three years (or more) without compromising service level commitments.

Annual multiple mowing cycles of non-irrigated erosion control grasses that are not regularly fertilized will cause thinning of the plant population. This will reduce the grasses’ competitive capabilities and allow undesirable seedling trees, brush, and weeds to become established.

Avoid mowing in areas where wildlife habitat enhancement is a recognized part of the roadside management scheme. Essential mowing can be accomplished after the nesting period for upland game birds.

Do not remove more than one-third of the total grass height in a single mowing activity, unless the grass has produced seed and dried. Mowing frequency is dictated by this principle for turf areas in formally landscaped situations. Height of mowing for erosion control grasses shall not be less than 4 inches, and preferably between 6 and 8 inches.

Whenever possible, mowing activities should take place after erosion control grasses have matured and set seed. This is desirable for the health and long-term survival of the grass stand because it allows for root growth and development. It is also important to mow during the seasonal dry period to avoid damage to the grass stand from the tires of the mowers. Mowing when soil is wet causes tire slip and compaction. Tears and exposed soil from tire slip creates windows for erosion and weed invasion.

Do not mow newly seeded erosion control grass stands until the grass has been in place one full year.

As a rule of thumb, mowing will be necessary only for turf within formal landscaped areas, to improve sight distance, and to respond to local aesthetic considerations. When in doubt about the need to mow, look at the surrounding property. Keep the appearance of the highway roadside compatible with adjacent private property.

Other Cutting Methods

Use saws, axes, and other cutting implements to selectively remove individual plants or parts of plants, and to remove plants that are too large to remove by mowing.

When the total plant is removed by cutting, a follow-up application with an herbicide labeled to prevent re-sprouting at the stump may be used. Cutting conifer trees below the lowest limb will eliminate regrowth. Re-sprouting of any tree or shrub will be minimized if the cutting takes place in the summer after the spring growth period is complete. The months of July, August, and September are the most effective period in which to cut trees, brush, and shrubs.

Avoid non-selective trimming on the sides of trees whenever possible. Trees should never be topped. If possible, remove the entire tree rather than damaging its natural form by pruning or topping.

Pruning of trees and shrubs may be necessary to remove unsightly dead stubs or other conditions that may endanger the plant's health.

Cultural Control Methods

Enhancing the competitive capabilities of a desirable vegetation by meeting its nutrient, moisture, and light requirements enables it to dominate the plant community and crowd out undesirable vegetation. Except in irrigated landscapes it is generally not possible to affect the moisture available to plants. Selective removal of plants that are shading desirable vegetation that needs high levels of light can be done in an integrated management plan. Nutrients are supplied through applications of fertilizers that replenish a depleted food supply.

Cultural control methods are essential to establish a desirable plant complex for the future once the competitors have been eliminated by cutting and/or spraying.

Biological Control

Predators normally depend on a very small number of plant species for their survival. Which is what makes them effective control agents. However, a host plant will never be totally eradicated by biological methods alone. The population ratio of the host plant and its predator varies on a cycle of approximately seven years. When the population of the predator is high, it will dramatically reduce the population of the target host plant. However, when the host plant population begins to dwindle, fewer predators can be supported and the predator population will also begin to decrease.

Generally, biological control only works on introduced species of weeds that dominate due to a lack of natural predators in the ecosystem that the weed has invaded. In most cases, biological control measures are employed to suppress the spread of existing well established weed infestations.

Biological control combined with cultural control can sometimes lead to eradication of a weed species such as Tansy Ragwort. Cinnabar Moth larvae feed on the Tansy Ragwort blooms. A Seed Fly reduces seed production, and a Flea Beetle reduces the plant's vigor by feeding in the crown and stems. Tansy Ragwort is a biennial plant that blooms and then dies if seed is produced in the second year. By introducing the biological predators, the seed produced is very limited. This limited number of seeds has little chance of establishing as plants if the surrounding soils have grass or other native vegetation that has been enhanced by a good fertilizer program.

The Cooperative Extension Service through Washington State University can provide assistance in evaluating the potential success of a biological control program.

Burning Debris

Burning of brush, slash, tumbleweeds or any other waste shall be accomplished in a manner and time that conforms to the rules and regulations of the regulatory agency for that area. Contact local air pollution authorities and fire departments regarding burning requirements.

Illegal Tree Removal

RCW 47.40 states that removal or damage to any desirable plant on the right of way by an unauthorized individual is a misdemeanor and punishable by law. RCW 64.12.030 and 040 discuss how courts assess damages for injury or removal of desirable plants. In cases where actions are witnessed or where it is obvious who the perpetrator is, the state patrol and the Attorney General's Office should be called in for assistance.

Unauthorized removal of materials often occur when adjoining parties feel that the trees are blocking visibility across the highway right of way. A desire to have better visibility for their establishment, their product advertising, or simply wanting a better view of the surrounding area may lead these parties to remove vegetation without proper permission.

While it is difficult to continually monitor the entire right of way for this type of illegal activity, certain locations are more prone to neighbor's visibility issues than others and should be watched.

Significant Roadside Activities

Maintenance actions on the roadside can have a significant impact on adjacent property owners and others in the public. Involving appropriate customers in significant roadside maintenance activities will often help improve the public's

confidence in WSDOT's ability to manage its transportation system in a manner that is responsive to customer needs.

Advance coordination mandated by this policy may increase the initial cost of any project. But, better communication and public involvement will result in fewer complaints, enhance department credibility and improve public trust.

Definitions

Maintenance Activity: Any activity undertaken by WSDOT maintenance employees within or adjacent to highways rights of way to preserve, protect, and enhance the safe mobility of the traveling public, the highway facility, and the environment.

Significant Roadside Activity: Any activity that will substantially alter the visual appearance of a roadside. Significant activities include, but are not limited to:

- Removal of large stands of vegetation
- Grading to re-contour slopes or ditches
- Removal of natural or constructed noise or visual barriers
- Any activity that alters the visual appearance of more than 1,000 linear feet of roadside

Significant activities do not include ditch and culvert cleaning, herbicide applications, mowing, erosion/slide repairs, grass seeding/fertilizing, highway hardware repair/ installation, litter pickup and/or emergency activities that are required as a result of a national disaster.

Notification

Notify the public and appropriate agencies about upcoming significant activities at least one week prior to action. Notification may include, but is not limited to the following actions:

1. Telephone call
2. Flyer delivered to each residence
3. Mailed notice
4. Posted sign
5. Newspaper news release
6. Personal one on one contact
7. Posted notice on local bulletin boards
8. Public service announcement on radio or television.
9. Legal notice
10. Town meeting

Removal of Debris and Rubbish

Debris and rubbish deposited on or along the highway is picked up and disposed periodically as necessary. Debris such as fallen branches and articles that have fallen from vehicles, rocks or earth slides onto the traveled portion of the roadway or onto shoulders or ditches should be removed immediately.

The remains of animals killed by motor vehicles should be removed promptly and buried at convenient locations. If license tags are present on domestic pets, notification of appropriate city or county is encouraged. The Wildlife Road Kill Report, Form 335-002, should be completed, especially for deer and elk, and submitted to Headquarters. This record of killed wildlife aids in the placement of signing and other preventive measures.

Occasionally, items of value are cleared from the right of way. If possible, the owners of the property should be notified. Otherwise, the property is retained for 30 days and the area office is notified. Generally, owners of such property will contact the department. If the property is not returned to the owners, the region either places the item in inventory or declares it surplus.

Litter Control and Partnerships for Roadside Enhancement

Litter is highly visible. A clean or littered roadside creates a perceived indication of the overall maintenance service level. Litter control and local community roadside enhancement are not high maintenance priorities. Roadside partnerships allow WSDOT to accomplish roadside clean up and enhancement at minimal cost.

Responsibility for litter control on state highways is shared between WSDOT and the Washington State Department of Ecology (DOE).

DOE administers a fund generated through a state tax on the sale of all containerized goods, and is charged with leading education and prevention programs. DOE also utilizes a portion of the fund to pay for litter pick up programs which may be employed to assist with cleaning litter on state highways.

The majority of litter pick up initiated by WSDOT takes place through the administration of the Adopt-a-Highway (AAH) program. WSDOT maintenance employees typically pick litter in advance of mowing operations to prevent shredding and spread of litter by mowing equipment, or where large debris such as discarded furniture items and tire shreds are present and pose a hazard to traffic.

The largest maintenance expenditure for litter control results from the pick up and disposal of bags filled by AAH volunteers, and DOE sponsored programs.

Adopt-a-Highway

The Adopt-A-Highway Program (AAH) allows citizens and businesses an opportunity to contribute to a cleaner environment and an enhanced roadside appearance through partnership with the WSDOT. The program is authorized and governed by state law as defined in RCW 47.40.100.

The program is intended for use in those situations where a volunteer group or business entity wishes to help WSDOT in the performance of litter control or other activities that will enhance the appearance of the roadside. Any activity undertaken as part of this program must be in the primary interest of the traveling public and must contribute to an improved visual and/or environmental condition. The outcome of any activity must be compatible with the surrounding roadside conditions and the Department's overall policy and program goals.

Program Rules

It is important to maintain a level of consistency in administration of the program throughout the state, but the individual area maintenance offices must be somewhat flexible in their interaction with participating groups. Management of the program will therefore vary to some degree throughout the state; these rules and procedures are intended to provide consistency on state-wide programmatic and legal issues.

Participant Eligibility

Any organization, individual, family, business, corporation or combination thereof may participate in the Adopt-a-Highway Program by either voluntary efforts or by financially sponsoring roadside enhancement activities. The terms for each assignment shall be specified on the Adopt-a-Highway Agreement and subject to the following rules:

The name displayed on the AAH recognition sign shall be the official name of the organization, individuals, or business. Only the name may be displayed on the sign, no other information may be included. In the case of privately sponsored adoptions, where logo panels are provided by the sponsoring organization, additional information may be included if it is part of the organization's official logo.

Organizations shall not be eligible if their name:

1. Endorses or opposes a particular candidate for public office.
2. Advocates a position on a specific political issue, initiative, referendum, or piece of legislation.
3. Includes a reference to a political party.
4. Includes any words or reference to anything that may be considered or construed to be obscene to the general public.

Organizations whose agreements are terminated for failure to comply with terms shall be ineligible for participation until five years from the date of the termination.

Assignment of Sections

Sections shall be assigned on a first come, first served basis. Consider the type of location and anticipated volume of litter in relation to the type of group or privately sponsored adoption. Assignment of groups, locations, management of waiting lists and special limitations or restrictions are determined by the regions. Limit volunteer adoptions due to safety concerns in locations with high traffic volumes, high litter volume, or difficult access. Sponsored adoptions may occur anywhere except construction zones. Standard litter control sections range from a minimum of two centerline miles to a maximum of ten centerline miles in length. Single organizations may adopt as many sections as desired, but each section adopted by that organization on a given route must be separated by a minimum of ten miles in the direction of travel. Wherever possible assign new adoptions next to existing adoptions.

Sometimes the AAH Program is used to initiate a roadside enhancement in addition to or other than litter control. The activities may include planting projects or graffiti removal. In these situations assignments may be made for specific locations less than two miles in length, such as at interchanges or bridge crossings.

For type and placement of AAH participant recognition signs, see Traffic Manual (M 51-02) Chapter 2.7.J and Appendix 2-9, signs 16-901 thru 16-905.

AAH agreements last for a minimum period of two years. The termination or renewal date for all agreements is February 28, unless otherwise canceled by either party. Agreements can be terminated by either party upon 30 days notice. For routine two year renewals, organizations with previously assigned sections have first right of refusal for their sections upon renewal.

Interruption of agreements may occur due to highway construction or improvement projects. WSDOT will notify all affected participants in the event of interruptions. During this period the area will be reserved for the original participants. Upon completion of construction the original participants have the option of renewing or terminating the agreement.

In some cases it may be desirable to establish agreements for special clean-up or enhancement activities through a General Permit with Special Provisions for Roadside Maintenance.

Volunteer Adoptions

Volunteer adoptions are established through the form titled: Adopt-a-Highway Agreement for Volunteers (Form #520-029).

Each volunteer organization participating in the program shall have a designated leader or coordinator.

All participants shall be at least 15 years of age.

All participants will submit a signed volunteer registration form to WSDOT. This includes the requirement for signed parental consent to be submitted for all minors, (participants under the age of 18,) prior to their participation in any roadside activities.

During roadside clean up or enhancement activities, there shall be at least one adult supervisor present for every eight minors.

Upon completion of any and all AAH events, volunteers shall complete and submit to the Department within 7 days, a Volunteer Activity Participant Form #520-030.

Sponsored Adoptions

Sponsored adoptions are established through the form titled: Adopt-a-Highway Agreement for Privately Sponsored Work (Form #520-028). This is a three party agreement between WSDOT, the sponsoring organization and the organization providing the clean up or enhancement. WSDOT is not responsible for agreements or contracts made between a sponsoring organization and the organization providing the clean up or enhancement. Sponsored adoptions may be initiated by either a sponsor or a potential contractor wishing to solicit a sponsor. Agreements are granted on a first come, first served basis and will only be granted when a sponsor or contractor presents a copy of a signed contract to conduct the required work.

The cost of privately sponsored adoptions and the work involved is intended to be covered by the sponsor. The agreement between the sponsor and the sponsor's contractor must include provisions for all the equipment, materials, labor and insurance necessary to accomplish the work specified in the agreement. Sponsors are required to pay a fee to the Department covering the cost of sign fabrication, installation and maintenance. The fee is based on the size and total number of signs required to satisfy the agreement, times the average cost per square foot for fabrication and installation of the signs. The per sign cost also includes a nominal administration fee to help defer the cost of establishing the agreement and coordinating with the sponsor and the sponsor's contractor over time.

Each sponsoring organization shall have a designated contact person. Each organization providing clean up or enhancement work shall have a designated crew leader for each adopted section and a designated central contact for the organization.

If, during the agreement period, the sponsoring organization fails to meet its financial obligation for the activities specified, WSDOT will allow the organization providing the clean up or enhancement to continue work under the agreement for up to 30 days, at their own expense. If the organization providing the enhancement work fails to obtain a new sponsor within 30 days, the agreement automatically terminates and all agreed upon conditions for default shall apply.

If, during the agreement period, the organization providing the clean up fails to meet its obligation or otherwise dissolves its agreement with the sponsoring organization and discontinues work, the sponsoring organization has 30 days to find a new organization to provide the clean up. If the sponsoring organization fails to contract with a new organization to provide the clean up within 30 days the agreement automatically terminate and all agreed upon conditions for default shall apply.

Upon completion of AAH events, the organization providing the clean up completes and submits within 7 days, a Sponsored Contract Activity Report Form to the department.

General Permits for Roadside Enhancement

In some cases a General Permit with Special Provisions for Vegetation Management may serve as the most appropriate means to accomplish proposed roadside enhancement or special clean-up work. Use this as an option over an AAH agreement if:

- The permit Grantee is not interested in recognition through the AAH program
- The proposed work overlaps with existing AAH litter control assignments
- The proposed work is a situation where an abutting neighbor maintains such as a “No Spray” agreement
- The proposed work consists of a limited number of events.

Fill out all General Permits for roadside enhancement work using the AAH database program. This allows information to be recorded and accessed in relation to any questions regarding statewide roadside partnerships.

AAH Administrative Roles and Responsibilities

Each region, and each maintenance area has unique personnel resources and responsibilities. They must assign responsibilities for the AAH Program to fit their maintenance and operations management structure.

Maintenance & Operations Responsibilities

The Chief Maintenance Engineer will designate the AAH Program Manager. This position will be responsible for:

1. Establishing and maintaining standard procedures to provide uniform implementation of the statewide AAH Program.
2. Providing, maintaining and updating a statewide network database containing all participant information and standard forms, agreements, correspondence letters, and recognition certificates for the AAH Program.
3. Developing, producing, updating, and distributing to the regions all public information on the AAH Program. This includes brochures, safety literature, safety videos and State Department of Transportation web site.
4. Maintaining records on all participating sponsored contractors including proof of insurance, and activity reports.

5. Coordinating or assisting the regions in coordination of AAH partnerships through out the State including litter control and enhancement efforts.
6. Overseeing and commenting on all procedures and issues relating to the AAH Program including review of all proposed agreements which include enhancement activities other than litter control prior to signature.
7. Pay premiums or assessments required under the Revised Code of Washington (RCW) 51.12.035 to secure medical aid benefits under Chapter 51.36 RCW for all volunteers participating in the Program.
8. Record all agreement information and participant activity on the state-wide AAH Database and update as needed.

Region Responsibilities

The Regional Administrator may delegate responsibilities for regional management and operation of the AAH Program to best serve the Program in that region. Day to day interaction with AAH participants will occur at the maintenance area level, but the area offices will receive varying levels of assistance from the Regional Offices throughout the State. The Regions shall delegate responsibility for the following:

1. Assignment of participating groups or sponsors to appropriate sections of highway.
2. Work with potential partners to develop proposals for roadside enhancement other than litter control.
3. Determine appropriate specifications for all agreements, including frequency of litter pick up and special provisions and plans for special enhancement projects.
4. Inform, and discuss if requested, with the Washington Federation of State Employees; Regional Chief Shop Steward, any projects other than volunteer litter control prior to approval of the agreement.
5. Erect and maintain AAH Recognition Signs in accordance with signing guidelines contained in the Traffic Manual (M 51-02) Chapter 2.7.J.
6. Furnish volunteer groups with trash bags, "Adopt-a-Highway Crew Ahead" advanced warning sign(s) and stand(s), a warning light, hats and vests for all volunteer participants, and all or a portion of the materials and provide assistance required for implementation of enhancement projects other than litter control.
7. Distribute safety information, training aids and provide consultation to volunteer groups and sponsored contractors.
8. Pick up and dispose of litter bags collected by volunteer participants.
9. Collect and distribute funds paid for privately sponsored agreements to cover costs of sign fabrication, installation and maintenance, and processing agreement.

Auxiliary Facilities

Safety Rest Areas

Safety rest areas have been developed throughout the state adjacent to the highway and within the right of way. These facilities provide places where motorists can get off the highway for short periods to nap, stretch, snack and/or use the restroom. They also provide a safe place to pull over and telephone for help in the event of

vehicle break down. Rest areas contribute to highway safety by allowing drivers to become refreshed and more alert when they resume their journey.

Regular maintenance of rest areas is important. A clean functioning rest area gives visitors and taxpayers a good impression of the state and of WSDOT. Frequency of maintenance depends largely on the use of the individual areas. Clean and service rest rooms at least twice per day or at four-hour intervals during periods of high use. Empty all trash cans. Pick up ground litter and have it removed on schedule. Wash and clean picnic tables and benches at least once a week or as often as necessary to maintain a neat appearance.

A poorly maintained safety rest area will tend to collect added trash. Users will have little respect or desire to put his trash in a litter barrel when large amounts of trash are already scattered about. Similarly, graffiti and other vandalism must be quickly repaired or additional abuse is likely. Some areas with toilets that are maintained by the department must receive extra attention and be maintained to a high degree of sanitation. Sewage disposal facilities need scheduled maintenance of septic tanks, drain fields, pumps, filters, and back-flow prevention devices. In some rest areas chemical toilets are provided and maintained under private contract. Check them to assure that they are properly maintained. If they need attention or if there is indication of vandalism, report it immediately.

Some areas are provided with drinking water from springs or wells. Check these regularly for repair and sanitation. Take test samples of water to ensure a clean water supply. Turn off or divert contaminated water supplies until the source of contamination is found and corrected.

Park and Ride Lots

It is the policy of WSDOT to plan, coordinate, develop, and implement effective partnerships for park and ride facilities. Clean, well maintained facilities help to instill a sense of confidence and safety for the users. Maintenance is critical for customer and vehicular safety, accessibility, utilization, protection of the infrastructure investments, and reduction of potential liabilities for the Department and/or transit agency.

Whenever possible, maintenance of park and ride facilities is arranged through agreement with the local transit agency. In cases where WSDOT maintenance is responsible for care of a facility, the WSDOT Park and Ride Facilities Manual (M 3010.00) provide guidance on activities and procedures.

Historical Markers

Historical markers and other interpretive signing within the right of way are maintained jointly with the Washington State Parks and Recreation Commission. Historical or interpretive signs and associated structures are maintained by Parks.

WSDOT maintains road approaches, parking areas, litter barrels, and advance advisory signing.

Viewpoints

Viewpoints have been provided at many scenic locations. Like safety rest areas they are a definite asset and safety factor to the motorist. They generally consist of a parking area with litter barrels. Maintenance requirements are not as intense as for rest areas. But, viewpoints do require regular checks to keep litter barrels emptied and trash picked up. Maintain parking areas and keep fences and guardrail in good in good repair. Assure all warning signs are in place and clearly legible. Remove all undesirable brush that would reduce sight distance and obstruct the view. Dispose the debris away from the viewpoint.

General

Removal of snow and ice from the roadway is extremely important and takes precedence over all non-emergency work.

The roadway must be plowed, sanded or deiced if necessary, and widened as quickly as possible. Snow and ice removal continues until the job is done, even if it involves working extra hours at night, weekends, or legal holidays. Work vigorously to maintain the roads in as good a condition as is possible with the equipment, materials, and personnel assigned to the work.

The department's policy is to remove snow from all high priority regularly traveled highways. After priority highways are cleared, snow removal occurs on lower priority highways according to established region/area criteria.

Some mountain passes are closed each year once deep winter snows arrive. These road closures occur where light traffic and deep snowfall does not justify the hazard and expense of attempting to keep roads open.

The snow removal operation is intended to provide the prudent motorist with a reasonably safe traveling surface. Although plowing starts soon after the storm begins, it takes time to complete the operation. During heavy snowfalls there may be periods of time when the roads will not be sanded or deiced and the motorist may need to install chains or other traction devices.

Safety for the traveling department and public personnel is the primary consideration at all times.

Economy and efficiency of operation is the goal of all maintenance personnel.

The Snow and Ice Plan is available to view at:

http://wwwi.wsdot.wa.gov/maintops/SI_PlanNovember04-1.pdf

Preparation for Winter Operations

Make plans early for winter work. Get snow plowing equipment, anti-icing/deicing equipment, sanding equipment, radio equipment, equipment operators, deicing materials, sanding materials, and supplies including signs, flags, barricades, small tools, and equipment parts ready for the first frost or snowstorm. Don't be caught unprepared for an early snow.

Prepare each roadway for effective plowing.

- Keep side ditches clean.
- Shoulders should be smooth and flush with the pavement.
- Clean sand out from under guardrail.
- Cut and remove all tall weeds, grass, and brush that may cause snow drifting.
- Clear right of way fences of wind-blown weeds and sand drifts.
- Erect snow stakes, if necessary, to indicate hazards or the edge of the roadway which may be covered with snow.

Each Area Maintenance Superintendent has maps that shows local priority routes for anti-icing, snowplowing and sanding in multilane and urban sections. Equipment operators are responsible to study the maps and become thoroughly familiar with the priority routes. These maps are available at each maintenance section shed before winter begins.

Maintenance Supervisors are responsible to:

- Assure their employees know what is expected of them.
- Keep records that document work directions given to crews.
- Instruct all operators in the proper operation and maintenance of equipment.

WSDOT has a Winter Snow and Ice Training Program in place that instructs employees on how to properly perform winter anti-icing, deicing, snow plowing and sanding. This training especially targets the intermittent, seasonal and new permanent employee.

Calibrate each sand spreader to make the spreads required at a reasonable speed. Several drivers typically operate the same piece of sanding equipment during the winter. Some drivers may not be familiar with the specifications (or quirks) of a particular vehicle. To remedy this, post a card in the cab of each vehicle showing the truck speed or tachometer reading and adjustment to the spreader to deliver specified spreads. Variations from this calibrated rate may be necessary in accordance with actual field conditions.

Get stockpiles of sand ready for winter use. Locate stockpiles on smooth surfaces. If possible, set stockpiles up to work from the south side with maximum exposure to sunlight. Get loaders ready for operation at these sites.

Snow and ice control chemicals should be mixed into winter abrasives stockpiles only at locations where cold winter weather would typically freeze an un-conditioned stockpile.

When abrasives stockpiles are conditioned, either rock salt or solid, corrosion-inhibited chemicals may be used for this purpose. No more than the minimum amount of chemicals needed to keep the abrasives stockpile workable

should be used. In many locations around the state, this will be a ratio of 20:1 (twenty parts abrasives to one part chemical) by volume. In some areas with wetter climates, a stronger concentration, up to 10:1, is required to keep stockpiles from freezing.

At times, stockpiles are conditioned at a rate stronger than the minimum concentration needed to keep them workable so that ice-melting capabilities are added to the abrasives. This is generally viewed as a less-than-optimal approach to snow and ice control. The current belief is that straight chemicals should be used to melt snow or ice and that adding abrasives to this equation results in costs and adverse impacts that outweigh its benefits. However, if maintenance personnel are working with some unique circumstances where such a mixture provides the most cost-effective method for improved road conditions, they can mix and use stockpiles with stronger concentrations of anti-icing chemicals. In such cases of stockpiles being conditioned at a chemical concentration of stronger than 10:1, only corrosion-inhibited chemicals shall be used.

Highway Categories

The priority of maintenance given to a state highway facility is influenced by the functional class and amount of use (traffic) that it receives. In general highways are prioritized according to the following categories.

Category -1- Highway

Interstate with an ADT (greater than) > 80,000

Category -2- Highway

Interstate or Principal Arterial with an ADT (greater than) > 20,000

Category -3- Highway

Interstate or Principal Arterial with an ADT (less than) < 20,000

Minor Arterial with an ADT (greater than) > 10,000

Category -4- Highway

Principal Arterial with an ADT (less than) < 10,000

Minor Arterial with an ADT (less than) < 5,000

Collector with an ADT (greater than) > 5,000

Category -5- Highway

Principal Arterial with an ADT (less than) < 5,000

Minor Arterial with an ADT (less than) < 5,000

Collector with an ADT (less than) < 5,000

Special Criteria

The priority of a highway may be raised or lowered a category, based on the following special criteria:

1. Importance to commerce, truck routes, etc.
2. Important commuter routes
3. School bus routes
4. Proximity to population centers
5. Curvature and grade of highway alignment

Work on State Highways

Area of Responsibility. Snow and ice control operations on state highways are restricted to the highway right of way. This includes those portions of intersecting public roads that are within the state highway right of way.

Snow Control Operations. Snow control operations consist of removing accumulated snow from the traveled way, shoulders, widened areas, and public highway approaches within highway right of way. When accumulated snow becomes compact and removal is not possible with available equipment, the accumulation is treated as an ice control operation.

Ice Control Operations. Ice control operations are done on the highway and on public accesses within highway right of way. This can consist of pretreatment of the roadway surface with anti-icing chemicals or the application of abrasives and/or deicer chemicals. When removal of compact snow and ice is not immediately possible, an abrasive application at bridges, curves, intersections, railroad crossings, steep grades, and isolated shaded areas is acceptable. Ice and compact snow are best removed under thawing conditions.

If possible, schedule ice and compact snow removal operations during the temperature rise that often occurs between 11:00 a.m. and 3:00 p.m. Use this time to clear surfaces of melting snow and ice, and to remove as much slush as possible prior to evening temperature declines. The use of road graders for ice removal is most effective during this period. Proper use of this warmer temperature period can make the difference between efficient and non-efficient cleanup operations.

Anti-icing & Deicing Chemicals. The use of anti-icing and deicing chemicals containing reduced chlorides such as Calcium Chloride and Magnesium Chloride or no chloride like Calcium Magnesium Acetate is encouraged. Use anti-icers/deicers in all areas where the Regional Administrator has determined there are benefits of such application.

Adverse impacts of a storm can be reduced when forecasts are used to apply anti-icing chemicals. Roadway weather information systems such as "RWIS" help WSDOT estimate the onset of road surface ice. With this information maintenance crews can apply anti-icing treatments just before a storm or ice condition hits.

Level of Service Coordination. Proper snow and ice control operations include coordination between adjacent regions. This assures that obvious changes in level of service on continuous sections of highway are avoided.

Tandem Plowing. Tandem plowing can be used for snow removal on multilane highways. Where reversible plows are available, it is often advantageous to operate one plow toward the left plowing to the median strip. In areas where drifting snow is a frequent problem, caution should be exercised in placing snow on the median. A narrow median filled with snow can cause drifting in adjacent lanes. Also, melting snow in the median can cause icy roadways during colder nights. Take care to assure that plowed snow is not thrown into the path of oncoming vehicles or onto a roadway below the highway being plowed.

Spinner Shut-off. In most cases spinner assemblies are used to distribute abrasives. In these situations, turn off the spinner temporarily when the sanding truck meets oncoming traffic. Stop sanding temporarily to allow backed up traffic to pass.

Operations at Interchanges. Interchange ramps are considered as separate roadways independent of the highway they serve. Priorities are determined by traffic volume. Ramp roadways are normally treated after one or more lanes are open on the main roadway.

Railroad Crossings. Never leave a windrow of snow on a railroad grade crossing. Drivers are to raise or otherwise adjust the blade before reaching the crossing to prevent damage to the crossing and/or equipment. Be aware of and avoid any conflicts between snow removal operations and approaching railway traffic.

Widening. Widening for snow storage, established turnouts, mailboxes, etc., may be accomplished when available manpower and equipment permit. Shoulders are often plowed in conjunction with the traveled way, or immediately after the storm is over. Clearing shoulders provides storage space for additional snow, makes the highway safer for motorists, helps prevent drifting, damage to the roadbed from moisture infiltration, and excessive runoff onto the pavement. Perform shoulder plowing in the direction of travel. Always establish proper traffic control before plowing against traffic on the median shoulder of divided highways.

Drainage Ways. Clear all drainage ways from the roadway surface prior to thawing conditions. Utilize a road grader or wing plow if possible.

Highway Sign Installations. Clear snow-covered highway signs after normal snow and ice control operations have been accomplished. Give first attention to regulatory and warning signs.

Construction Projects. Perform state-force snow and ice control operations on construction projects only if the project is open to traffic. Before beginning, assure that appropriate arrangements between region maintenance, construction staff and the contractor have been agreed to.

Pedestrian Facilities. In some urban locations, plowing operations may clog sidewalks or other pedestrian facilities. Regions need to initiate coordination with local jurisdictions in the fall to establish responsibilities and priorities for keeping pedestrian facilities free of snow. Keep in mind that areas outside the curb line are a city responsibility.

City Streets on the State Highway System

RCW 47.24.20 defines the jurisdiction of the state and the cities for those city streets that serve as a part of the state highway system within the corporate limits of a city.

In respect to snow and ice control, the law provides that a city or town shall remove all snow at its own expense. Except, WSDOT is responsible to plow snow on the roadway when necessary. Cities are also required to clean the streets, including catch basins.

Cities generally plow city streets and are expected to plow the state highways in the city as well. State crews are expected to assist by plowing on the way through town. However, plowing on city streets is a secondary priority to be completed after rural lanes have been cleared.

The general exception is routes within cities that are designated as limited access highways. In those instances, the state exercises full responsibility for the entire facility and all maintenance operations.

Work on Other Roads and Areas

Other Governmental Agencies. Snowplowing for other governmental agencies may be performed when authorized, on a reimbursable basis. When winter operations are conducted for other agencies, agreements are processed by the Region Administrator or his/her authorized representative.

Snow and ice control operations on roads and other facilities under the jurisdiction of other governmental agencies are secondary to work on state highways. Work is completed in accordance with the provisions of the agreement with the other governmental agency.

Private Approaches. Snow and ice control on private approaches, including that portion that may be located within the state highway right of way, is the responsibility of the abutting property owner.

WSDOT does not remove snow, ice, or sleet from private driveways, including any portion that may be located within the state highway right of way. All such activities are the responsibility of the abutting property owner.

Snow and ice control activities may inadvertently result in the deposit or the wind rowing of snow, ice or sleet onto private approaches. The department does not assume responsibility for the removal or clearance of such material, even if caused by normal winter maintenance operations. However, all employees involved in snow control operations are expected to be sensitive, considerate, and courteous when carrying out these policies.

Mailbox turnouts on the shoulders may be plowed as a part of the shoulder widening operation.

Abandoned or Illegally Parked Vehicles

RCW 46.55.085 allows the State Patrol to impound abandoned or illegally parked vehicles after documented attempts to notify the owner. This process can require several days. However, if the vehicle is determined to be a hazard, the Patrol can arrange for immediate removal. The State Patrol has requested that WSDOT record any department requests for such removal, in order to support the Patrol's actions should a conflict arise with the owner of the vehicle.

Closures

Occasionally winter conditions are so severe they overwhelm the capability of maintenance crews to effectively respond. This happens despite our best planning efforts and highly motivated crews. Temporary road restrictions or closures may be the only safe alternative in these situations.

The Secretary or his designated representative may temporarily close or place temporary traffic restrictions on any state highway for any reason. The Secretary or designee may also close any state highway, without delay, in an emergency. When it becomes apparent that a road section will be closed by snow, ice, snow slides, or for any other reason, maintenance personnel must take immediate action to safeguard themselves, and the public.

The following actions are taken when a road must be closed for more than an hour.

- The Regional Administrator or designee notifies the State Patrol and other pertinent organizations.
- Immediately erect appropriate traffic control devices advising motorists of the closure and possible detours.
- Take all necessary measures to prevent motorists from entering and becoming stranded in the closed section.

- Keep the Regional Public Information Officer apprised of road conditions so that the news media can be informed of closures. Emergency closures require that the Area Superintendent, Regional Maintenance Engineer, Regional Administrator and the Regional Public Information Officer be notified as soon as possible.
- Keep the State Maintenance Engineer informed of all closures that are expected to last for four hours or more and of all actions taken to reopen the roads.

Emergency Assistance

During winter maintenance operations, limit emergency assistance to actions that safeguard life and property. Time spent helping motorists with minor problems could result in road conditions that would cause more serious problems for other motorists.

Employees may render emergency assistance to motorists, at the motorist's request. Stranded vehicles may be pulled onto the highway, provided the vehicle is driveable. The motorist must make his/her own tow chain or cable hookup and disconnect. This kind of assistance is typically permissible only when snow or ice conditions are reasonably under control and when private towing trucks are not available.

It may be necessary occasionally for an employee to exercise judgment as to whether a motorist is capable of driving his vehicle. Sometimes it appears that the motorist is inebriated or otherwise unsuited to drive. In these situations notify law enforcement agencies by radio or other available means as soon as possible. Employees are required to notify the State Patrol about any accidents that occur on the highway.

Never tow any vehicle that may be unable to proceed because of lack of power or traction, except when the vehicle blocks the traveled way. In this instance, the stalled vehicle may be towed a sufficient distance to clear the normally traveled portion of the roadway to allow the safe passage of other vehicles.

Department employees may not accept compensation of any kind for this or any other type of assistance.

WSDOT desires to avoid situations that can cause the department or its employees to be sued. This has resulted in a general policy that non-employees do not ride in state-owned vehicles. However, employees may provide transportation in state-owned vehicles to stranded motorists under emergency conditions. Employees are advised to consider the particular circumstances and exercise careful judgment.

Precautions

Take precautions to prevent damage to signs, mail box posts, sign posts, and other roadside appurtenances. Rotary snowplow operators are to reduce speed when in an area where adjacent buildings or facilities might be damaged from the flying snow. Redirecting the chutes helps minimize this danger. Utility lines and transformers can also be damaged by rotary plows.

Trucks must be operated at moderate speeds when removing snow, especially when slush exists. When plowing shoulders or when meeting traffic, operators need to be aware of what is going on around them. Stop or slow down occasionally to allow traffic from the rear to pass. Plowing slush at high speeds deposits the slush on signs and other vehicles and thereby obliterates warning signs. Plowing snow at high speeds causes excessive snow clouds, making the highway less safe for the traveling public.

Be especially careful when passing or being overtaken by other traffic. Avoid throwing snow onto windshields and obstructing the vision of other drivers.

Take care while removing snow in the vicinity of cars parked adjacent to the highway. Even though the cars may be illegally parked on the traveled way, take reasonable care consistent with the necessity of accomplishing the work.

Raised traffic buttons are often used in western Washington for lane stripe delineation. Care must be taken to minimize damage to the raised traffic buttons. Snowplows with rubber bits are used for this purpose—they are effective in slushy snow or in snow that has not been compacted by traffic.

Service Level Quality Measurement

The Headquarters Maintenance Office has developed quality performance measurements for snow and ice control. These performance measurements have been established to assess how well maintenance offices are able to control snow and ice. The purpose is to find the best ways to do our jobs with reduced funding and personnel. These measures focus on providing targeted levels of service for snow and ice control based on the highway category and local maintenance area priority. For more details on how this process affects you, check with your supervisor.

General

Traffic services are maintenance functions necessary for the safe and efficient movement of traffic. These include maintaining highway signs, delineators, pavement markings, traffic islands, curbs, impact attenuators, barriers, guardrail, traffic signals, and highway illumination. Each serves a definite function in the control and guidance of traffic. Functions that utilize electricity, including traffic signals, ramp meters, data accumulator systems, changeable message sign systems and highway illumination systems are discussed in Chapter 10.

The application, installation, and maintenance of all traffic service functions must conform to the accepted practice and standards set forth in the FHWA Manual on Uniform Traffic Control Devices (MUTCD), the WSDOT Design Manual, the WSDOT Maintenance Time Standards Manual, and the WSDOT Standard Plans for Road, Bridge, and Municipal Construction.

Reconstruction Principles

The following are samples of items that are subject to reconstruction to meet current design standards. The list is not all-inclusive but serves to illustrate the updating that can be accomplished.

- Breakaway bases on all sign supports and luminaire poles.
- Guardrail terminals and transitions.
- Guardrail post spacing

Use the “K Job Estimating Program” to estimate the cost of repairing damaged highway hardware in kind. When upgrading damaged hardware to current standards, attach a sheet to the Repair Cost Estimate to document why the original installation does not conform. This sheet will also show estimated additional materials, labor, and costs to bring the installation up to present design standards. Where possible, take photographs before and after repair and updating and include in the job file.

The Maintenance Program is intended to fund the repair or replacement of damaged or broken highway appurtenances to current standards.

Use federal aid interstate participation to fund the total cost of updating on interstate highways. If there are any recovered funds from responsible motorists, subtract these from the amount used to match federal aid interstate participation.

Repair and updating is accomplished by state forces or by contract. On state force work, include the work order number to be charged against on employee time sheets. A standby contract will be used to provide early contractor mobilization to assure fast repair of critical highway hardware damage.

In a region level contract, the Regional Administrator awards a contract in accordance with the delegated authority for contracts of \$50,000 or less and the provisions of M 27-02, Highway Projects of \$50,000 or less (State Funds Only), and M 27-20, Federal Aid Processing Procedures for Minor and for Standard Projects and State Force Work. WSDOT Headquarters contracts will normally be administered by either the Northwest Region or the Eastern Region in the case of western/eastern multi-region contracts.

Signing

Highway signs are erected to convey specific messages to the traveling public. They provide regulatory, warning, and guidance information.

Signing Responsibility

The Regional Traffic Engineer has the authority for the design, location, height, and other features associated with the installation of new signs, and for any revisions that may become necessary.

Region maintenance personnel are responsible for maintaining signs once they are in place, in consultation with the Regional Traffic Engineer.

Sign Installation

Most signs are mounted at approximately right angles to approaching traffic. Parking signs may be installed at an angle 30 degrees or 45 degrees or even parallel to approaching traffic in order to provide visibility to vehicles adjacent to the sign.

Orientation. Normally, signs should be vertically-mounted at right angles to the direction of, and facing, the traffic that they are intended to serve. Where mirror reflection from the sign face is encountered to such a degree as to reduce legibility, the sign should be turned slightly away from the road. Signs that are placed 30 feet or more from the pavement edge should be turned toward the road. On curved alignments, the angle of placement should be determined by the direction of approaching traffic rather than by the roadway edge at the point where the sign is located.

Sign Clearance. Erect signs and their supports with maximum practical lateral and vertical clearance in accordance with the MUTCD or chapter 820 of the *Design Manual*. This will provide the most safety for motorists who may accidentally leave the roadway.

The near edge of signs is normally located more than 6 feet outside the edge of shoulder or 12 feet from the edge of the traveled lane. Where curb exists, locate the near edge of the sign no less than 2 feet from the face of the curb.

Take care when installing signs and their supports behind roadside barriers. Many barriers are designed to deflect upon impact. An inappropriately located sign or support within that area could prevent proper functioning of the barrier and may result in a potentially hazardous situation. Do not locate signs or supports within the deflection areas listed below:

Barrier Type	System Type	Deflection
Cable Barrier	Flexible	11.5 ft.
Beam Guardrail Type 1, 1a, and 10	Semi-rigid	3 ft.
Double sided beam guardrail Type 3 and 4	Semi-rigid	2 ft.
Concrete Barrier- Unanchored	Unrestrained-rigid	2 ft.
Concrete Barrier- Anchored	Rigid	No Deflection

Use two checks when determining the height of post-mounted signs.

1. Assure the vertical clearance from the bottom of the sign to the roadway surface meets MUTCD specifications. This ensures good visibility.
2. Install signs as shown in the standard plans. This ensures that the safety mechanism (i.e., breakaway, slip base, load concentrating coupling, etc.) of the support system will function properly.

Maintenance

Keep all signs in proper position, clean, and legible. Conduct periodic day and night inspections for position, damage, legibility, and general condition. In addition, check sign structures and sign-to-structure connections for structural integrity.

Inspection. In snowy areas, signs may be damaged by plows or by thrown snow or ice. Inspections are most effective after the winter weather has ended. Another inspection is recommended in the fall to ensure readiness for winter driving. In areas where weather is less severe, inspections may be correlated with other maintenance work.

Periodically check sign bridge and cantilever structure end post and metal sign post base connections. In addition, inspect sign mounting bolts and beam clips for proper tightness. Replace or secure missing or loose hand hole covers on overhead sign structure supports. Give special attention to steel sign post base and fuse plate connections. To properly function as a breakaway support while resisting wind loading, the bolt torque specified in the standard plans must be maintained.

Field Repair. Good judgment and sound economics dictate when to perform field repairs. Field repair minor sign damage whenever possible. More extensive damage normally requires sign replacement. Signs such as STOP and YIELD, whose absence can be life threatening, must receive priority replacement.

Signs that are repeatedly knocked down by vehicles may be reinstalled farther away from the roadway or at a different location along the roadway. Care must be taken to ensure that the new location meets MUTCD requirements.

Sign supports within the “clear zone” described in Chapter 2 must meet functional requirements of current safety standards. Sign support design elements are shown in the standard plans.

Never weld the steel sign post web to prevent wind blow-down. Proper fuse plate bolts and bolt torque will prevent blow-down.

Along with proper bolt torque, the area around the sign post base must be clear of obstructions that may prevent the post from slipping free of the base. Ensure that the base stub-post does not project more than 2 ½ inches above the ground. Projections above that height may snag the undercarriage of a vehicle.

Sign Visibility

Promptly remove obstructions that prevent adequate sign visibility. Vegetation trimming is sometimes necessary to ensure adequate sign visibility. Maintenance crews must be particularly careful to avoid parking equipment in front of traffic signs.

At times, highway sign faces are obscured as a result of roadway snow removal. Clear all signs as soon as possible. Regulatory and warning signs have first priority.

Sign Storage and Transportation

Store signs indoors whenever possible to prevent sign sheeting failure. The signs may be packaged if dry. If packaged signs become wet, immediately unpack and separate them to allow drying.

At times, it is necessary to store signs outside. In this situation, remove the packing materials so that nothing is against the sign face. Never lay signs flat. Water accumulating between signs laying flat will cause sign sheeting failure.

Store signs upright on edge on blocks or other material to keep the signs off the ground. Install spacers, along the sign edges to allow air circulation and normal moisture evaporation from the sign face. Avoid sign sheeting contact with treated wood. Avoid storage where dirt or water may splash on the sign face.

Transport signs on edge, face to face or back to back, to prevent sign face damage.

Delineation

Delineation is defined as one, or a combination of devices, (excluding signing), that warn or provide guidance to the roadway user. These devices include pavement markings, guideposts, guardrail delineators and barrier delineators. Delineation of environmentally sensitive areas are identified with specifically marked green guideposts.

Pavement Markings

Pavement markings are divided into two categories, long line and transverse. Long line markings are the markings that are applied parallel to the roadway. Typically long line markings are renewed with a spray application of new material applied from a striping truck. Typically transverse markings are renewed by hand by spray application of new material.

Long line markings include the following: Skip center stripe, no-pass stripe, double no-pass stripe, lane stripe, edge stripe, dotted extension stripe, gore stripe, dotted gore stripe, skip gore stripe, drop lane stripe, barrier stripe, two way left turn stripe and reversible lane stripe.

Transverse markings include the following: Crosswalk stripe, traffic arrows, traffic letters, handicapped parking stall symbols, high occupancy vehicle symbols, railroad crossing symbols, cycle detector symbols, drainage markings and aerial surveillance markers.

Raised pavement markers (RPMs) are installed either as positioning guides along with longitudinal markings or they are installed as a complete substitute for long line markings. Surface mounted RPMs are installed on roadways where snow removal operations use rubber blades. Recessed RPM applications consist of the installation of an RPM in a groove that has been cut into the pavement. Recessed M applications are allowed in areas where snow removal operations use steel blades. Various markings are identified by color code as follows:

RPM Type	Color
Type 1W	White non-reflective
Type 1Y	Yellow non-reflective
Type 2W	White one side only
Type 2WR	White and red
Type 2Y	Yellow one side only
Type 2YY	Yellow both sides
Type 2YR	Yellow and red

Descriptions and dimensions of markings are shown in the Standard Specifications, Section 8-22 PAVEMENT MARKINGS. Application requirements for various markings are shown on the Standard Plans, noted by type as follows:

Marking Application	Standard Plan
Skip Center Stripe	H-3
Skip Center Stripe with RPMs	H-3
Lane Stripe	H-3
Lane Stripe with RPMs	H-3
Left Turn Channelization	H-3a
Left Turn Channelization with RPMs	H-3a
Two Way Left Turn Lane	H-3a
Single Lane On and Off Ramps	H-5
Drop Lane Stripe	H-5
Two Lane On and Off Ramps	H-5a
Collector Roads	H-5b
Traffic Arrows	H-5c
Crosswalk	H-5c
HOV Lane Symbol	H-5c
Handicapped Parking Symbol	H-5c
Aerial Surveillance Marking	H-5c
Railroad Crossing Symbol	H-5c

RPMs installed as positioning guides along with longitudinal markings are shown on Standard Plans H-3 and H-3a. RPMs installed as substitute applications for longitudinal markings are shown on Standard Plan H-5d.

Materials

Pavement markings are renewed with a material that is compatible with the original application material. Painted markings are renewed at a thickness of 0.015 inches or 15 mils. The application guns should be adjusted to a lower millage if tracking occurs. The paint is applied at a rate of seven pounds per gallon. Thermoplastic markings are renewed at a thickness of 45 mils for long line markings and 90 mils for transverse markings. Methylmethacrylate markings are renewed at a thickness of 45 mils for long line markings and 90 mils for transverse markings. RPMs are replaced in kind.

Application

Apply all pavement marking materials in accordance with the material manufacturer's recommendation. Apply all materials when the pavement is clean and dry. Moisture in the pavement is the major cause of most marking failures. Apply paint and thermoplastic materials when the pavement temperature is 50 degrees and rising. Methylmethacrylate material can be applied when the pavement temperature is 40 degrees and rising, provided the pavement is dry.

Paint and methylmethacrylate material is purchased by the liquid gallon. Thermoplastic material is purchased by the pound, then heated and applied as liquid. Material requirements for pavement marking materials for a continuous 4 inch line are as follows:

Millage	Gallons/Mile (Liquid)	Pounds/Mile (Dry)
15	16.4	-
45	49.2	875
90	98.3	1750

The Striping Supervisor is advised to contact the area Maintenance Supervisor in advance of any long line marking applications to coordinate maintenance activities and arrange for sweeping of the roadways.

Marking Renewal or Replacement Frequency

Pavement markings are renewed when they no longer provide guidance during daytime and nighttime conditions. Markings that may appear adequate in the daytime may have no reflectivity at night. Typically markings fail by loss of reflectivity long before they fail by daytime appearance.

Renew applications on the following schedule:

Marking Type	Frequency
Long line painted markings	At least once a year
Heavy wear long line painted markings	At least once a year
Thermoplastic applications	At least once every two years
Methylmethacrylate applications	Every five years
Reflective RPMs (except yellow)	By group every two years
Reflective yellow RPMs supplementing the yellow edge lines on divided highways	Every four years
Non reflective RPMs	Replaced as needed when the associated reflective RPMs are replaced

Removal of Markings

Removed pavement markings can sometimes reappear and confuse motorists. All removed pavement markings must be unidentifiable as pavement markings under day or night, wet or dry conditions.

Do not over-paint markings with black paint or bituminous solutions. This treatment has proven unsatisfactory because the original lines eventually reappear as the overlying material wears away. In addition, lines covered in this manner may still be visible under wet conditions or low angle illumination (headlights) conditions.

Guideposts

Guideposts are classified as guide markings rather than required warning devices. Guidepost type designations are noted on Standard Plan H-1. Guidepost placement guidelines are noted in Figure 1.

Barrier delineation is used in areas with guardrail or concrete barrier where guideposts are required by other roadway conditions. The spacing of barrier delineators for these applications is the same as the spacing noted for guideposts. Promptly replace damaged or missing guideposts and barrier delineators.

Traffic Barriers and Impact Attenuators

Traffic barriers such as beam guardrail, cable barrier, and concrete barrier are used to protect vehicles from hazards within the Design Clear Zone (as defined in Chapter 2) that cannot be removed or otherwise relocated. Hazards may be a single point, such as a bridge pier, or an extensive area, such as steep embankments. Elements of traffic barriers include the standard run of barrier, terminals or anchors for the treatment of the ends, and transitions for connecting to stiffer barriers.

Maintain records with descriptions of observations and repairs.

Maintenance

Barriers must be properly maintained to ensure that they will perform properly when struck by errant vehicles. Keep the area under and around barriers clean and free of vegetation and debris. Do not allow objects that could become projectiles to be placed on top of barriers.

Inspection

Inspect barriers periodically, either by visual drive-by or by physical inspections.

Inspect for:

- The overall condition of the barrier.
- Proper interconnection of units.
- Proper installation of anchor cables and connecting pins.
- Tightness of blocks and fasteners.
- Proper overlapping of beam guardrail.
- Secure attachment of beam guardrail.

Repair

Repair damaged roadside barriers promptly. A response within two weeks is desired unless higher priorities preempt action. Once a damaged barrier has been identified, determine if the barriers will be repaired, replaced, or removed.

Removal of a barrier may be the best solution but this requires an evaluation of the requirement for a barrier. In some instances the need for the barrier can be eliminated (by flattening slopes or removal of a fixed object for example). Contact the Region Traffic Engineer for guidance on evaluating the requirement for a

barrier. The following guidance is provided for evaluating the requirement to upgrade a barrier:

Standard Run of Barrier

The standard run of barrier is the majority of the barrier run. It includes all of the barrier except the terminals and transition sections. Barriers have evolved over many years and as a result there are systems on Washington state highways that no longer meet current design standards.

Examples of non-standard barriers include:

- W-beam guardrail with 12'-6" post spacing and no block outs.
- W-beam guardrail on concrete posts.
- Cable barrier on wood or concrete posts.
- Half moon or C shape rail element.

If damage to these barriers requires the reconstruction of a significant portion of the run, consider upgrading the entire run to current standards. For minor repairs, upgrade the damaged portion of w-beam barriers to current standards (post spacing, block outs, etc.). Minor repairs to non-standard cable, half moon, or C shaped rails can be repaired in kind as upgrading may not be practical.

Terminals and Anchors

A guardrail anchor is required at the ends of a standard run of guardrail to develop its tensile strength throughout its length. In addition, when the end of any barrier is subject to head-on impacts, a crash worthy terminal is required. Guardrail anchorage may be provided as part of the terminal, as a connection to a rigid structure, or by an anchor whose only purpose is to strengthen the run (Type 4 and 7 anchors).

Many different terminal designs have been used on Washington state highways. Upgrade damaged guardrail ends that do not have a crash worthy design.

Common features of non-crash worthy designs are as follows:

- No cable anchor.
- A cable anchored into concrete in front of the first post.
- Second post not breakaway (CRT).
- Design A end section (Design C end sections are acceptable to be left in place).
- Beam guardrail on both sides of the posts (two sided).

A common terminal that was used on Washington state highways is the Breakaway Cable Terminal (BCT). These terminals included a Type 1 anchor and a parabolic flare that offset the end 4 feet from the tangent run of guardrail. BCTs that have at least a four foot offset may be repaired in kind unless total reconstruction (replacement of the anchor) is required. Upgrade damaged BCTs with less than a 3 feet offset.

If a BCT is to be repaired, no washers can be permitted on posts 2 through 7.

When upgrading to current standards it may be possible to extend the run to a location where the end is less likely to be struck or where it can be buried in a back slope. When burying the end is not possible, consider a flared terminal as shown on Standard Plan C-4b or a non-flared terminal as shown on Standard Plan C-4e. These terminals are proprietary devices (they can only be manufactured by a licensed company) and the specific details are not shown on the standard plan. The manufacturers drawings that are used in Washington can be obtained from the manufacturer or downloaded from the Internet.

<http://www.wsdot.wa.gov/eesc/design/designstandards/>

Transitions

Transitions are used to stiffen a system such as w-beam guardrail before a more rigid barrier such as a bridge rail. Stiffening is accomplished by nesting the rail elements, using bigger posts and reducing the post spacing. The transitions that are currently used are shown in the Standard Plans.

If no transition is in place, upgrade a damaged rail by installing a transition as follows:

Connection	Transition Type Installation
Safety shaped bridge rail	Type 1 transition with a B connection
Connection to a bridge rail with a parapet that is less than 20 inches	Type 2 transition with a B or C connection (depending on the width of the curb)
Connecting to unrestrained pre-cast concrete barrier	Type 3 transition with an A connection
Unsure of the proper transition	Contact the regional Traffic Office

Sometimes damage to a transition is minor, not requiring the replacement of all of the posts. In these situations, existing transitions that have a w-beam rail element can be upgraded by adding an additional (nested) rail element. Upgrading the connection is not required for minor repairs.

Impact Attenuators

Impact attenuators can be used as an end treatment for barriers or to prevent errant vehicles from impacting other fixed objects. Keep records of impact attenuators in use: brand, an illustrated layout showing parts order numbers, module locations and weights, and a photograph of the installation.

Maintenance

Replace and repair impact attenuators in accordance with the manufacturer's recommendations. Check for proper restraining cable tightness, anchor bolt tightness, diaphragm and hardware in good condition, and fender panels securely in place.

Inspect sand-filled barrels to ensure lids are firmly in place and not dented. Make sure there is no moisture inside the modules, no damage or visible cracks in the outer shell. Check that each barrel is filled with the correct amount of dry sand or dry pea gravel. (See manufacturer's specifications.)

If the sand is found to contain moisture, mix salt with the sand at a rate of 10 percent to 20 percent (by volume) to prevent freezing. Some sand may need to be discarded before adding the salt to prevent overfilling the barrel.

Replace damaged water cell units. If one is to be left in place, check for leakage.

Islands

Islands must be properly maintained to provide protection of motorists and pedestrians. Keep island passageways clear of debris. Periodically repaint outlines of islands at least once a year. Replace missing or damaged raised pavement markers when more than three consecutive markers are missing.

Displaced or missing raised curb must be repositioned or replaced. Paint raised curb as directed by the Regional Traffic Engineer.

Transit Vehicle Stop Zones Maintenance

Transit stops along state highways outside cities are maintained by the state. These locations should be kept free of debris, potholes and other obstacles that could cause tripping. The responsibility for maintaining transit stops on state highways inside cities is covered in the agreement discussed in the Traffic Manual's transit vehicle stop zone guidelines. An inventory of transit stops is available at the Regional Traffic Office.

General

All electrical systems require periodic maintenance in addition to non-scheduled maintenance caused by unpredictable events such as storms, accidents, and equipment failure. The intent of periodic maintenance is to keep the system operating at an acceptable level of service to the public.

Certain maintenance activities are common to all systems, regardless of type. These activities should always be performed on the cycle applicable for the system. These activities are defined as follows:

Wiring and Connection Maintenance

- Clean conductors, terminals, and connectors of all corrosion.
- Tighten terminals and connectors including breaker, transformer, and contactor connectors.
- Check the equipment grounding system including conduit end bushing connections, bonds, equipment grounding conductors, enclosure grounding connections, and pole grounding connections.
- Check the grounding electrode, grounding electrode conductor, and associated connections.
- Check conductor insulation for damage, and repair if necessary.
- Replace deteriorated or missing conductor and terminal identification markings.
- Reference Standard Specification 8-20.3(5), 8-20.3(8), 8-20.3(9), and Standard Plan J-9a.

Enclosure Maintenance

- Clean enclosure inside and out.
- Repair corroded surfaces, fasteners, and anchor bolts.
- Lubricate lock, latch assembly, and hinges.
- Check door gaskets and base seals.
- Clean vent filter and replace if necessary.
- Clean drain hole.

Documentation

- Note all checks and repairs that are performed.
- Note major repairs that are required.

Changeable Message Sign Systems

- Observe operation.
- Lubricate hinges on varicom signs and check springs.
- Relamp bulb matrix signs.
- Spot-paint changeable message sign lamp visors, sunscreen, and background, where necessary.
- Clean legend on disk signs.

Drain Pump Systems

- Check pump pit for water.
- Check water pipes for corrosion.
- Clean sump.
- Check high water alarm.
- Test pump and lubricate.
- Check heater and thermostat.

Gate and Barrier Systems

Minor

- Check relays, test switch, and limit switches.
- Operate per instructions and check all moving parts.

Major

- Check relays, test switch, and limit switches.
- Operate per instructions and check all moving parts.
- Clean gate surface.
- Tighten all mechanical connections.
- Lubricate shear pins, bull gear, and shaft.
- Check transmission level.
- Check collars.
- Check brake.
- Check heater.
- Remove flash guards and inspect.

Intersection Control Beacons (Includes Hazard Beacons)

- Check flasher assembly.
- Relamp. (Reference Standard Specification 9-29.16(2)A.)
- Clean lens and reflector.
- Spot-paint deteriorated areas of visor and head.
- Check signal mounting.
- Check signal supports.
- Check vertical clearance (16'6" minimum for overhead locations).

Illumination Systems

Roadway Illumination Systems

- Relamp.
- Clean reflector and refractor.
- Check fusing in pole base (Standard Specification 9-29.10).
- Check bolt torque on slip bases.
- Check if conductors are secured on breakaway base installations at adjacent junction boxes (Standard Plan 1e).

- Replace damaged or missing pole identification markings.
- Check junction boxes, adjust if necessary.

Sign Lighting Systems

- Relamp.
- Clean reflector and refractor.
- Check support mountings.
- Check fusing.

Services

- Check photocell.
- Check timers.
- Check contactors.
- Megger test any illumination circuits.
- Replace deteriorated or missing service identification markings.
- Check control transformer on 480 volt services.
- Check test switch.
- Check heater and thermostat.

Signal Systems

(Includes traffic signal systems, reverse lane signals, emergency vehicle signals, data accumulator stations, and ramp meter signals.)

Vehicle Detection Systems

- Check amplifier operation by observing traffic and display panel indicators.
- Check loops and repair if required (Standard Plan 8a).
- Megger test loop circuits and record.

Pedestrian Detection and Display System

- Check all buttons for operation.
- Replace damaged buttons and/or signs (Standard Plan J-5a).
- Clean lens and reflector.
- Relamp incandescent heads (Standard Specification 9-29.20).
- Repair neon grid assemblies as required.
- Spot-paint mounting brackets as required.

Vehicle Display Systems

- Relamp displays. (Standard Specifications 9-29.16(1)A and 9-29.16(2)A.)
- Clean lens and reflector.
- Spot-paint steel mounting brackets. Aluminum or bronze mountings will not require painting.
- Check mountings for wear and tightness.
- Check tether cable assemblies.
- Check seals on aerial junction boxes.

Electrical System Maintenance

- Check vertical clearance (16'6" minimum for overhead displays).
- Check signal supports, messenger cable connections, and back guys.
- Replace missing cable ties on span wire systems.
- Adjust junction boxes, replace missing or damaged lids.

Signal Control Systems

- Observe controller timing functions.
- Check load switches.
- Check display panel, replace burned out indicator lights.
- Check coordination and communication equipment.

Sprinkler Systems

- Cycle controller on 5 minute cycle.
- Check solenoids.
- Adjust junction boxes.

Television Systems

- Lubricate mounting assembly.
- Check operation.
- Remove camera and shop-test.

Right of Way Fences

Fencing is provided to discourage encroachment onto highway rights of way. Fencing on a controlled access highway is usually owned and maintained by the state while fencing on non-controlled access highways is normally owned and maintained by the abutting property owner. Questions regarding maintenance responsibilities of a given section of fence should be resolved by the Area Superintendent.

Road Approaches- General

No road approaches are allowed without WSDOT authorization. A road approach for private access requires a permit, available at region and area offices, which stipulate the conditions under which it is granted. Such conditions often include allowed width, turn radii, paving and culvert requirements, and specific location to ensure adequate sight distance. The permit holder is normally responsible for maintenance of the approach between the edge of pavement and the property line. If permit violations are identified, the Area Superintendent should be notified. There is a fee charged by WSDOT for new road approach permits. This is to cover the administrative cost of investigating, writing and reviewing the permit. The charge is \$50.00 for an individual single family approach and an additional \$50.00 for each added user of the same approach.

Typical Maintenance Responsibilities in Cities

Maintenance on streets may become complicated, depending on the type of installation. In accordance with RCW 47.24 and WAC 468-18-050, cities with a population greater than 22,500 have different requirements for some types of maintenance than do cities with a population less than 22,500. In general, the city or town is responsible for any portion of the facility beyond the curbs. If no curb is installed, the city or town's responsibility begins at the shoulder edge.

The following guidelines are designed to clearly identify typical maintenance responsibilities, as determined by statute, agreement, or policy, on city streets that are certified as part of a non-controlled access state highway route. They are general in nature and do not preclude WSDOT and individual cities from entering into agreements to address particular circumstances.

Table 1
City/State Maintenance Responsibilities for City Streets as
Part of the State Highway System

Maintenance Item	Population of Cities	
	Over 22,500	Under 22,500
Roadway Surface	State	State
Roadway Shoulders	State	State
Stability of cut and fill slopes	City	State
Sidewalks	City	City
Curbs	State	State
Parallel Roadside Ditches	City	City
Roadside Approach Culverts	City	City
Cross Culvert	City (3)	City (3)
Snow Plowing	See Note (4)	See Note (4)
Sanding and De-icing	City	City
Snow Removal	City	City
Sand Removal	City	City
Channelization	City(1)	City
Crosswalks	City (1)	State
Striping	City (1)	State
Directional Signs/Route Markers	State	State
Parking Signs	City	City
Regulatory Signs	City	State
Stop Signs- (Intersecting Streets)	City	State (7)
Signals	City	State
Guardrail, Concrete Barrier, Impact attenuators, etc.	State/City (2)	State/City (2)
Illumination	City (6)	City (6)
Street Cleaning	City	City
Street Sweeping	City	City
Vegetation	City	City

Maintenance Item	Population of Cities	
	Over 22,500	Under 22,500
Noxious Weeds	City (5)	City (5)
R/W Encroachments	City	City
R/W Cleanup	City	City
Utility Franchises	City	City
Underground Facilities	City	City

NOTES

1. As a part of state reconstruction/resurfacing projects the state will replace in kind at no cost to the local agency only pavement markings that are damaged or removed as a result of the reconstruction or resurfacing project. This does not apply to durable markings that have exceeded their useful life. Installation of higher quality pavement markings will be at the expense of the city. Early communication and plan reviews between WSDOT and the city is essential to enable local agencies to avoid installation of pavement markings, especially the more durable markings prior to construction.
2. Traffic barriers installed on state highways in areas without curbs shall be maintained by WSDOT. Traffic barriers installed beyond the curb shall be maintained by the cities. Curb in the context of RCW 47.24.020(2) refers to a standard curb and gutter and not to be extruded curb such as those placed on fill sections for erosion control. Guardrail, concrete barriers, impact attenuators and similar devices are all considered to be traffic barriers.
3. Within all cities, regardless of population, the state shall solely maintain the structural integrity of box culverts, multiplates and individual culverts greater than 60 inches in width that are within rights of way and are not part of an enclosed drainage system. These are the size appropriate to identify natural stream flows. Those structures that are less than 60 inches in width will be maintained by the cities. Cities shall maintain all other parallel roadside ditches and road approach culverts. Grass-lined swales constructed by the state solely for state highway runoff will be maintained by WSDOT.
4. RCW 47.24.020(6) provides that the cities have responsibility for snow and ice removal within their jurisdiction and that the state shall, when necessary, plow the snow on the roadway. The meaning of "when necessary" is that the state will plow snow, with city concurrence, on the traveled lane of the state highway on the way through the cities not having adequate snow plowing equipment.
5. RCW 47.24.020(2) states that the city or town shall exercise full responsibility for and control over any such street beyond the curbs and if no curb is installed, beyond that portion of the highway used for highway purposes and, thus, are responsible for noxious weed control.
6. The state has responsibility for maintenance of illumination systems within fully access controlled areas. In addition, the state may, with city concurrence, maintain and operate luminaires at locations where the electrical service powers electrical equipment under both state and city responsibility.
7. WSDOT, with city concurrence, may install stop signs and posts to the city's standards or may contract with the city to have them perform these installations.

**Table 2
City/State Maintenance Responsibilities For Bridges That Convey Non-Limited Access
State Highways That Are Also City Streets
(Unless Otherwise Covered Under A Separate Agreement)**

Maintenance Item	Population Cities	
	Over 22,500	Under 22,500
Structural Related Bridge Maintenance	State	State
Bridge Condition Inspections	State	State
L/C Overlays on Structures	State	State
Bridge Deck Membranes	State	State
Structural Asphalt Overlay on Bridge	State	State
Non-Structural Asphalt Overlay on Bridge	State	State
Approach Slab	State	State
Bridge Deck Joints	State	State
Bridge Railings	State	State
Graffiti	City	City
Deck Sweeping	City	City
Bridge Drains/Drainage	City	State
Striping	City	State
Illumination	City (2)	City (2)
Snow Plowing	See Note (1)	See Note (1)
Snow Removal	City	City

NOTES

1. RCW 47.24.020(6) provides that the cities have responsibility for snow and ice removal within their jurisdiction and that the state shall, when necessary, plow the snow on the roadway. The meaning of “when necessary” is that the state will plow snow, with city concurrence, on the traveled lane of the state highway on the way through the cities not having adequate snow plowing equipment.
2. The state has responsibility for maintenance of illumination systems within fully access controlled areas. In addition, the state may, with city concurrence, maintain and operate luminaires at locations where the electrical service powers electrical equipment under both state and city responsibility.

Table 3
State Owned Bridges That Convey City or County Traffic Over a Limited or Non-Limited
Access Highway Corridor
(Unless Otherwise Covered Under A Separate Agreement)

Maintenance Item	City/State	City/State
Structural Related Bridge Maintenance	State	State
Bridge Condition Inspections	State	State
L/C Overlays on Structures	State	State
Bridge Deck Membranes	State	State
Structural Asphalt Overlay on Bridge	State	State
Non-Structural Asphalt Overlay on Bridge	City(1)	County (1)
Approach Slab	City (2)	County (2)
Bridge Deck Joints	See Note (3)	See Note (3)
Bridge Railing	State	State
Graffiti	City	County
Deck Sweeping	City	County
Bridge Drains/Drainage	City	County
Striping	City	County
Illumination	City	County
Snow Plowing	City	County
Snow Removal	City	County

NOTES

1. Cities/counties should obtain the states concurrence prior to performing non-structural asphalt deck overlays on state owned structures.
2. Approach slab maintenance is the primary responsibility of the city/county. In the case where the state performs a structural overlay on the bridge deck, the state may extend the overlay onto the approach slab to provide for a smooth transition on or off the bridge.
3. Joints located on the bridge deck are the responsibility of the state. Back of pavement seat joint repairs are the responsibility of the city/county unless they affect the structural integrity of the bridge.

The State has full maintenance responsibility for bridges conveying a State Route or Interstate traffic in a limited access corridor (unless otherwise covered under a separate agreement).

Maintenance Yards

All maintenance yards are to be kept in a neat, clean, and orderly condition. All buildings are to be kept in good repair, inside and out, and are to be repainted when necessary.

Truck sheds are to be kept clean of debris and free from fire hazards. Gasoline and other highly flammable materials should not be stored in buildings where trucks or equipment are stored. Oily rags should be kept in metal containers.

Materials and supplies are to be stored in an orderly manner and an inventory is to be kept of all materials and supplies on hand. All buildings and yards are to be kept locked when not occupied by responsible personnel.

Hazardous wastes i.e. (solvent contaminated rags, methyl methacrylate wastes, and paint residues) are to be placed in proper containers, labeled with a yellow hazardous waste label and disposed of properly within (90) days.

Stockpile Sites

Stockpile sites are to be cleared of all vegetation, trees, brush, rocks, or other debris, and a uniform ground surface is prepared prior to depositing stockpile material. The site chosen should attempt to minimize visual impact, especially in urban areas. Stockpiles are to be constructed in a neat and regular shape, occupying as small an area as practical, and accessible for loading material onto trucks without obstructing the highway. Stockpiles are built up in layers. Plank runways are required for operating trucks on stockpiles where there is danger of tracking dirt or other foreign matter onto the material.

Signs that identify the material as state property should be placed at each stockpile.

Sites where materials are stockpiled year-round or for a considerable period of time should be fenced with signs placed along the fence line identifying the site as state property and the gates kept locked.

Stockpiles should periodically be inspected for vegetation growth, which should be removed.

Maintenance personnel should inspect stockpiles regularly and be on the alert against any removal of materials by unauthorized persons. The inspection should also note potential storm water impacts off-site and corrections should be made as appropriate.

Material used by state forces is to be promptly charged out and reported to the area office. Excessive amounts of materials should not be allowed to accumulate in stockpile sites. If use of stockpiled materials is not anticipated, the area office should be notified so the material can be declared surplus.

Materials from State Quarries or Pits

Materials produced or manufactured in state-owned or leased pits or quarries may not be sold, or otherwise disposed of, to private individuals or concerns.

Counties and cities or other governmental agencies may participate by having their requirements included in the state's crushing contract, with proper financial arrangements. It is the state's policy to assist other governmental agencies in need of small quantities of crushed rock by selling them material from existing stockpiles at current inventory prices if the material can be spared.

When quarry or pit sites are obtained from the Department of Natural Resources, the material is to be used for state highway construction or maintenance, or by other approved public agencies. Notify the area office when material from such pits and quarries is used.

Ecology storm water permits are required at pits and quarries where aggregate is being mined or crushing operations are taking place. Contact the regional Environmental Office for information.

Procurement of Materials

Materials necessary for highway maintenance are generally available from the inventory of materials in stores. Stores should be checked well in advance of need, if possible, to help ensure that materials will be available when required. Materials not available must be purchased by personnel in the area or region office. This purchasing process can take weeks or even months for certain materials. Therefore, it is imperative to plan ahead whenever possible.

Material Specifications-General

It is WSDOT policy that all materials used by state forces to repair or reconstruct highway facilities and buildings conform within reason to the specifications adopted for like material in new construction.

Specifications are necessary to ensure that the department receives the quality of material required for the intended use, and to permit vendors to quote prices on an equal basis. It is difficult to dispute the quality of any material received if the original order did not explicitly define what was expected. It is imperative that maintenance personnel recognize the importance of specifications. There is a reason for a particular design, mix, formula, type, or dimension being specified. Good workmanship will not counteract the effects of the use of inferior material, material intended for another purpose, or material that would be adequate only under different conditions.

Disposal of Surplus Items

Equipment

If a crew determines that a piece of equipment is no longer needed or is no longer functional they should advise the superintendent or supervisor, providing information on needed repairs, problems, and future needs. This should be done to facilitate the decision on whether to transfer the equipment or dispose of it. A crew is charged for equipment even if it is not being used; therefore, it is important to be sure the equipment is necessary and operable.

Inventoried Items

If it is determined to scrap an article that is carried on an inventory, the region office should be provided with a description of the article, its inventory number, and a statement of its condition. Generally, requests for replacements, with any necessary justification, should accompany the recommendation for disposal.

Non-Inventoried Items

Non-inventoried items with potential trade-in or resale value may be declared surplus and turned in to the area office. Disposal of all items will be in accordance with the Disposal Manual, M 72-91.

Instructions for Radio Operation

General Technique

A standard radio operating procedure has been adopted by WSDOT to promote efficient use of radio facilities. All personnel have been assigned identifying numbers that are used when calling or referring to these units. The first digit identifies the district in which the unit is located, the second digit identifies the division, and the third and fourth digits identify the person. The name of the location of the base station in lieu of the base station number is preferred.

When the channel is clear, a calling operator may initiate a call by stating which number the operator is calling and identifying who is calling. Example: 1755 wishes to contact 175, 1755 would transmit - "175 from 1755." 1755 then waits for a reply. Don't repeat a call more than twice if you are not answered. If you are not acknowledged after two calls, sign off by transmitting your call number and wait at least two minutes before repeating a call. A called person should acknowledge a call by answering his own number. As in earlier stated example, 175 would acknowledge by transmitting simply - "175." If you are unsure of your call number or of the number of the person that you are calling, it is acceptable to use names.

Helpful Reminders

1. Emergency or urgent calls take priority over routine traffic. Therefore, all messages should be broken occasionally to permit another station to interrupt if there is an emergency.
2. At all times keep messages as brief, professional, and simple as possible.
3. Speak into the microphone in a normal tone of voice. Speak as clearly as possible. This is especially important when relaying technical information that the receiver may be unfamiliar with.

4. When receiving numbers in a transmission, the unit receiving should confirm the numbers with the transmitting unit.
5. Before beginning a transmission, listen for radio transmissions already in progress to avoid interrupting any other traffic.
6. Before beginning a transmission, hold the “talk switch” down for a short period (approximately a second).
7. You cannot receive radio traffic while the “talk switch” is down. Be sure to release it after completing your traffic and waiting for the reply.

For more complete instructions, refer to the WSDOT/ Highway Division Standard Operating Procedure Manual, M 58-01 Revised 1984.

Reference: Directive D 58-03.

Work Scheduling and Reporting

The previous sections of this manual were directed at specific maintenance activities. This section briefly covers the need to budget, plan, and report those activities. Since procedures change and various district policies vary, details for these processes are not included. The basic principles, however, will remain the same.

Budget

A new budgetary biennium begins on July 1 of every odd-numbered year. At this time the department begins to spend an appropriation of money that has been established by the legislature. A portion of these funds goes to Maintenance and Operations. In exchange for the biennial appropriation, the department commits to providing a certain, statewide level of service (LOS) for each of the forty activities identified in the Maintenance Accountability Process (MAP). Each region receives its share of these funds. The Regional Maintenance Engineer is responsible for seeing that each Area and Section office receives the appropriate share of the Region’s allocation in order to meet the LOS commitments made to the legislature. Specific planning is necessary to determine anticipated work activities and their fund requirements. The key word in this budget plan is “anticipated.” It is expected that actual work will not exactly match “anticipated” work. However, most work is expected and the budget plan is the basis for changes in the number of employees, equipment, and materials to accomplish the work.

By state law, units within the department may not overrun their budgets. Supervisors should be notified if budget problems begin to arise.

Scheduling

Throughout the biennium, supervisory personnel must have one eye on the work to be done and one eye on the budget. To ensure that the most important jobs are accomplished within the budget limits, the biennial budget plan must be refined into a work plan for each month’s activities. This enables coordination of materials and equipment availability with the work having the greatest priority for that month. Consistent with that monthly plan, Supervisors prepare a daily plan of specific work assignments for the upcoming week. This daily plan will not only recognize the priority items addressed in the monthly plan, but will also be adapted to fit current weather conditions, unexpected events, employee absences, equipment

Miscellaneous

breakdowns, etc. This is the backbone of good management and alerts all employees of the following day's activity so they can make proper preparation and wear proper clothing.

Reporting

The requirement to report what was accomplished in a day, by whom, and with what equipment and materials is often viewed in the field as relatively unimportant. But even though this reporting may seem excessive, it is the basis for budgeting and planning. Without accurate data on what work is actually done, it is impossible to properly prepare the next budget. And if the budget is unrealistic, planning will suffer and employees, equipment, or materials may be sent to the wrong location. Supervisory personnel should always encourage accurate reporting.

Environmental Sensitivity

Maintenance is WSDOT's most visible activity with respect to environmental consequences. Painting, sanding, anti-icing, herbicide application, mowing and brush control, landscaping, and maintaining drainage are activities that can raise environmental objections. All material handling can have environmental safety implications for our employees and the general public. Environmental, health and safety issues are being addressed through an education and training program provided by Headquarters.

Acronyms and Abbreviations

AAH-	Adopt a Highway
ACP-	Asphaltic Concrete Pavement
BMP-	Best Management Practices
BST-	Bituminous Surface Treatment
DOE-	Department of Ecology
HPA-	Hydraulic Project Approval
IVM-	Integrated Vegetation Management
LOS-	Level of Service
MAP-	Maintenance Accountability Process
MDT-	Measuring Distributor Tank
MUTCD-	Manual on Uniform Traffic Control Devices
PCC-	Portland Cement Concrete
PDA-	Preliminary Damage Assessment
PTO-	Power Take Off
RCP-	Roadside Classification Plan
RPM-	Raised Pavement Marker
RWIS-	Roadway Weather Information System
VMS-	Variable Message Signs
WDFW-	Washington State Department of Fish & Wildlife
WSDA-	Washington State Department of Agriculture
WSDOT-	Washington State Department of Transportation
WSP-	Washington State Patrol

City Streets as Part of State Highways

Guidelines reached by the Washington State Department of Transportation and the Association of Washington Cities on the interpretation of selected topics of RCW 47.24 and figures of WAC 486-18-050 for the construction, operations and maintenance responsibilities of WSDOT and cities for such streets

April 30, 1997

City Streets as Part of State Highways

The jurisdiction, control, and duty of the state and city or town for city streets that are a part of state highways is specified in RCW 47.24.020; however, the implementing WAC's, directives and manuals have been subject to interpretation. This report documents agreed upon guidelines that have been reached by the Washington State Department of Transportation (WSDOT) and the Association of Washington Cities (AWC) on the interpretation of construction, operations and maintenance responsibilities of WSDOT and cities for such city streets.

These agreed upon guidelines are derived from:

- The draft Task Force Report on City Streets As Part Of State Highway.
- Response to the legislative change that increased the 15,000 city population threshold to a 22,500 population threshold for state versus city responsibilities for certain maintenance responsibilities contained in RCW 47.24.
- Additional discussions by the Department, AWC and several cities on the interpretation of state versus local agency maintenance responsibilities that are illustrated in figures contained in WAC 468-18-050 and on other maintenance responsibilities for city streets that are part of state highways.

These guidelines are designed to facilitate the allocation of maintenance responsibilities between the WSDOT and Washington Cities pursuant to RCW 47.24. The guidelines of this report are not intended to reflect past practices but to apply to future practices. They are general in nature and do not preclude the WSDOT and individual cities from entering into agreements to address particular circumstances.

These agreed upon guidelines will be incorporated in WSDOT manuals and related guidance for maintenance, operations, and construction activities. AWC will distribute copies of this report to their members.

Agreed Upon Guidelines

The agreed upon guidelines of State and city responsibilities for city streets that are part of state highways are contained in the following tables:

- Table 1, City/State Maintenance Responsibilities For City Streets As Part Of The State Highway System
- Table 2, City/State Maintenance Responsibilities Of Bridges That Convey Non-Limited Access State Highways That Are Also City Streets (Unless Otherwise Covered Under A Separate Agreement)
- Table 3, State Owned Bridges That Convey City Or County Traffic Over A Limited Access Or Non-Limited Access Highway Corridor (Does Not Apply To City Or County Owned Bridges)

The following is an explanation of selected items of the above tables that are related to specific sections of RCW 47.24 and to WAC 468-18-050:

1. Guardrail (Barriers) Maintenance

Background: RCW 47.24.020(2) states that “The city or town shall exercise full responsibility for and control over any such street beyond the curbs and if no curb is installed, beyond that portion of the highway used for highway purposes.” The statement “...used for highway purposes...” has led to differing interpretations of WSDOT and local agency responsibilities for the maintenance of guardrail.

Agreed Upon Guideline: Traffic barriers installed on state highways in areas without curbs shall be maintained by the WSDOT. Traffic barriers installed beyond the curb shall be maintained by the cities. Curb in the context of RCW 47.24.020(2) refers to a standard curb and gutter and not to extruded curb such as those placed on fill sections for erosion control. Guardrail, concrete barriers, impact attenuators and similar devices are all considered to be traffic barriers.

2. Parallel Ditches and Cross Culverts

Background: The issue is clarification of what is meant by the RCW 47.24.020(2) statement “...for highway purposes...” for use in interpreting responsibilities of WSDOT and local agencies for maintenance of parallel ditches and cross culverts. Also at issue is responsibility for grass lined swale construction for water treatment purposes as compared to a ditch solely for drainage purpose. In addition a distinction needs to be made between cross culverts related to streams and maintaining natural flows as opposed to those constructed for storm drainage.

Agreed Upon Guideline: Within all cities, regardless of population, the state shall solely maintain the structural integrity of box culverts, multiplates and individual culverts greater than 60 inches in width that are within rights of way and are not part of an enclosed drainage system. These are the size appropriate to identify natural stream flows. These structures that are less than 60 inches in width will be maintained by the cities. Cities shall maintain all other parallel roadside ditches and road approach culverts. Grass-lined swales constructed by the state solely for state highway runoff will be maintained by the WSDOT.

3. Betterments - Pavement Markings

Background: RCW 47.24.020(13) provides that cities and towns having a population greater than 22,500 are responsible to install, maintain, operate and control all traffic control devices. This has been interpreted to mean that the city or town must replace pavement markings and similar devices when a street is resurfaced (i.e., these markings are not included in the project costs). The issue is that a WSDOT project may destroy very recently installed pavement markings that, especially if they are durable markings (e.g., thermoplastic, raised pavement markers, etc.), involve expense to the city. The cities recommend that in-kind replacement of these markings be a part of the project costs.

Agreed Upon Guideline: As a part of State reconstruction/resurfacing projects the State will replace in-kind at no cost to the local agency only pavement markings that are damaged or removed as a result of the reconstruction or resurfacing project. This does not apply to durable pavement markings that

have exceeded their useful life. Installation of higher quality pavement markings will be at the expense of the city.

Early communication and plan reviews between WSDOT and the city is essential to enable local agencies to avoid installation of pavement markings, especially the more durable markings, shortly before the construction activity takes place.

4. Snow Plowing

Background: At issue is the meaning of the phrase in RCW 47.24.020(6) that states "...except that the state shall when necessary plow the snow on the roadway." This statute states that the city or town, at its expense, is responsible for snow removal. The meaning of "when necessary" and responsibility of snow plowing versus snow removal needed clarification.

Agreed Upon Guideline: RCW 47.24.020(6) provides that the cities have responsibility for snow removal within their jurisdiction and that the State shall, when necessary, plow the snow on the roadway. The meaning of "when necessary" is that the State will plow snow, with city concurrence, on the traveled lane of the state highway on the way through the cities not having adequate snow plowing equipment.

Table 1
City/State Maintenance Responsibilities For City Streets As Part Of The State Highway System

Maintenance Item	Cities Over 22,500	Cities Under 22,500
Roadway Surface	State	State
Roadway Shoulders	State	State
Stability of Cut & Fill Slopes	City	State
Sidewalks	City	City
Curbs	State	State
Parallel Roadside Ditches	City	City
Road Approach Culverts	City	City
Cross Culverts	City (3)	City (3)
Snow Plowing	See Note (4)	See Note (4)
Sanding & De-icing	City	City
Snow Removal	City	City
Sand Removal	City	City
Channelization	City (1)	State
Crosswalks	City (1)	State
Striping	City (1)	State
Directional Signs/Route Markers	State	State
Parking Signs	City	City
Regulatory Signs	City	State
Stop Signs (Intersecting Signs)	City	State (7)
Signals	City	State
Guardrail, Concrete Barrier, Impact Attenuators, etc.	State/City (2)	State/City (2)
Illumination	City (6)	City (6)
Street Cleaning	City	City
Street Sweeping	City	City
Vegetation	City	City
Noxious Weeds	City (5)	City (5)
R/W Encroachments	City	City
R/W Cleanup	City	City
Utility Franchises	City	City
Underground Facilities	City	City

NOTES

1. As a part of State reconstruction/resurfacing projects the State will replace in-kind at no cost to the local agency only pavement markings that are damaged or removed as a result of the reconstruction or resurfacing project. This does not apply to durable markings that have exceeded their useful life. Installation of higher quality pavement markings will be at the expense of the city. Early communication and plan reviews between WSDOT and the city is essential to enable local agencies to avoid installation of pavement markings, especially the more durable markings, shortly before the construction activity takes place.
2. Traffic barriers installed on state highways in areas without curbs shall be maintained by the WSDOT. Traffic barriers installed beyond the curb shall be maintained by the cities. Curb in the context of RCW 47.24.020(2) refers to a standard curb and gutter and not to extruded curb such as those placed on fill sections for erosion control. Guardrail, concrete barriers, impact attenuators and similar devices are all considered to be traffic barriers.
3. Within all cities, regardless of population, the state shall solely maintain the structural integrity of box culverts, multiplates and individual culverts greater than 60 inches in width that are within rights of way and are not part of an enclosed drainage system. These are the size appropriate to identify natural stream flows. These structures that are less than 60 inches in width will be maintained by the cities. Cities shall maintain all other parallel roadside ditches and road approach culverts. Grass-lined swales constructed by the state solely for state highway runoff will be maintained by the WSDOT.
4. RCW 47.24.020 (6) provides that the cities have responsibility for snow removal within their jurisdiction and that the State shall, when necessary, plow the snow on the roadway. The meaning of “when necessary” is that the State will plow snow, with city concurrence, on the traveled lane of the state highway on the way through the cities not having adequate snow plowing equipment.
5. RCW 47.24.020(2) states the city or town shall exercise full responsibility for and control over any such street beyond the curbs and, if no curb is installed, beyond that portion of the highway used for highway purposes and, thus, are responsible for noxious weed control.
6. The state has responsibility for maintenance of illumination systems within fully access controlled areas. In addition, the State may, with city concurrence, maintain and operate luminaries at locations where the electrical service powers electrical equipment under both State and City responsibility.
7. WSDOT, with city concurrence, may install stop signs and posts to the city’s standards or may contract with the city to have them perform these installations.

Table 2
City/State Maintenance Responsibilities Of Bridges That Convey Non-Limited Access
State Highways That Are Also City Streets
(Unless Otherwise Covered Under A Separate Agreement)
(This table provides an interpretation of the figures of WAC 468-18-050)

Maintenance Item	Cities Over 22,500	Cities Under 22,500
Structural Related Bridge Maintenance	State	State
Bridge Condition Inspections	State	State
L/C Overlays on Structures	State	State
Bridge Deck Membranes	State	State
Structural Asphalt Overlay on Bridge	State	State
Approach Slab	State	State
Bridge Deck Joints	State	State
Bridge Railing	State	State
Graffiti	City	City
Deck Sweeping	City	City
Bridge Drains/Drainage	City	State
Striping	City	State
Illumination	City (2)	City (2)
Snow Plowing	See Note (1)	See Note (1)
Snow Removal	City	City

NOTES

1. RCW 47.24.020(6) provides that the cities have responsibility for snow removal within their jurisdiction and that the State shall, when necessary, plow the snow on the roadway. The meaning of "when necessary" is that the State will plow snow, with city concurrence, on the traveled lane of the state highway on the way through the cities not having adequate snow plowing equipment.
2. The state has responsibility for maintenance of illumination systems within fully access controlled areas. In addition, the State may, with city concurrence, maintain and operate luminaires at locations where the electrical service powers electrical equipment under both State and City responsibility.

Table 3
State Owned Bridges That Convey City Or County Traffic Over A Limited Access Or
Non-Limited Access Highway Corridor
(Does Not Apply To City Or County Owned Bridges)
(This table provides an interpretation of the figures of WAC 468-18-050)

Maintenance Item	City/State	County/State
Structural Related Bridge Maintenance	State	State
Bridge Condition Inspections	State	State
L/C Overlays on Structures	State	State
Bridge Deck Membranes	State	State
Structural Asphalt Overlay on Bridge	State	State
Non-Structural Asphalt Overlay on Bridge	City (1)	County (1)
Approach Slab	City (2)	County (2)
Bridge Deck Joints	See Note (3)	See Note (3)
Bridge Railing	State	State
Graffiti	City	County
Deck Sweeping	City	County
Bridge Drains/Drainage	City	County
Striping	City	County
Illumination	City	County
Snow Plowing	City	County
Snow Removal	City	County

NOTES

1. Cities/counties should obtain the states concurrence prior to performing non-structural asphalt deck overlays on state owned structures.
2. Approach slab maintenance is the primary responsibility of the city/county. In the case where the state performs a structural overlay on the bridge deck, the state may extend the overlay onto the approach slab to smooth traffic flow.
3. Joints located on the bridge deck are the responsibility of the state. Back of pavement seat joint repairs are the responsibility of the city/county unless they affect the structural integrity of the bridge.

The State has full maintenance responsibility for bridges conveying a State Route or Interstate traffic in a limited access corridor (unless otherwise covered under a separate agreement).

Attachments - Intersection Diagrams from WAC 468-18-050

GENERAL NOTES

		MINIMUM TAPER LENGTH (L) IN FEET							
		Posted Speed (mph)							
Lane Width (feet)		25	30	35	40	45	50	55	
	10		105	150	205	270	450	500	550
	11		115	165	225	295	495	550	605
12		125	180	245	320	540	600	660	

The maximum spacing between channelizing devices in a taper should be nearly equal in feet to the speed limit; the maximum spacing between channelizing devices used to separate traffic should be 2 times the speed limit.

All sign placement distances are \pm .

KEY:
 ■ ■ Channelizing devices

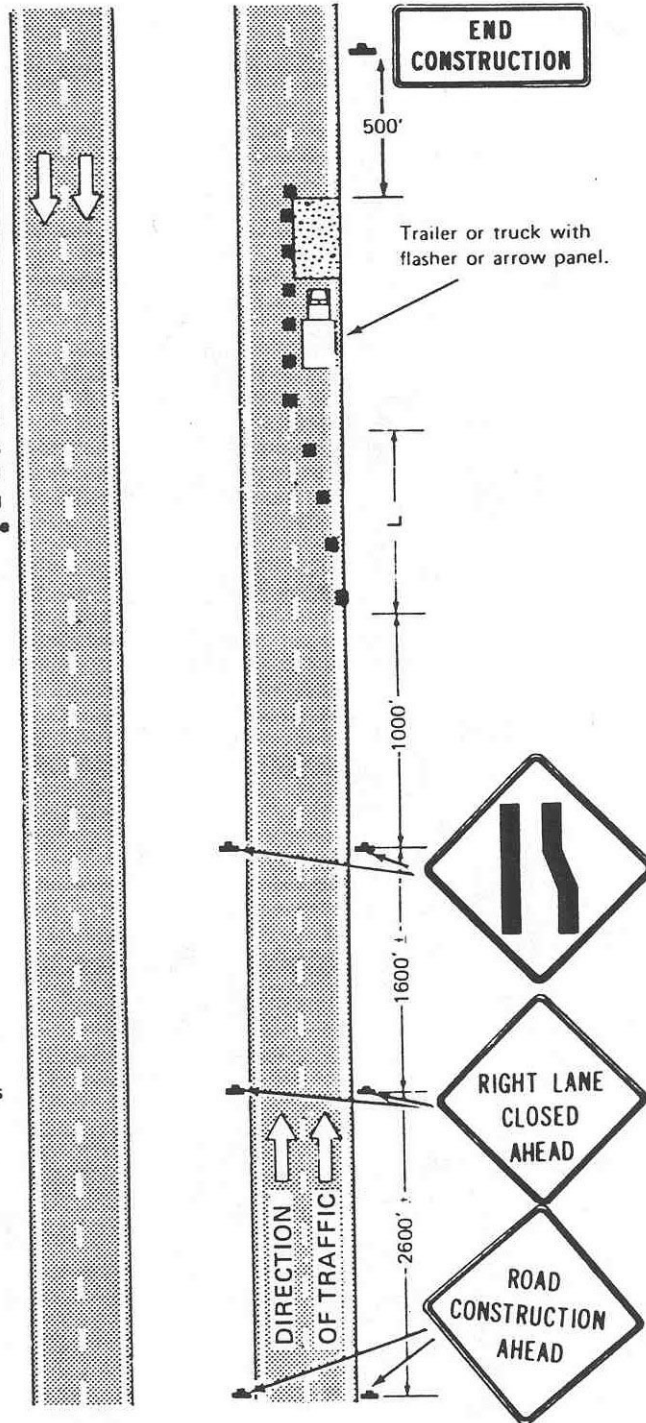

Typical application—daytime maintenance operations of short duration on a 4-lane divided roadway where half of roadway is closed.

Figure A1

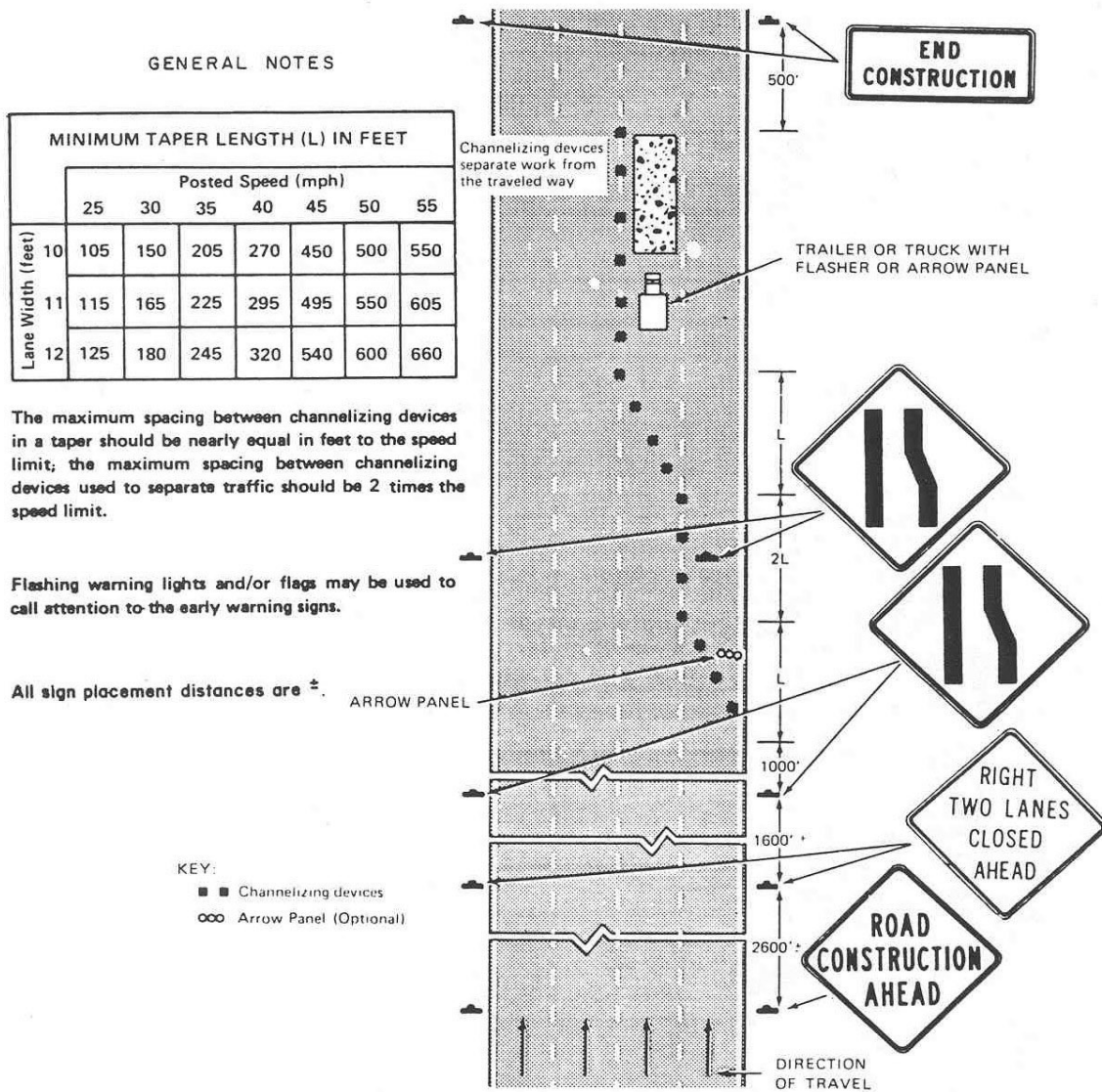

Typical application—closing multiple lanes of a multilane highway

Figure A2

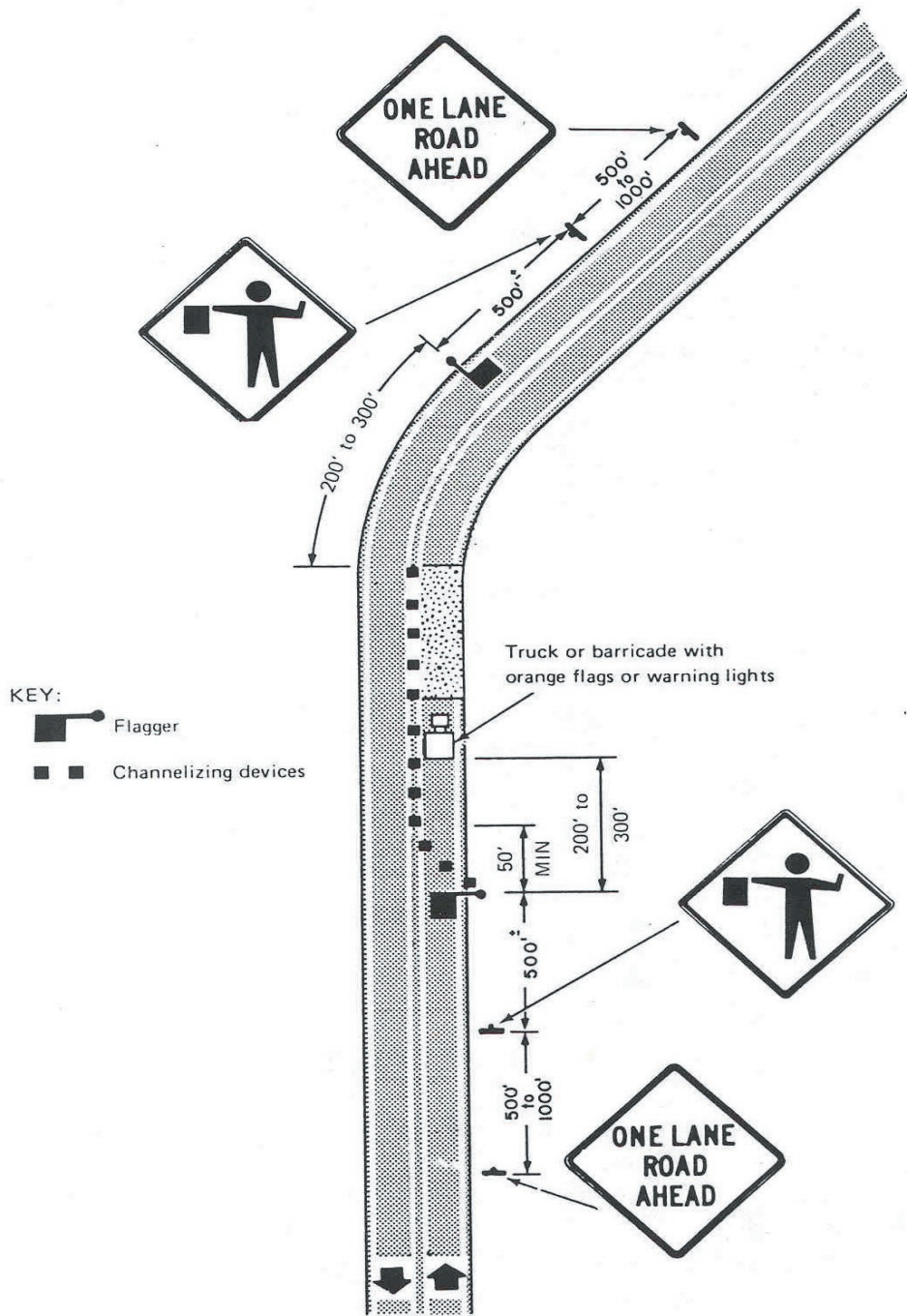

Typical application—daytime maintenance operations of short duration on a 2-lane roadway and flagging is provided.

Figure A3

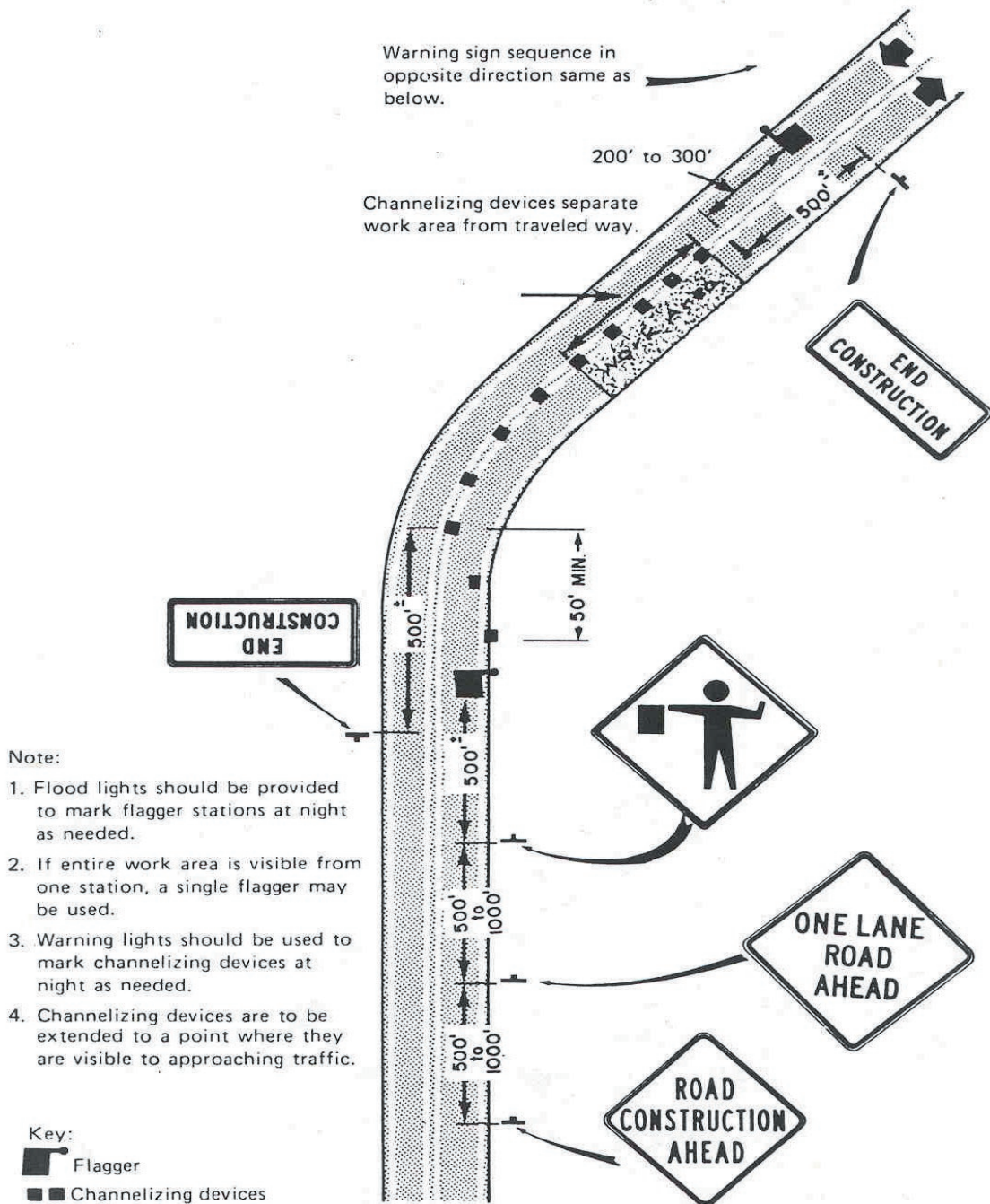

Typical applications of traffic control devices on 2-lane highway where one lane is closed and flagging is provided.

Figure A4

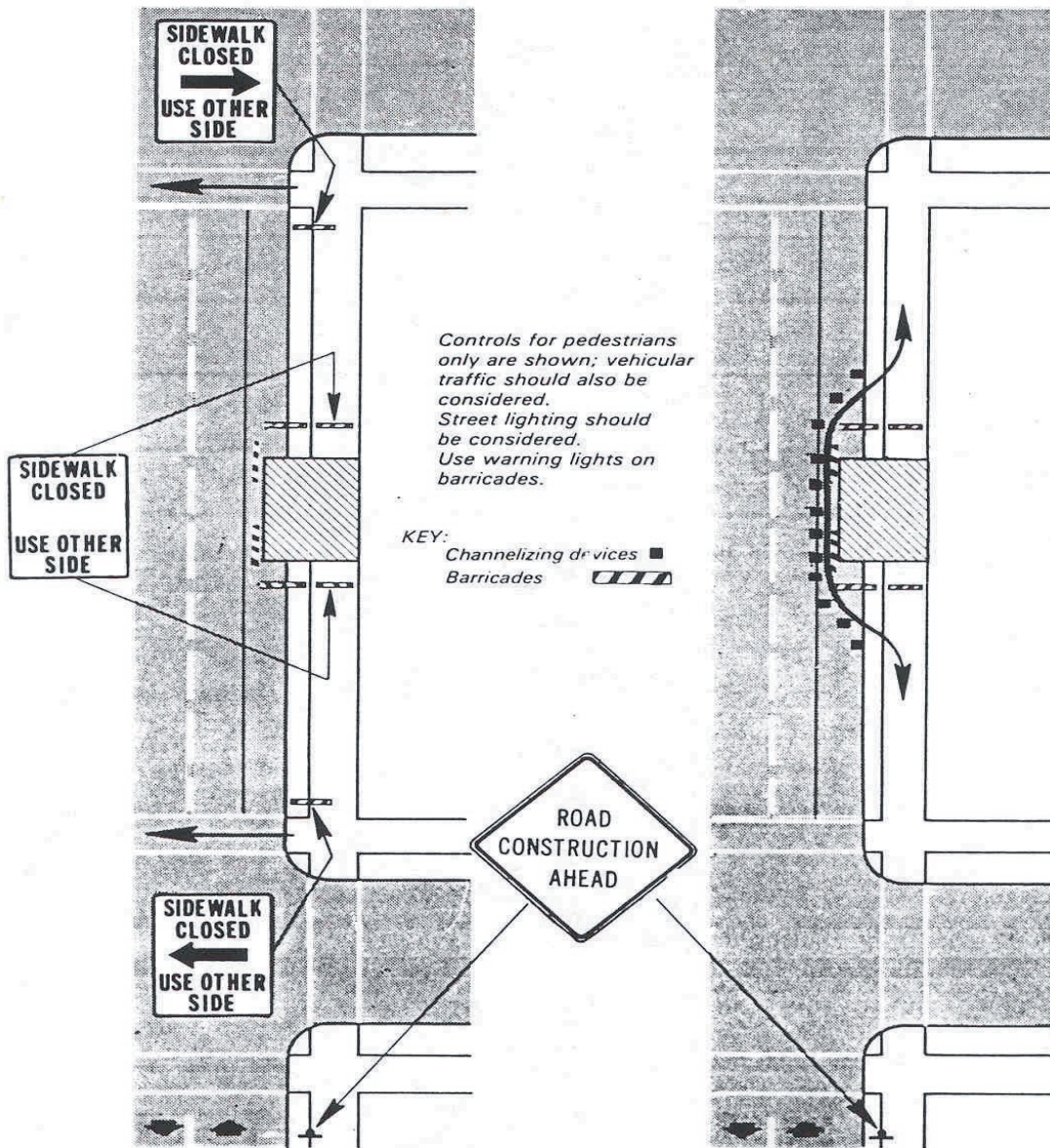

Typical applications—two methods for controlling pedestrian traffic by either directing pedestrians to another route or providing a walkway

Figure A5

Emergency Procedures Manual

M 3014
April 1999



Washington State Department of Transportation

Emergency Procedures Manual

M 3014
April 1999



Washington State Department of Transportation
WSDOT and FHWA



Persons with disabilities may request this information be prepared and supplied in alternate forms by calling the WSDOT ADA Accommodation Hotline collect (206) 389-2839. Persons with hearing impairments may access WA State Telecommunications Relay Service at TT 1-800-833-6388, Tele-Braille 1-800-833-6385, or Voice 1-800-833-6384, and ask to be connected to (360) 705-7097.

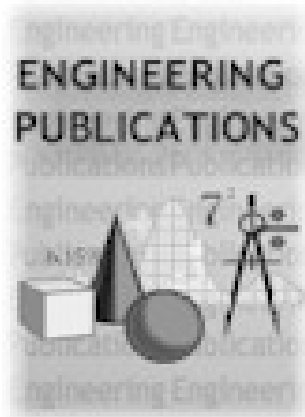

Engineering Publications

Washington State Department of Transportation
PO Box 47408
Olympia, WA 98504-7408
E-mail: lovem@wsdot.wa.gov

Phone: (360) 705-7430

Fax: (360) 705-6861

<http://www.wsdot.wa.gov/fasc/EngineeringPublications/>

Purpose

The purpose of this manual is to establish emergency operating procedures for Washington State Department of Transportation (WSDOT) employees to respond to, and recover from, emergencies/disasters that effect the operations of the department.

Supersession

This supersedes IL 4010.00 issued April 20, 1998.

RCW, WAC, and Directives

RCWs

RCW 47.28.030 — “Contracts-State Forces-Monetary Limits-Prequalification Rules”

RCW 47.28.035 — “Cost of Project, defined”

RCW 41.06.380 — “Purchasing services by contract not prohibited-Limitations”

RCW 47.28.050 — “Call for Bids”

RCW 47.28.70 — “Form of Bid-Data Required-Requirements-Refusal to Furnish Form-Appeal”

RCW 47.28.170 — “Emergency Protection and Restoration of Highways”

RCW 60.28.011 — “Retained Percentage”

Local Permits

Floodplain Development Permits

RCW 86.16 — “Floodplain Management Act”

Shoreline Management Permits

RCW 90.58 — “Shoreline Management Act of 1971”

WAC 173-26 — “State Master Program Approval/Amendment Procedures”

Critical Area Ordinances (CAO)

RCW 36.70A.172 — “Growth Management Act — Critical Areas — Designation and Protection — Best Available Science to be Used”

State Permits

Department of Ecology — Short Term Modifications to Water Quality Standards under RCW 90.48 are no longer issued. You must meet WQ standards.

Department of Ecology — Section 401 Water Quality Certification under 33 USC 1341

Federal Clean Water Act Section 401

RCW 90.48 — “Water Pollution Control”

WAC 173-225 — “Federal Water Pollution Control Act — Establishment of Implementation Procedures of Application for Certification”

Department of Ecology — Coastal Zone Management Certification

U.S. Coastal Zone Management Act, 16 U.S.C. 1451, et seq., and 15 CFR,
Parts 923-930

Department of Ecology — NPDES Construction Site

National Pollutant Discharge Elimination System (NPDES) Permit

RCW 90.48 — “Water Pollution Control”

WAC 173-224 — “Wastewater Discharge Permit Fees”

WAC 173-226 — “Waste Discharge General Permit Program”

Department of Ecology — NPDES Municipal Stormwater (SW) Discharge State
Waste Discharge Permit

RCW 90.48 — “Water Pollution Control”

RCW 90.52 — “Pollution Disclosure Act of 1971”

RCW 90.54 — “Water Resources Act of 1971”

WAC 173-216 — “State Waste Discharge Permit Program”

Department of Fish and Wildlife — Hydraulic Project Approval (HPA)

RCW 75.20 — “Construction Projects in State Waters”

WAC 220-110 — “Hydraulic Code Rules”

Federal Permits

US Army Corps of Engineers — Section 10 of the Rivers and Harbors Act of 1899
under 33 USC 403. Work or structures in or over navigable waters of the US will
require a Section 10 permit from the Corps of Engineers.

US Army Corps of Engineers — Section 404 Permit of the Clean Water Act under
33 USC 1344. The discharge of dredged or fill material into water of the US,
including wetlands requires a Section 404 permit from the Corps of Engineers. This
requirement covers the placement of material excavated or dredged from waters of
the US, mechanized landclearing, and the discharge of any material used for the
primary purpose of replacing an aquatic areas with dry land or of changing the
bottom elevation of the waterbody.

Endangered Species Act (ESA)

Section 7 and 9 of the Endangered Species Act of 1973, as amended

WACs

WAC 173-14 — “Permits for Developments on Shorelines of the State”

WAC 197-11 — “State Environmental Policy Act (SEPA) Rules”

Directives/Instructional Letters

IL 07-45 — “Emergency Declarations”

IL 27-02 — “Region Ad and Award . . . Construction Projects”

D 27-60 — “Federally Funded Highway Construction Project Closure Process”

M 72-80 — “Purchasing Manual”

Introduction

When an emergency occurs the region needs to determine if the emergency requires an “Emergency Declaration.”

An “Emergency Declaration” is required whenever it is necessary to utilize emergency contracting procedures” for work related to transportation facilities and to increase the limit for State Force repair work from \$50,000 to \$80,000.

If the event is large enough that federal “Emergency Relief” funding will be pursued the Region needs to contact FHWA in Olympia so that a Detailed Damage Assessment Form (DDIR) can be prepared.

The following is applicable to all divisions of the Department of Transportation.

Declaration of Emergency

The Declaration of Emergency authority is hereby delegated from the Secretary of Transportation to the Regional Administrators and the Assistant Secretaries of Aviation and Ferries for all work directly or indirectly related to transportation facilities. This also includes all work affecting property owned or used by their headquarters organization.

The Declaration of Emergency authority can be further delegated to the Maintenance Superintendent by the Regional Administrator or a designee of the Assistant Secretaries of Aviation and Ferries, when the preliminary repair estimate to provide the work does not exceed \$80,000 including sales tax, this also applies to property owned or used by a headquarters organization.

The Regional Administrators and/or the Assistant Secretaries for Aviation and Ferries are required to inform the Secretary of Transportation of all declared emergency projects. The Secretary of Transportation or designee is responsible for reporting all projects over \$200,000 to the Commission at the next regularly scheduled meeting or as soon as practical.

Each declared emergency will be recorded on DOT Form 540-021X (see Appendix 1). The form is to be signed by the declarer and sent to OSC Emergency Management by the next working day. For each declared emergency, a project title will be given and work order(s) will be established. The same project title should be utilized wherever possible throughout all subsequent work phases and communications concerning the emergency.

Procedures

<i>Action By</i>	<i>Action</i>
Maintenance Superintendent and Designee(s) for the Assistant Secretaries for Aviation and Ferries	<ol style="list-style-type: none">1. Prepare declaration of emergency using DOT Form 540-021X, emergency work under \$80,000 and related to transportation facilities2. Send Form to OSC Emergency Management Office by the next working day
Regional Administrator and Assistant Secretaries for Aviation and Ferries	<ol style="list-style-type: none">1. Prepare declaration of emergency using DOT Form 540-021X, emergency work over \$80,000 and related to transportation facilities2. Send Form to OSC Emergency Management Office by the next working day

Note: OSC Emergency Management Office will make distribution of the Emergency Declaration Form to the Transportation Commission Administration, Secretary of Transportation, OSC Communications and Public Involvement Office, Assistant Secretary for Finance and Administration, Assistant Secretary for TransAid, OSC Program Management, OSC Records Control, OSC State Maintenance Engineer, and to State Emergency Management (Military Department).

2:P:DP/EPM

Maintenance-Construction Work Definition

Ordinary Maintenance

There are two types of Maintenance work activities classified as “ordinary maintenance” — Normal Maintenance and Emergency Maintenance.

Accordingly, if the work is considered to be “ordinary maintenance” state forces may accomplish the work without being subject to the dollar limitations outlined in RCW 47.28.030 and 47.28.035. “Ordinary maintenance” is also exempt from the competitive bidding process.

Definition of the Two Types of Maintenance Activities

1. **Normal maintenance** — budgeted work, performed routinely on a scheduled basis. It is intended to maintain the highway facility/element so that it substantially retains its original intended use and function.

Examples include:

Sweeping and debris removal	Maintaining access control
Clean ditches, culverts, and catch basins	Drainage restoration
Correcting moderate slides and slope failures	Placing riprap
Vegetation management and litter pickup	Snow and ice control
Moderate bridge maintenance	Traffic control
Rest Area operation and maintenance	
Pavement patching, crack sealing, and moderate surface treatment	
Bridge maintenance such as debris removal, scour	
Restoration/replacement of traffic control devices	

2. **Emergency maintenance** — work activities are the same or similar to normal maintenance activities except that they are greater in magnitude and scope depending upon the nature and intensity of the emergency. This work is not budgeted and/or scheduled and is done on a routine basis. This includes work accomplished on a damaged highway facility/element that has substantially retained the intended functionality of its original design. It does not include construction of new roadway elements.

Examples include:

Erection, dismantling, and maintenance of a Bailey bridge
Establishment of detours and temporary minor structures
Emergency traffic control
Any work needed to protect and maintain the area affected by the emergency, pending the letting of a contract under RCW 47.28.170.

Funding

1. **Normal maintenance** is not eligible for federal reimbursement because it is routinely scheduled or budgeted to historical levels. This work is funded out of the state-funded M2 maintenance budget. Normal work orders, charge numbers, and coding are used to track accomplishments and costs.

2. **Emergency maintenance** work may be eligible for federal reimbursement when properly approved by FHWA if the work at a defined site exceeds the threshold amount, currently \$5,000. This work is initially funded out of the maintenance budget and later reimbursed with federal funds. Disaster Maintenance (DM) work orders are established to ensure the department properly accounts for and documents expenditures.

As a footnote, there are other federal agencies which provide emergency funding, including the Federal Emergency Management Agency (FEMA) and the Corps of Engineers (COE). Each agency has different eligibility requirements. These are not discussed in this document.

Limitations on Contracting Out Maintenance Work

The department may contract out ordinary maintenance work instead of using state forces if:

- Such work was regularly done by a valid contract prior to April 23, 1979; and,
- The contract does not have the effect of terminating classified employees or eliminating classified employee positions existing at the time of the execution or renewal of the contract (see RCW 41.06.380).

If the proposed work activity has been **traditionally** or **historically** performed by state maintenance forces, it would be considered “ordinary maintenance.” Conversely, if the proposed work has been considered by the department as an “alteration, repair, or improvement” activity, as those terms are defined below, the proposed work is not considered “ordinary maintenance” and is subject to RCW 47.28.030.

If there is any question as to whether the activity can be considered “ordinary maintenance,” a good faith decision should be reached based upon the facts of each particular situation, keeping in mind the purpose of RCW 47.28.030. Support for this decision needs to be documented at the time it is made and submitted on the Work Order.

Emergency Projects in the Highway Construction Program

The project magnitude and scope should be reviewed to determine if the work is in maintenance (can be done with state forces or requires a contract) or it should be in the Highway Construction Program.

If upon reviewing the magnitude and scope of the work, Maintenance believes this project should be in the Highway Construction Program, they should immediately begin discussions with the Regional Program Manager giving that person all the available information they have about the project and why they feel the project should be in the construction program.

The Regional Program Manager will immediately contact the OSC Program Management Engineer or his office for concurrence that the project is construction program work and to establish a work order.

OSC Program Management, with help from Regional Program Management, will obtain approval and programming of the unprogrammed project and approval of the Work Order.

If the proposed work activity is not considered ordinary maintenance as defined above, the work may be accomplished by state forces only to the extent permitted in RCW 47.28.030 and RCW 47.28.035. This rule applies whether the work involves an emergency or not.

This work typically requires the use of preliminary engineering services and personnel and contract plans, specifications and estimates. When the work is not programmed, it follows the department's screening board unprogrammed project process.

Definition of Construction Type Activities

1. **Alteration** — Work that results in a substantial change in the form or nature of an existing highway facility/element without destroying its identity.

Examples include:

Realignment of the roadway
Widening the roadway
Raising the grade
Replace span wire with mast arms

2. **Repair** — Work required to restore the intended functionality of a highway facility/element when damage results in a substantial loss of the intended design functionality.

Examples include:

Major slide (may require soils analysis and walls)
Repair of large culverts
Replacement of major sections of riprap
Roadway paving
Replacement of bridges, bridge approaches, or bridge piers
Work needed to repair a section of washed out road that is not passable

3. **Improvements** — Work that results in the enhanced, expanded, or improved functionality of a highway facility/element over that of the original design. This work includes new roadway elements and improves the original function and design.

Examples include:

Culvert replacement to improve drainage
Constructing all weather highway
Constructing left turn lane or climbing lane
Hydraulic enhancements
Correction of unstable slopes through the use of horizontal drains, new wall, or other methods

Funding for Construction Work

Emergency work considered to be “alteration, repair, or improvement” when properly approved, is eligible for federal reimbursement, either from normal highway construction funds or Emergency Relief funds. Work is initially funded out of the highway construction program with state funds and later reimbursed with federal funds. Appropriate work order numbers are established to ensure the department can properly account for and document expenditures (see Section V. Maintenance Work Order Process).

Limitations on State Force Forces Accomplishing Construction Work

If the work involves “alteration, repair, or improvement” as defined above, the statutory requirements set forth in RCW 47.28.030 and RCW 47.28.035 apply as follows:

- The work may be done by state forces when the **estimated** cost of the work is **less** than \$50,000.
- When delay of the work would jeopardize a state highway or constitute a danger to the traveling public, the work may be done by state forces as long as the **estimated** cost of the work is **less** than \$80,000.
- If the estimated cost of a project is **more** than the \$50,000/80,000 limitations, state forces **may** still be used to perform work up to those limits. The cost of the remaining project work over the \$50,000/\$80,000 limits would have to be contracted out by competitive bidding.

RCW 47.28.035 sets out two rules that must be followed in estimating the cost of using state forces.

- First, the costs must include the aggregate of all amounts to be paid for **labor, material, and equipment** (see below).
- Second, the aggregate costs are those costs that will be incurred on **one continuous or interrelated project** where work is to be performed **simultaneously**.

Note: To better understand this second requirement, one must go beyond the actual statute language and the difficulty of defining the key term “project,” and focus on the objective of the statute. Its purpose is to ensure that a project is not artificially divided into smaller projects for the sole purpose of using state forces instead of contracting out the work.

The estimate must be reasonable based on the best information known at the time it was made. To support the reasonableness of the estimate, written documentation on how it was ascertained is necessary (RCW 47.28.030). The purpose of the dollar limitation is to ensure that the majority of non-maintenance emergency work is done by outside contractors. Therefore, the estimate should be reasonable in view of the facts that are known at the time and consistent with the purpose of the limitation. Any questions on what should be included in the estimate should be directed to the department so that the estimates are consistent.

The following examples are provided to help understand how the estimate should be made:

To be included:

1. **Labor costs** would be included when state personnel are being used on the project to do the following:
 - a. Operate equipment
 - b. Place material
 - c. Any activity done on site that would have been done by the contractor's labor force if the work had been contracted out.
2. **Material costs** that would be included are:
 - a. Material obtained from a WSDOT stockpile.
 - b. Material purchased, hauled, and placed by state forces.
3. **Equipment costs** to be included are:
 - a. Use of state-owned equipment.
 - b. Cost of rental equipment if the equipment is being operated by a state employee.

Not to be included:

1. In estimating labor costs, the following are not to be included:
 - a. Preliminary engineering costs (PE)
 - b. Construction engineering costs (CE)
2. **Material costs** that are not to be included are:
 - a. Material purchased from a contractor and contractor delivered to the site for the particular project. (If placed by state forces, the labor costs would be included, but not the material costs.)
 - b. Materials delivered to the site by the contractor and placed by the contractor's labor force. (Neither the labor costs or material costs are included because the work is being done by the contractor.)
 - c. Consumable items not incorporated in the project (e.g., traffic control devices, signs, etc.).
3. If the rental equipment is not being operated by a state employee, the cost of the rental is not to be included.
4. Overhead costs are not to be included.

3:P:DP/EPM

Definition of a Project

In order to meet the intent of RCW 47.28.030 and RCW 47.28.035, a project is defined as one continuous or interrelated project where work is to be performed simultaneously.

RCW 47.28.035 indirectly defines a project as the aggregate of all amounts to be paid for labor, materials, and equipment on one continuous or interrelated project where work is to be performed simultaneously.

Definition of Continuous and Interrelated

With the statute's objective in mind, one must remember that a project consists of a series of activities or events that must be accomplished to produce an intended result. The project is generally "continuous" in nature (both length and depth) until each required activity is completed to produce the desired outcome. Also, each activity cannot alone create the final result. They must be "interrelated" with other activities to establish the final goal and objective. The activities are part of the overall project and logically could not be considered as separate and independent projects. The statute simply says that the individual activities or units of work will not be considered as separate projects for the purpose of using state forces to do work.

Definition of Simultaneously

The statute also refers to work being performed "simultaneously." This term must be interpreted in view of what actually happens on a project. It's obvious not all of the activities can be done at the exact same time. However, they must be accomplished before the entire project is completed. For example, if the road is washed out, the end result is to replace the road. To accomplish this, the activities would include replacement of fill, riprap, crushed surfacing, paving, striping and guardrail. The work activities are not being phased because of future funding or other reasons; but simply continuing on until the work is completed and the new road is in place. As long as the activities are being carried in a logical sequence to produce the end result, the work is being done "simultaneously" for purposes of the statute.

Other Considerations

If several activities, each of which could be considered separate projects under RCW 47.28.035, have been combined for accounting and/or contracting convenience, the reason for the combination should be documented. This prevents an appearance that the dollar limitations have been exceeded.

In defining what a project is for purposes of estimating the cost of state forces, the following should be kept in mind:

1. The purpose of the statute is to preclude the department from dividing a proposed project into units of work or classes of work in order to avoid the dollar limitations set forth in RCW 47.28.030. If the project is being divided into artificially smaller elements, the statute is being violated.

Definition of a Project

2. There should be a reasonable basis for determining what a project is when estimating costs. Is it logical to group these activities into separate projects instead of one? Has the department done it before and what were the reasons for doing it that way? Does it make common sense? These questions need to be answered before we decide, in good faith, to divide the work into more than one project.
3. The definition of a project for purposes of RCW 47.28.030 and RCW 47.28.035 should be uniformly applied by the department.

The following examples explain how a project is determined for purposes of complying with RCW 47.28.030 and RCW 47.28.035. The examples are of situations where the work would be considered as a single project as well as examples where the department in good faith could consider the work as independent projects.

Example 1: Assume two major slides occur causing extensive damage to the roadway. The damaged areas are separated on the roadway by only a few feet. Technically, the work to clear and repair the two areas is not continuous because of the separation. However, since the distance is so minimal, the work in both areas would be considered as one continuous project. Also, RCW 47.28.035 refers to “. . . one continuous or interrelated project.” In the example, all of the work is interrelated because both areas would have to be repaired before that section of roadway could be used by the traveling public. Thus, for purposes of the statute, the work activities at both locations would be treated as one single project.

Example 2: Two major slides occur on the same highway but are located several miles apart. Unlike, Example 1, the distance between the slides is substantial so work at the two locations would not be considered as one continuous project. Also, the repair work at location one can be completed to open that section of the roadway independent of the repair work at location two. Thus, the work at the two sites is not interrelated. As a consequence, the work at the slide areas would be considered two separate projects.

Example 3: A slide covers one mile of road. In order to restore the road for traffic use, the following work activities must be done: (1) removal of debris; (2) replacement of fill material; (3) repair of the shoulders; (4) repaving; and (5) placement of new guardrail. Each of these activities are interrelated in order to put the road back into service. The work is also being done in a logical sequence so it is being performed “simultaneously.” Therefore, the sum total of the work would be considered as one project instead of five separate jobs for purposes of estimating the cost of using state forces.

Example 4: Three slides occur on the same highway. Two are located ten feet apart and the third one is located five miles to the north. The only work activities involved to open the roadway in all three locations is to remove the debris and clean the ditches. The issue of what is considered a project for

purposes of RCW 47.28.035 only applies where the activity involves either “construction, repair, alteration, or improvement work. Unlike examples, 1, 2, and 3, the work activities in this example would be considered emergency maintenance work. Therefore, state forces can be used to do all of the work regardless of costs and regardless of whether the three work areas are classified as one or more projects.

Example 5: A storm does damage to a bridge structure and two culverts in the same area. Work is done immediately to repair the culverts. However, because of lack of funding or other legitimate reasons, a decision is made to delay repair work to the bridge. Since the repair work on the culverts can be accomplished without repairing the bridge, the two activities are not interrelated. Also, the bridge work will occur at a later date so the work is not continuous. Therefore, the repair of the culverts and the subsequent bridge repair work can be treated as two separate projects.

Example 6: Work is done to correct unstable slopes in multiple locations. Each site can be corrected independent of the improvement work at the other sites. Also, the work is not continuous because of the separate locations. Therefore, the improvement work at each location would be considered a separate project.

Example 7: One rest area is damaged. The repairs include removal of debris, replacing sections of the sidewalk, and repaving. The work is continuous because all of the repairs are being made at one location. These activities are also interrelated because the repairs must be done in order to put the rest stop in the condition it was prior to the damage. The individual repair activities cannot be considered as separate projects but must be treated as one project for purposes of estimating the cost of using state forces.

4:P:DP/EPM

Maintenance Work Order Process (DM)

General

When an emergency/disaster occurs a method for capturing expenditures for the work both within the region as well as for federal emergency (ER) work is needed. The Work Order Authorization (WOA) is the method used to capture these expenditures. A separate WOA is normally set-up for each individual disaster site and has a unique identifying number. For a Disaster Maintenance (DM) WOA this number has a "DM" prefix.

The WOA is also used for budgeting purposes and in obligating federal funds; thus it is important that the WO is as current as possible and accurately reflects current and future expenditure needs.

Approval of the DM work order and assigning the "DM number" has been delegated to the regions. The specifics of this new process are listed below.

Disaster Maintenance (DM) work orders are initially set up with state funds since early on it is not known whether they will be eligible for federal participation or not. In many cases, part or all of the emergency work may be done prior to knowing if the project will receive federal participation. Once the magnitude of the disaster and the funding requirements are known and before OSC Accounting Services can bill FHWA for reimbursement, it may be necessary for OSC Maintenance to obtain a federal appropriation from the Office of Financial Management (OFM).

As a general rule (except for specific nonparticipating items), emergency work and/or incidental permanent work within 180 days of the disaster is eligible for 100 percent federal participation. Permanent work and emergency work after 180 days is eligible for federal participation at a federal pro-rata share for the route the work is on, in most cases 86.5 percent.

When requesting information from OSC on the status of a WOA, reference the work order number and the federal aid number if known.

In setting up DM work orders, region management and field personnel will also consider:

1. The need to prepare Detailed Damage Inspection Reports (DDIR) for FHWA review/approval that clearly define scope of work, type of work, location, and estimated costs of the emergency and/or permanent work.
2. The need to manage the DM setups and be accountable for the costs incurred under the DM setup.
3. That the region be able to ascertain, through inspection, that the work performed was accomplished in accordance with the scope and/or approved change orders to the DDIR.
4. The estimated cost associated with a work order setup. Because of the complexity of some emergency work it may be necessary to have some work orders for an estimated amount greater than the \$50,000/\$80,000 limit.

Procedures for Setting Up DM WOA

The current process is as follows:

<i>Action By</i>	<i>Action</i>
Region Maintenance Analyst or Designee	Assign DM Work Order Number and log required data. Prepare Work Order Authorization (WOA), get required signatures and FAX to OSC Accounting Services — Project Support Service Section (PSS) prior to noon of the first working day after the number is assigned.
OSC Accounting Office, Project Support Services Section	Set up the work order in TRAINS. Send a copy of approved work order to OSC Maintenance. Send a copy of approved work order to OSC Program Management.
OSC Program Management	Send the project to FHWA for obligation/ authorization (Form 120-006). Send a copy of the approved form to Region Program Management and the Maintenance Analyst.
Region	Ensure that charges are made to the appropriate group depending on the eligibility of the charges and the time frame in which they were incurred.
OSC Accounting Office, Project Support Services Section	Upon notification that federal funds have been approved, set up the federal funds on federal eligible groups per the federal agreement. Transfer the eligible expenditures which have accumulated from the state appropriation to the federal appropriation. Forward a copy of the journal voucher transferring the expenditures to the Region Accounting Office.

In order to minimize confusion, the following groups will be reserved for state force work:

- Group 01 — Emergency and Incidental Permanent Work within 180 days
- Group 02 — Emergency and Incidental Permanent Work after 180 days
- Group 03 — Permanent Work
- Group 04 — Non-Participating Work

It is **essential** that the group title be used with each group so that the appropriate expenditures can be moved if federal participation is received.

At the time of the initial DM set up, PSS will set up only the groups which have been requested by the region.

The groups on DM Work Orders are not limited to Group Category 04. As long as all other requirements have been met, other group categories may be used. For example, it is permissible to set up groups which are in Group Category 01 (Work Done Contract) or Group Category 02 (Work Done agreement). Other groups can be added later (by E-Mail) as long as the authorized dollars are not being increased.

Payments for Emergency and Incidental Permanent Work done after 180 days **must** be charged to the appropriate group. The key is when the work is done or goods received, not when the bill was paid. (If work was actually done **within** the 180 days it remains in Group 01 even though the bills may be paid **AFTER** the 180 day limit.) The 180 days is measured from the declared **first day** of the emergency, which may be prior to the date that the damage occurred.

Assignment of DM Work Order Numbers

Each region will assign their own DM Work Order numbers. The first two characters of the work order number will be DM (Disaster Maintenance) to indicate the type of work order. The third character of the work order will be used to define the region (DMAxxx for the Northwest Region, DMBxxx for the North Central Region, DMCxxx for the Olympic Region, DMDxxx for the Southwest Region, DMExxx for the South Central Region, DMGxxx for the Eastern Region). The next three characters are numeric and will be assigned sequentially by the region. The block of DM numbers will **not** be further subdivided.

In order to expedite work order set up, minimize confusion, and ensure that regions, OSC Maintenance, OSC Program Management, and OSC Accounting each has the information they need, the following rules will be observed.

1. Responsibility for assigning DM numbers will be assigned to an individual.
2. The individual (or designee) responsible for assigning DM numbers will be available to assign numbers whenever they are needed.
3. The individual responsible for assigning DM numbers will prepare the Work Order Authorizations for the DM Work Orders, acquire required signatures, and fax them to OSC Accounting Services, PSS Section prior to noon of the first working day following the assignment of the number.
4. DM numbers will not be reserved for potential work but only set up for actual projects.
5. Each region will maintain a log of DM numbers which carries the data elements that they require plus any other elements which may have been requested by OSC Maintenance, Program Management, and Accounting.

Work Order Authorization Form

A sample Work Order Authorization (WOA) form, 120-021 EF is included in Appendix. This form is available in electronic format. For consistency and to speed processing of work orders within OSC, we are requesting that all regions submit work order authorizations on this version of the form. It is not required that each region use the electronic format, only that the work order have the same information in the same format as the sample provided.

When preparing a WOA request, whether it is for a new setup or an adjustment to an existing setup, complete, accurate information must be provided.

It is important for federal emergency work that the region monitor the work order closely and at the end of the 180 time limit, when appropriate, switch from the Group for Emergency Work and/or incidental Permanent Work within 180 days to the Group for Emergency Work after 180 days.

Review by Region Prior to Submitting WOA

To aid processing within OSC, to reduce processing time and to minimize the number of errors, the regions need to completely and accurately fill in the areas identified on the sample WOA.

Prior to submitting an increase for a work order authorization to OSC an effort should be made to check TRAINS to ensure that all GROUP CATEGORIES will have sufficient authorization after the WOA is processed.

If a group is going to be set up on the work order which references a payable agreement, the agreement needs to be complete, through the OSC review process and ready for set up in TRAINS prior to submittal of the work order authorization to OSC Accounting. If the agreement is not completed prior to the WOA being submitted for approval, the group set up will be delayed until the reviewed agreement is received in OSC Accounting.

Work order authorization for a federal Aid Emergency Relief (ER) project containing **Permanent Work** must have the environmental documentation complete, the Right of Way certified and the design completed prior to receiving federal approval (this includes state force construction). When submitting a WOA for construction please include, along with the request, a copy of the estimate, design approval date (if applicable), the RW certification and the NEPA dates indicating the environmental classification of the project, (NEPA, CE, EA, EIS, etc.). Failure to have any of these items complete prior to submitting the funding request FHWA will result in delays of the funding approval and may delay the start of the project.

When to Submit a Work Order Authorization Increase

The Work Order Manager should periodically check the status of the work order. If TRAINS shows a WO is overrun, or it will soon overrun, and work is ongoing, a WO increase should be prepared and submitted to OSC. The increase should provide adequate funds to cover the overrun and estimated future expenditures. The

estimate should be reasonable and should be based on the best information available at the time. Significant increases/decreases to existing work orders need to be submitted prior to overrunning the WO whenever possible.

When reducing existing work orders prior to closure, consideration must be given to estimating expenditures that will occur prior to the work order actually closing. Submitting a request to reduce a work order to actual expenditures when the groups are still open will almost always result in the work order overrunning or the actual expenditures changing prior to the work order being processed through OSC.

Examples of Emergency Maintenance Work Orders

Parameters for this type of work activity are flexible to the extent that they are required to meet only one criteria, i.e., the cost of the activity described under the DM work order setup must be at least \$5,000 to meet FHWA eligibility requirements.

Parameters for a DM work order will be that they may be identified by Maintenance Section, Sign Route (in its entirety) or specific locations, so long as the type of activity being performed is functionally related or continuous in nature. Given these parameters, the following examples can be used by field personnel in reviewing and setting up Emergency Maintenance DM work orders:

Example 1:

High winds caused extensive damage to trees and signs along an entire maintenance area/sign route; in this case one DM work order may be used for the entire section. A similar example would be damage to signals in several locations where the work would be accomplished by the region-wide signal crew.

Example 2:

Bridge scouring and related erosion occurred at MP 79-Mill Cr. Br., MP 89-Twin Canyon Br., MP 108-Rainey Cr. Br., MP 116-Silver Cr. Br., and MP 123-Cora Br. In this example there are three options. Bridge scouring and related erosion may be considered one project since the work is similar in nature and repairs will be accomplished by one organization — the regions' Bridge Crew — and can all be placed on one work order. The second option is for the region to establish an individual work order for each location. This is desirable if there is a need to track the individual bridge repair costs. Or third, separate groups can be set up for each bridge on one work order.

In instances where repair activities on a single sign route are diverse in nature and/or widely separated in terms of miles of roadway field personnel may set up individual work orders (or they could be set up on one WO with a separate group for each type of work) for example:

Example 3:

SR 12, MP 71 to 75 slide clean up, ditch cleaning, culvert cleaning, and traffic control might be one work order.

Example 4:

SR 12, MP 143 to 148, roadway settlements in several locations may be a separate work order for the emergency/incidental permanent work performed by maintenance state forces.

Example 5:

SR 12, MP 154.5, loss of roadway. A DM work order would be set up to cover only the traffic control and emergency incidental/permanent work, with any permanent work to be handled either through the emergency bidding authority or as an unprogrammed project under the Preservation Program under a separate work order.

Example 6:

SR 12, MP 143 to 148 has emergency/incidental permanent work. Within that section at MP 145 to 146 there is a section of lost roadway that will require permanent work by contract using the unprogrammed project process. When setting up work orders, one work order is set up for the emergency/incidental work for the whole section while another would be set up to capture the permanent work for that part of the section.

5:P:DP/EPM

Emergency/Incidental Permanent/ Permanent Work

Introduction

Emergency work is that work done during or immediately following a disaster to restore essential traffic, to minimize the extent of the damage, or to protect the remaining facilities.

Emergency Relief work (including emergency work, incidental permanent work, and permanent work) at a site is eligible for ER funds if the damage was caused by the event and the cost of the work exceeds \$5,000/site. Since debris removal costs may be widespread rather than site-specific, FHWA will determine if the costs exceed heavy maintenance.

The Detailed Damage Inspection Report (DDIR), WSDOT Form 300-001EF, Appendix 3, and its approval is used to document the scope and eligibility of the work. Normally the Region Maintenance Analyst is responsible for preparing the DDIR along with FHWA. The DDIR must be prepared (normally by the region) and reviewed for eligibility by FHWA within 90 days after the ER event is approved by the FHWA Administrator. The DDIR divides the work on the project into three categories "Emergency, Incidental Permanent, and Permanent" work. The following is a further definition of these three categories.

Emergency Work

The intent of temporary operations, including emergency work, is to restore essential traffic which cannot wait for a finding of eligibility and programming of a project. Emergency work should be accomplished in a manner which will reduce additional work required for permanent work. The department will need to coordinate with resource agencies for permit requirements.

Emergency work may be eligible for 100 percent federal aid as long as the work is within the first 180 days after the emergency begins. The 180 days is calculated from the first date of the incident as determined with FHWA. The 180-day ending date will be shown on the FHWA Form 120-006.

The use of Emergency Relief (ER) funds for emergency work on roadways will normally be limited to the amount necessary to bring the washed-out fills and slip-outs back to grade with a gravel surface. In most cases the emergency work will not construct the roadway to a true line and grade but rather follow the terrain and be constructed in the easiest and fastest manner. Work on the roadway, nevertheless, should be adequate so that traffic can travel over it safely at a speed reasonable for the site conditions. Where routes handle heavy traffic, an appropriate type of bituminous surface as a emergency work will be eligible for short sections of roadway.

Incidental Permanent Work

FHWA's concurrence in the need for repair does not in itself authorize the agency to proceed with permanent restoration work on damaged roadways. However, there may be situations in which immediate completion of the permanent restoration portion of the work is the most economical and feasible way to quickly restore

essential traffic. In these situations the permanent restoration work is considered to be incidental permanent restoration work and can be performed with the emergency work, provided it is properly documented in the DDIR. If such work has been accomplished prior to the site damage review, retroactive approval may be given when circumstances warrant.

Documentation of this Determination is Essential

Example 1

An example would be a bridge and approaches being washed out, construction of a detour being both costly and time consuming, and the agency having precast concrete girders readily available that could be used at the site. In such a case, immediate construction of the permanent structure and approaches could be accomplished at the discretion of the agency and FHWA would consider the work to be incidental permanent restoration and would be documented and reimbursed in the same way as the emergency work.

Example 2

The placement of the final surfacing is normally considered to be permanent work. But, it may be considered incidental permanent restoration work in some cases. Such paving must have FHWA concurrence, on the DDIR or subsequent to the DDIR, to be eligible for federal participation. FHWA will consider traffic characteristics, remoteness of the site, traffic control requirements and socioeconomic factors before approval.

Permanent Work

Permanent repairs are those repairs undertaken, normally after emergency work has been completed, to restore the highway to pre-disaster conditions. Permanent repairs require a separate FHWA Form 120-006 **before** starting construction or going to bid if the work is contracted out. Any work performed prior to approval and authorization of the 120-006 **is not** eligible for federal reimbursement. (This is in addition to the 120-006 form required for the emergency or incidental permanent work.)

A work order authorization for **“Permanent Work”** needs to be submitted to OSC at least **three weeks** ahead of the planned start date to allow adequate time for processing in OSC (Program Management and Accounting) and with FHWA.

Permanent restoration is funded at the normal match rate for the route **regardless of when the work is done**. Permanent restoration shall be administered using normal federal-aid procedures that include written authorization, NEPA clearance, design approval, permits, right of way certification, PS&E, advertisement period, etc. Permanent restoration work must begin within two years after the event.

Permanent restoration may involve one or more of the following categories of work:

1. *Restoration-in-Kind*. The ER program provides for repair and restoration of highway facilities to predisaster conditions. Restoration-in-kind is the expected predominant type of repair to be accomplished with ER funds. Any additional features or changes in character from that of the predisaster facility are

considered to be betterments and are generally not eligible for ER funding unless they can be justified because of construction, economy, prevention of future recurring damage, or technical feasibility.

2. *Replacement Facilities.* Where a facility has been damaged to the extent that restoration to its predisaster condition is not technically or economically feasible, a replacement facility is appropriate. Replacement facilities should be constructed to current design standards. ER participation in a replacement roadway will be limited to the costs of current design standards of comparable capacity (i.e., number of lanes), and character (i.e., surfacing type, access control, rural/urban section). Replacement of a bridge will be the cost of a new bridge to current design standards for the type and volume of traffic it will carry during its design life.

ER participation may be prorated at the costs of a comparable facility when the proposed replacement project exceeds the capacity and character of the destroyed facility.

3. *Betterments.* A betterment is defined as any additional feature, upgrading or change in capacity, or character of the facility from its predisaster condition. Betterments are generally not eligible for ER funding unless justified on the basis of economy, suitability and engineering feasibility, and reasonable assurance of preventing future similar damage. Betterments should be obvious and quickly justified without extensive public hearing, environmental, historical, right-of-way or other encumbrances. The justification must weigh the costs of the betterment against the probability of future recurring eligible damage and repair costs.

Upgrading that results from construction of replacement facilities to current standards as defined above is not considered a betterment requiring further justification. However, with respect to roadways, increases in capacity or a change in character of the facility would be considered betterments and are not justified for ER participation.

Betterments which have been approved in the past with proper justification include:

- Installation of riprap
- Installation of hydraulic enhancements
- Relocation
- Increased waterway opening
- Slope/bank stabilization
- Slide stabilization
- Dike construction
- Raise grade of roadway

Betterments resulting from environmental or permit requirements beyond the control of the agency are eligible for ER funds, if these betterments are normally required when the agency makes repairs of a similar nature in its own work.

Minor relocations and alignment shifts are frequently advisable and are generally eligible for ER participation. However, any design changes made to avoid damage which could be expected to occur infrequently is questionable. Added features of appropriate protection, such as slope stabilization, slope protection, and slide prevention measures wherever practicable, must have proper support. Slide stabilization work has been declared ineligible in problem areas where slides recur regularly. The cost of monitoring slide stabilization measures after completion of the initial stabilization is not eligible. ER participation in the initial construction does not create a continuing ER responsibility for future additional work.

Betterments which are eligible for reimbursement will be addressed, agreed to and documented on the DDIR or approved separately by WSDOT and FHWA in response to a local agency request justifying the proposed betterment.

4. *Replacement-in-Kind.* Where extensive damage has occurred, ER funds may be used for replacement-in-kind as the proper solution but with current standard safety features. Where relocation is necessary, each case is considered carefully to determine what part of the relocation is justified for construction with ER funds.
5. *Wayside Areas.* Wayside areas include rest areas and truck weighing stations. Access and parking facilities at a wayside area can be cleared and protected as part of an ER project. Local agency and WSDOT maintenance facilities are not included.
6. *Replacement of Culverts.* Upgrading culverts to current standards must be specifically related to eligible disaster damage repair. Damaged culverts are eligible for repair in kind. Destroyed culverts are eligible for replacement to current standards. Area-wide upgrading of deficient culverts on an area or route basis is not eligible.
7. *Deficient Bridges.* This includes bridges unsafe in structural condition only and does not consider waterway opening, functional obsolescence or serviceability. A structurally deficient bridge which was not under construction or scheduled for replacement with other federal funds may be eligible. ER funds do not replace other federal funds nor will they fund permanent repairs if the bridge is scheduled for replacement. The following represent two common situations:
 - a. Bridge is damaged and is repairable. ER funds may participate in:
 - (1) Reasonable emergency work to restore travel.
 - (2) Repair of disaster damage to restore a bridge to a structurally safe condition
 - (3) Repair of disaster damage if other funds are used to simultaneously correct the structural deficiencies (ER funds cannot be used to correct structural deficiencies).
 - b. Bridge is destroyed or repair is not feasible. ER funds may participate in:
 - (1) Reasonable emergency work to restore traffic.
 - (2) New comparable replacement structure to current standards if bridge was not scheduled for replacement.

8. *Bridge Betterments.* Two common bridge betterment situations are:
- a. Bridge is destroyed. A new comparable replacement structure would be eligible. Betterments are generally not a consideration except:
 - (1) Extensive relocation of a replacement bridge is an ineligible betterment and ER participation will normally be limited to the cost of the structure and a reasonable approach length.
 - (2) Replacement of a current non navigable structure or movable bridge with a high level navigable structure is beyond the intent of a comparable facility and is an ineligible betterment.
 - b. Bridge is seriously damaged, but repair is feasible. Repair-in-kind is eligible for ER funds.

Added protection features such as riprap, spur dikes or additional channel work if justified as a betterment would be eligible (i.e., there is reasonable assurance that similar future damage would be prevented and the cost of the betterment does not unreasonably exceed anticipated future ER costs).

9. *Control Features.* Stream channels outside the agency's right-of-way are generally not eligible. Work involved in channel changes, hydraulic enhancements, riprap, bank protection, clearance of debris and wreckage from the channels and stream beds, and other associated permanent work is not eligible. However, if the agency can establish it has jurisdiction and responsibility for the maintenance and proper operation of this section of the stream the work may be eligible. Normally, projects associated with channel work (riprap, bank protection, etc.) that require right-of-way purchases and/or easements outside the right-of-way are not eligible. The fact the agency responsible for channel maintenance does not have funds to finance the repair and protection work, is not an acceptable reason for ER fund assistance. In situations involving requests for participation in erosion control and bank protection outside the agency right-of-way, the following items must be verified by the agency to obtain eligibility:

- The work is directly related to protection of the highway facility.
- The work is not eligible for funds from another agency.
- No other agency has the responsibility for such work.
- The applicant agrees to accept the future maintenance of all work performed.

When work of this type is proposed, the project documents should include a letter from the local agency covering all four of the above features including acceptance of the responsibility for maintenance. Other supporting data should include copies of correspondence with the Corps of Engineers or other appropriate agency to verify that no other eligibility or responsibility exists.

- Increased bridge width or other geometric improvements and correction of non disaster-related structural or surfacing improvements such as deteriorated pilings or decks are not eligible.

10. *Protective Work.* When permanent and emergency work cost considerably less than proposed protective measures such as riprap, eligibility of protective measures is questionable. For example, if repairs consisting of replacement-in-kind cost only \$5,500 and the estimated cost to provide sufficient protection to prevent damage under similar unusual conditions is \$9,000, participation beyond that necessary for replacement-in-kind would not be economically justified.
11. *“Convenient” Damage.* To eliminate a recurring annual maintenance problem based on the occurrence of a disaster is questionable. For instance, the department proposes to replace a damaged triple box culvert and roadway fill with a bridge. This is a betterment to alleviate an annual maintenance problem which was accelerated by a disaster. ER participation in the construction cost of a bridge is limited to the amount necessary to restore the triple box culvert.
12. *Rock and Mud Slides.* The removal of rock and mud slides is eligible unless determined to be a pre-existing condition. Such a slide, unless justified on their own as a catastrophic failure, must be associated with the overall natural disaster and must have occurred during the event period as determined by FHWA and/or FEMA.

When an old slide has been activated during a natural disaster, its correction to provide a safe roadway is eligible. Should the agency propose to relocate a road instead of correcting the old slide, the cost of the relocation to predisaster capacity and character may be eligible if justified as a betterment.

Slide stabilization is also a betterment. ER participation must be based on detailed analysis of the slide and reasonable assurance of preventing similar future damage, showing stabilization costs do not unreasonably exceed anticipated ER costs. Such analysis must include road relocation, do-nothing alternatives and consideration of previous testing recommendations for the area.
13. *Plugged Culverts.* Cleaning out plugged culverts is an eligible activity as long as it is considered beyond heavy maintenance and is associated with other eligible damage. Replacement of plugged culverts should be considered eligible only when justified as a betterment or when cleaning is not cost effective.

Additional Examples of Emergency/Incidental Permanent/Permanent Work

Example 1

- a. The fill section of a road failed, leaving a two-lane road impassable. WSDOT Maintenance Crew blocked traffic and proceeded to bring in fill material. Once the material was in place, the crew opened the road to traffic on gravel. At this point essential traffic had been restored, therefore the emergency work was complete. Paving the surface was accomplished a month later due to other reasons. Therefore, the paving and striping is considered permanent work. The emergency work would be eligible for 100 percent ER and the permanent work would be eligible for the standard pro-rata share for that highway.
- b. Same example, except, the paving is immediately accomplished. Since the crew had most of the equipment already at the site while doing the fill work, it was decided that it would be more cost effective to complete the project while doing the emergency work. Because it was more cost effective to complete

along with the emergency work, this permanent restoration would then be considered incidental permanent and funded at 100 percent level by FHWA. In this example the emergency work and incidental permanent restoration would both qualify for 100 percent ER funds.

Example 2

- a. A bridge washed out making the highway impassable. A temporary bridge was constructed until the main bridge was replaced. The temporary structure restores essential traffic and is therefore eligible for 100 percent ER funding. The replacement of the bridge would be permanent restoration eligible for the standard pro-rata share for that highway.
- b. Same example, except due to the location, no temporary detour can be constructed, therefore, the bridge replacement becomes incidental permanent replacement and if accomplished with 180 days is eligible for 100 percent ER funding because it is required to restore essential traffic.
- c. Same example, a detour is constructed, the old bridge is removed, and a year later a new bridge is constructed and detour is removed. The detour construction would be emergency work at 100 percent ER funding, since it serves to restore essential traffic and prevent damage to the remaining facility. The removal of the old bridge, construction of the new bridge, and the detour removal would be permanent restoration eligible for reimbursement at the prorata share.

Example 3

- a. A large slide covered the highway making it impassable and due to the threat of continued activity, the department made the decision for safety reasons not to allow any work on the slide. The department constructed a detour around the slide. This detour is emergency work required to restore essential traffic and is eligible for 100 percent ER funding. The removal of the slide material is considered permanent restoration and is eligible for the standard pro-rata share for that highway.
- b. Same example, except the department has determined that the slide material is too expensive to remove and due to the size of the slide would not be a safe work environment, therefore, the decision was made to make the detour alignment a permanent structure. Since the detour is required to restore essential traffic, it would be considered emergency work/incidental permanent restoration and would be eligible for 100 percent ER funding, if completed within the first 180 days.

Example 4

- a. A section of roadway sinks. Maintenance fills up the hole, and opens the road to traffic. A short time later roadway sinks again, requiring the same fix. The roadway sinks a third time a little later requiring the same fix. Finally, the roadway stabilizes. Because all of the work described was required to restore essential traffic and preserve the existing roadway, all of the work would be 100 percent federal funding emergency work, if completed within the first 180 days.

6:P:DP/EPM

Purpose and Scope

To provide guidance in contracting out emergency work in accordance with the applicable statutory laws and in the administration of the resulting contract.

Rules

If an outside contractor is to perform work during a declared emergency, the rules set forth below apply regardless of whether the work is considered a maintenance activity, construction activity, or a combination of both.

1. Regardless of the estimated dollar amount of the contract, the contractor must be prequalified. If the estimate is \$50,000 or less, D-27 60 may be used to expedite the qualification process.
2. If the work involves the emergency protection and restoration of highways, RCW 47.28.170 allows alternative contracting methods regardless of the size of the contract. The department may solicit written bids (at least three bids) for the work without publishing a call for bids and then award the contract to the lowest responsible bidder.

The department may also contract without bids for emergency work under the same statute for a period not to exceed 30 working days. The price of the work would be negotiated but could not exceed the cost of doing the work by force account. The 30-day time frame cannot be extended. However, at the end of the 30-day period, the department may have the remaining emergency work done by obtaining at least three written bids and awarding the contract work to the lowest responsible bidder.

3. If the emergency contract work will not exceed \$50,000, the department need not require a bid deposit nor a performance bond. If a performance bond is not required, however, progress payments to the contractor may, at the discretion of the Region Administrator, be conditioned on submittal of paid invoices to substantiate proof that disbursements have been made to laborers, materialmen, mechanics, and subcontractors from the previous partial payment. If the contract will exceed \$50,000, a performance bond is required.
4. RCW 60.28.011 requires that 5 percent of the moneys earned by the Contractor be withheld by the public agency as a trust fund for the protection and payment of (a) the claims of any person arising under the contract and (b) state taxes which may be due from the Contractor. This requirement applies to all public improvements or work, other than for professional services. If the Department does not properly withhold the money, or if the money is refunded to the Contractor without the appropriate clearances from Claimants, the Department will be obligated to pay legitimate claims and/or taxes up to 5 percent of the contract amount as a substitute for the retainage fund. This obligation cannot be avoided, however, where the cost of withholding the money exceeds the amount withheld, it may be a prudent business decision to accept the risk of the obligation.

Contracting

5. Since the work is being contracted out, the department must follow all rules regarding the payment of prevailing wages. In addition, if federal reimbursement will be sought for the project, it will be necessary to include the required federal aid contract provisions.
6. Regardless of the dollar amount of the work, the department shall prepare a written contract setting forth the terms, conditions, and responsibilities of the contractor, including reference to the applicable *Standard Specifications*. A contract form is attached for this purpose.

Contracting Procedures

Once the decision is made to enter a contract with an outside entity:

1. Prequalification (Required in all cases)
 - a. Less than \$50,000? Use Abbreviated Process (Form DOT 272-063)
 - b. More than \$50,000? Use a firm already prequalified or call Pre-contract
2. Wages
 - a. No federal dollars involved? State Wage Laws Apply
Statement of Intent and Affidavit of Wages Paid
 - b. Federal dollars involved? Davis-Bacon Act applies
Required Federal Aid Provisions
Payrolls and Interviews Required
Statement of Intent and Affidavit of Wages Paid
Exception for Owner-Operators
3. Bond
 - a. Under \$50,000? Not required (Consider Invoice Verification)
 - b. Over \$50,000? Performance Bond is required
4. Retainage
 - a. Always required
 - b. Pay taxes and claims/verify and release
 - c. Obligation if not retained
 - d. Could require a bond in lieu of retainage
5. Written Contract is Required
6. Type of Contract
 - a. Negotiated, single contractor, no bids
 - (1) Can't exceed 30 working days
 - (2) Getting close? What to do.

- b. Solicited Bids
 - (1) Three required
 - (2) Needs bid documents — description of work and quantities
- c. Conventional Published Call for Bids
 - (1) Plan preparation
 - (2) Review process
 - (3) Policy inclusions? Training? Disadvantaged Business?

Contract Administration Procedures

1. Layout

The responsibility for layout (defining the work on the ground — surveying, staking, etc.) of the work is the state's, unless the contract provisions say otherwise.

2. Materials

If standard items are used, they must meet the *Standard Specifications* requirements and they must be sampled and tested as required by the *Construction Manual*. Regions may insert special provisions that call out other specs. These should be approved by Roadway (after-the-fact approvals are possible, but there is a risk).

3. Inspection

A state employee must either be present, or must be able to see the work done since the last visit.

4. Payment

Using Contract Administration and Payment System (CAPS), estimates are prepared. If CAPS is not used, payments may be made by voucher. If the work is being funded under the construction programs, CAPS and Construction Contract Information System (CCIS) must be used. The use of CAPS leads to the assignment of a “00” contract number. CCIS entries are needed and are made by the region.

5. Subcontracting

Subs can do up to 70 percent of the work. Subs must be approved by the state and must follow all of the same requirements as the Prime Contractor.

6. Retainage

Retainage is done automatically by CAPS and all reviews, clearances, and claims are automatically tracked by CAPS. If the work is being paid by voucher, the originating office will need to withhold 5 percent and, at the end of the job, ascertain that taxes and claims have been satisfied before releasing

the funds. If retainage is not withheld, WSDOT would be responsible for claims and taxes up to 5 percent of the amount paid. This might be a risk worth taking when the cost of retaining exceeds the amount retained.

7. Wages

On all jobs, the Prime and all subs must submit a Statement of Intent to Pay Prevailing Wages, obtained from Labor and Industries, and provide an Affidavit of Wages Paid at completion. On federal-funded jobs, the state must collect certified payrolls from the Prime and all subs. The state must also conduct field interviews of employees to confirm the amounts shown on the payrolls.

8. Changes

Any changes to the work must be in writing and must be approved by the Region Representative, the Region Construction Engineer, or the OSC Construction Office, depending on the nature of the change (see the *Construction Manual* for guidance).

9. Closure

The region is responsible for determining the final payment amount, preparing final records, and as-built plans.

Project Closure

Once the work is complete, and if the project is federally funded, two separate actions must take place.

1. All work orders associated with the federal aid project must be closed.
2. The federal aid project must be closed. This requires the region to prepare the following form and submit it to OSC Project Support Services with a copy to OSC Program Management and FHWA.

The closure and the form to be used depends on which program the project is in.

1. **Projects in M2** — Closure of “DM” projects by Maintenance Administration — Form 422-100A
2. **Projects in the Highway Construction Program** — Closure of “00” and “MS” projects by Construction Administration — Form 422-100EF

When required, a Final Acceptance Form is prepared by OSC Construction Office and submitted to OSC Project Support Services with a copy to OSC Program Management and FHWA. **Ninety days after final acceptance of the project by the Assistant Secretary for Field Operations, the OSC Accounting Services Office will change all construction work orders to state funds and the federal project will be closed.**

Betterments Per FHWA Memorandum

The ER program is intended to assist the states in repairing damaged highway facilities to their predisaster condition. In-kind restoration is the predominate type of repair. However, on occasion, a state may decide to incorporate additional features into the repair work that help protect the highway facility from future disaster damage, or to make changes that modify the function or character of a highway facility from what existed prior to the disaster. These added protective features or changes to the function or character of the facility are viewed as betterments for the purposes of the ER program. Betterments involving added protective features are not eligible for ER funding unless found to be cost-effective in terms of reducing probable future recurring repair costs to the ER program. Betterments that change the function or character of the facility are generally not eligible for ER funding.

The first category of betterments includes those that help protect highway facilities from possible future damage.

Examples are:

- Raising roadway grades,
- Relocating roadways to higher ground or away from slide prone areas,
- Stabilizing slide areas,
- Stabilizing slopes,
- Installing riprap,
- Lengthening or raising bridges to increase waterway openings,
- Deepening channels,
- Increasing the size or number of drainage structures,
- Replacing culverts with bridges,
- Installing seismic retrofits on bridges,
- Adding scour protection at bridges, and
- Adding spur dikes.

If a betterment involving an added protective feature is included in an ER repair project, the betterment may be considered eligible for ER funding under 23 CFR 668.109(b)(6) if it can be economically justified based on an analysis of the cost of the betterment versus projected savings in costs to the ER program should future disasters occur. This cost/benefit analysis must focus solely on benefits resulting from estimated savings in future recurring repair costs under the ER program. The analysis **cannot** include other factors typically included in highway benefit/cost evaluations, such as traffic delays costs, added user costs, motorist safety, economic impacts, etc.

It is recognized that in many instances betterments will fail to meet the test of being economically justified for use of ER funding. If ER funding cannot be provided for a betterment, this does not mean that the betterment should necessarily be excluded from the ER repair project. If a betterment provides considerable benefit when other factors are considered, the state is encouraged to use regular apportioned federal-aid highway funds, as appropriate, to fund a betterment.

One exception to the above discussion on betterments associated with added protective features involves grade raises associated with basin flooding. The FHWA has determined that raising the grades of critical federal-aid highways faced with long-term loss of use due to basin flooding is eligible for ER funding (see 23 CFR 668.109(b)(8)). In these instances, if the FHWA Administrator finds that a basin flooding event is eligible for ER funding, reasonable grade raises require no further economic justification as betterments.

Another exception involves repairs of features, such as bridges, that may require permits or approvals from other entities. If these other entities are routinely requiring added features as standard industry practice on other projects of similar nature to the ER project, then these added features can be included on the ER project without further justification as a betterment.

The second category of betterments includes changes to the function or character of the facility.

Examples are:

- Adding lanes,
- Upgrading surfaces, such as from gravel to paved,
- Improving access control,
- Adding grade separations, and
- Changing from rural to urban cross-section.

In general, betterments that change the function or character of a facility are not eligible for ER funding. One exception is established under 23 U.S.C. 120(e) that allows ER funding participation in replacement bridge facilities that can accommodate traffic volumes over the design life of the bridge, thus potentially allowing ER funding for added lanes on bridges.

Examples:

Situations where use of ER funding for repair activities is **not** considered a betterment are:

- Replacement of older features or facilities with new ones — the mere fact that a damaged highway feature or facility is replaced with something new that may extend the service life of the facility, in and of itself is **not** a betterment.

Incorporation of current design standards — repaired facilities may be built to current design standards, which could result in improved or added features that do not change the function or character of the facility. For example, a repaired length of roadway may have wider lanes or shoulders and additional roadside safety hardware that result from following current design standards. This is **not** a betterment.

Replacement in-kind on existing location not practical or feasible — on rare occasions, when it is neither practical nor feasible to replace a damaged highway facility in-kind on its existing location, an alternative selected through the environmental/public involvement process, if of comparable function and character to the destroyed facility, is eligible for ER funding. This is **not** a betterment. (See the following discussion on replacement facilities for more information on this special situation.)

Additional required features resulting from the environmental process — ER projects may include additional required features as an outcome of the project being developed in accordance with the NEPA process. These features are eligible for ER funding. This is **not** a betterment. (See the following discussion on environmental considerations for more information.)

8:P:DP/EPM

Replacement Facilities

A state may decide to replace a damaged highway facility with a new replacement facility. The extent of ER participation varies depending on the circumstances involved. Various scenarios, with examples, are discussed below.

In the first scenario, a highway facility has been seriously damaged; however, inspection verifies that it is possible to repair and restore the existing facility. Although the facility is repairable, the state decides it wants to replace the existing facility with a new or alternative facility. In this case, ER funding can be applied towards a new or alternative replacement facility; however, ER funding is limited to the ER program share of the estimated cost to repair the existing facility. Regular apportioned federal-aid highway funds may be used to fund project costs above the amount eligible for ER funding.

Example 1:

An elevated structure serving as a portion of a non-Interstate route in an urban area, although seriously damaged by an earthquake, does not collapse. It is determined the structure is repairable at an estimated cost of \$50 million. The state does not want to repair the elevated structure, but instead wants to replace it with an alternate facility at-grade or depressed. If the alternate facility provides comparable traffic service and will accommodate the known corridor traffic demands of the predisaster facility, then ER funds may participate in the federal share of the replacement facility up to an amount of \$40 million in ER funds (\$50 million estimated cost of repair multiplied by the 80 percent federal share for non-Interstate ER repair work). This is commonly referred to as capping the amount of eligible ER funds.

In a second scenario, a highway facility has been seriously damaged and inspection confirms that it is not repairable. The state decides it wants to replace the existing facility with an in-kind replacement facility (of comparable function and character to the damaged facility) on the existing location. In this case, ER funding may participate in the total cost of the replacement facility.

Example 2:

A bridge on a non-Interstate route crossing a river is heavily damaged and collapses during flooding. It is determined the bridge cannot be repaired, but must be replaced. The state decides to replace the bridge at the existing site and the replacement structure costs \$5 million to build. Emergency relief funding may participate in 80 percent of the incurred costs, which in this example amount to \$4 million.

In a third scenario, a highway facility has been seriously damaged and inspection confirms that it is not repairable. Although it is feasible to build a replacement facility at the location of the existing facility, the state chooses to replace the existing facility with an in-kind replacement on a new location. In this case, ER funding for the replacement facility is limited (capped) to the ER program share of the estimated cost to replace the facility in-kind at its existing location. Regular apportioned federal-aid highway funds may be used to fund project costs above the amount eligible for ER funding.

Example 3:

In the same example used in the second scenario above, instead of replacing the bridge at the existing site, the state chooses to replace the bridge at a new site a half mile downstream, using this as an opportunity to improve the overall alignment of this section of roadway. Because of stream characteristics at the new downstream bridge site, a longer structure is required. Also, the new site requires a mile of additional approach work. The result is that a bridge at the new site costs an additional \$2 million (to a total of \$7 million) above the estimated cost to replace the bridge at the existing site. For this \$7 million project, ER funding may participate in the federal share of costs up to an amount of \$4 million (\$5 million estimated cost of replacement at the existing site multiplied by the 80 percent federal share for non-Interstate ER repair work).

In a fourth scenario, a highway facility has been seriously damaged and inspection confirms that it is not repairable. Additionally, because of the very unique circumstances involved, it is also determined that it is neither practical nor feasible to replace the facility in-kind at its existing location. Consequently, an alternative replacement facility is developed through the NEPA process that is on new location. Provided this alternative is of comparable function and character to the destroyed facility, it is eligible for ER funding. It is noted this scenario rarely arises under the ER program. In almost all cases, it is practical or feasible to replace a damaged facility in-kind on its existing location, and the determination that the facility must be built on a new location is intended to be an extremely stringent test.

Example 4:

A rural non-Interstate highway, located in a valley area, is blocked by a massive landslide that also dams up a river in the valley. The landslide forms an earthen dam, backing up the river and forming a lake. Two miles of roadway are submerged under a significant depth of water. A decision is made by authorities that the landslide formed dam will remain in place along with the lake it has created. It is determined it is neither practical nor feasible to replace the highway at the existing location. As a result, the highway must be relocated and the appropriate replacement facility, developed through the environmental/public involvement process, becomes a relocated facility, 4 miles in length, bypassing the submerged section of roadway. The relocated facility costs \$20 million to build and ER funding may participate in 80 percent (\$16 million) of this total cost.

Environmental Considerations

Repair projects under the ER program must comply with NEPA requirements. Emergency repairs restoring essential travel, minimizing the extent of damage, or protecting remaining facilities have been classified as categorical exclusions under 23 CFR 771.117. Likewise, ER projects that involve permanent repair work to restore the existing facility in-kind at the existing location are likely to be viewed as categorical exclusions.

For ER projects that include betterments, even if the betterments are not eligible for ER funding, careful environmental review is needed. Although on the surface it may appear that a project qualifies as a categorical exclusion, certain betterments may be of enough significance that an environmental assessment or environmental impact statement is appropriate. For ER projects that involve constructing replacement facilities, environmental assessments or environmental impact statements may be required, particularly where a replacement facility on new location is being proposed.

As a result of an ER project being developed in accordance with the NEPA process, it may be necessary for the project to incorporate added features to mitigate impacts associated with items such as wetlands, noise, endangered species, etc.

In the case of an ER project incorporating such added features, if these added features are associated with a betterment determined eligible for ER funding, in turn the added features are also eligible for ER funding. If the added features are associated with betterments not eligible for ER funding, funds other than ER funding are to be used to construct the added features.

In the case of ER replacements projects, where ER funding may fully participate in the replacement facility (the second and fourth scenarios described above), any required added features are eligible for ER funding. These are not viewed as betterments, but rather as integral parts of the replacement project needed to comply with NEPA.

For alternative facilities where ER funding participation has been capped (the first and third scenarios described above), ER funding will participate in the replacement facility, including any added features, only up to the capped amount established for ER funding.

10:P:DP/EPM



Declaration of Emergency

For the purpose of documenting the use of alternative bidding procedures under RCW 27.28.170 and estimating the costs of using State Forces for emergency work under RCW 47.28.170.

1. Date of Emergency	2. SR	3. MP Location/Limits	4. County
5. Preliminary Estimate: <input type="checkbox"/> Up to \$80,000 <input type="checkbox"/> \$80,000 to \$200,000 <input type="checkbox"/> \$200,000 and Greater			6. Work Order No. (if known)

7. Cause and Description:

8. <input type="checkbox"/> Maintenance Superintendent* <input type="checkbox"/> Director, Regional Administrator or Designee** <input type="checkbox"/> Secretary of Transportation or Designee***	9. Signature
	10. Date

* Projects for \$80,000 or less can be authorized by the Maintenance Superintendent.

** Over \$80,000 requires authorization by the Regional Administrator.

*** \$200,000 and over requires review with the Transportation Commission by the Secretary of Transportation or designee.

1. Record the beginning date of the project.
2. Record the State Route (SR) number affected.
3. Record the mile post location.
4. Record the county the damage occurred in.
5. Check the appropriate box based on the preliminary estimate.
6. Record the work order number (DM, MS, etc.,) if known.
7. In brief narrative, explain the cause of the event, describe the damage and the need to use emergency procedures.
8. Check the appropriate box for the level of signature authority.
9. Signature of appropriate authority.
10. Date the declaration is signed.

Distribution: Original - Retained by Region; Copy - Olympia Service Center Office of Emergency Management

DOT Form 540-021 EF
Revised 4/99

◆ Supersedes Previous Editions ◆



Washington State
Department of Transportation

**Disaster Maintenance
Work Order Authorization**

Work Order Number DM	Supplement No.	Sub Program M2	Manager	Organization Code
SR(s)	MP From	To	County(s)	
Work Order Title			Control Section(s)	
Work Description			Source of Funds <input type="checkbox"/> State <input type="checkbox"/> FEMA <input type="checkbox"/> ER (FHWA) <input type="checkbox"/> Other	

Group	Group Category					Subtotals
	01 Work Done Contract	02 Work Done Agreement	03 Construction Engineering	04 State Force Work	Other (Specify)	
Previous Authorization Totals	0.00					\$0
Emerg./Incid. Perm. Work Within 180 Days						
Emerg./Incid. Perm. Work After 180 Days						
Permanent Work						
Non-Participating Work						
This Request Amount						
New Authorization Totals	0.00					\$0
Total Emergency & Incident Perm. Work	Total Permanent Work		Total Non-Part.	Total Authorization		

Additional Project Information

Notes to Accounting

For Federal Aid Projects Only

FA Number _____ FA % _____ FA Appropriation _____ FHWA Auth. Date _____

NEPA Approval Date _____ Right of Way Required
 Yes No

Initiated By _____ Date _____

Expenditure Authorization By _____ Date _____

Copy Distribution:
 OSC Maintenance OSC Program Management

DOT Form 120-021 EF
1/99



Washington State
Department of Transportation

Detailed Damage Inspection Report
FHWA Emergency Relief

Applicant		County(s)	FHWA Disaster No.
Location of Damage (Name of Road or Street)		Milepost	Inspection Date
		From _____ To _____	Federal-Aid Route
Description of Damage (Include Bridge Number(s) if Applicable)			Local /State Project No(s).

Cost Estimate (Including Preliminary and Construction Engineering)

Temporary/Emergency Repair and Incidental Permanent Restoration work are eligible for 100% Federal participation until

Temporary/Emergency Repair (<i>Work required to restore essential travel and protect the remaining facility from immediate threat.</i>)		Temp./Emerg. Repair
Method of Work: <input type="checkbox"/> Local/State Force Account <input type="checkbox"/> Emergency Contract		Total Temporary Repair \$
Incidental Permanent Restoration (<i>That portion of the permanent work which has been determined to be more economical to be constructed along with the Temporary/Emergency work.</i>)		Incid. Perm. Restoration
Method of Work: <input type="checkbox"/> Local/State Force Account <input type="checkbox"/> Emergency Contract		Total Incidental Perm. \$
Permanent Restoration (<i>This work is eligible for Federal participation at the standard matching ratio. This work must receive additional FHWA authorization before advertisement.</i>) Describe any proposed betterments and their eligibility.		Permanent Restoration
Method of Work: <input type="checkbox"/> Local/State Force Account <input type="checkbox"/> Contract		Preliminary Engineering _____ Right of Way _____ Construction _____ Total Perm. Restoration \$
NEPA Environmental Classification <input type="checkbox"/> Categorical Exclusion <input type="checkbox"/> EA/EIS	Total Estimated Cost \$	
Recommendation <input type="checkbox"/> Eligible <input type="checkbox"/> Ineligible	FHWA Engineer	Date
Concurrence <input type="checkbox"/> Yes <input type="checkbox"/> No	State Representative	Date
Concurrence <input type="checkbox"/> Yes <input type="checkbox"/> No	Local Agency Representative	Date

At the time of this inspection, all work was complete; therefore, this report constitutes the final field inspection.

DOT Form 300-001EF
1/97



**Washington State
Department of Transportation**

**Inspection of
Federal-Aid Projects**

Washington Division		Report Number	Date of Inspection	Federal-Aid No.	
Cont. No.		Project Title			
Type of Inspection	Inspected By	Quality of Work	Progress of Work	Time Elapsed	Work Completed
<input type="checkbox"/> Interim <input type="checkbox"/> Final	<input type="checkbox"/> Region <input type="checkbox"/> Construction Office	<input type="checkbox"/> Satisfactory <input type="checkbox"/> Unsatisfactory	<input type="checkbox"/> Satisfactory <input type="checkbox"/> Unsatisfactory	%	%
Inspection Made By			In Company With		

Remarks:

DOT Form 422-100 EF
10/94



**Washington State
Department of Transportation**

**Inspection of Federal-Aid
Projects in Maintenance Program**

Project Number	Program M2	Region	Federal-Aid No. ER-
County(s)		Project Title	
Type of Inspection <input type="checkbox"/> Interim <input type="checkbox"/> Final	Inspected By <input type="checkbox"/> Region <input type="checkbox"/> Construction Office	Quality of Work <input type="checkbox"/> Satisfactory <input type="checkbox"/> Unsatisfactory	Progress of Work <input type="checkbox"/> Satisfactory <input type="checkbox"/> Unsatisfactory
Date Work Started: _____		Date Work Completed: _____	
Project Cost	Temporary/Incidental Permanent Work	Permanent Work	
State Force Work:	_____	_____	
Contract / Agreement Work:	_____	_____	
Sub Total:	_____	_____	
Ineligible Work:	_____	_____	
Total Cost:	_____	_____	
Description of Work:			
Remarks:			
Inspector's Signature	Inspector's Title	Date of Inspection	In Company With

DOT Form 422-100A EF
5/96

cc: Funds Mgmt. Engr., MS47325; Project Support Supvr., MS 47420; FHWA Olympia, MS 0943



Transmittal Number PT 05-015	Date February 2005
Publication Distribution To: All holders of the Work Zone Traffic Control Guidelines	
Publication Title Work Zone Traffic Control Guidelines	Publication Number M 54-44
Originating Organization Maintenance and Operations, Traffic Office	

Remarks and Instructions:

General:

- Complete revision of book to ensure it complies with current edition of MUTCD and current WSDOT standards.
- Basic content has been retained in the text, expanded the established guidance from previous manual by providing additional information and guidance in broader areas to try and capture major elements and operations affecting traffic control procedures.
- Revised wording for protective & shadow vehicles to comply with MUTCD wording. Updated TMA information as per manufacturer comments, WSDOT Design Manual and AASHTO Roadside Design Guide.
- Revised the format to be consistent with other WSDOT manuals by going to 3 hole punch style, this also helps users with updates to the manual.
- Annual updates or earlier if needed.

Guidance:

- Added new guidance for devices: warning lights, temporary & portable signal systems, highway advisory radio.
- Safety office provided updated information for the section on Personal Protective equipment.
- Added guidance for addressing pedestrians, bicycles and other roadway users.
- Added guidance for additional work zone considerations: work zone speed limits, worker protection, survey work zones, public information & coordination and road closures.

Plan sheet revisions:

Generally cleaned up the original plans from 2000 version to look more proportional, remove extraneous information to reduce clutter on sheets, fixed typo's, expanded notes on plan sheets to be consistent from sheet to sheet. Added new plans to address statewide issues and comments and expand guidance.

- Expanded number of plan sheets from 24 to 31
- Buffer Data Block on all the plan sheets has been revised to meet industry standards.

Stationary Work Zone section, plans (TCP1 to TCP13):

- Maintained all plans from previous version of the manual but updated the plans to be consistent with current standards.
- Separated the flagger controlled plan and pilot car operation into two separate plans to provide additional guidance. (Reflects department policy on cone use with pilot car operation.)
- Added a new plan sheet to show typical on and off ramp closure details.

Short Duration Work Zones, plans (TCP14 to TCP20):

- Added a complete new section to include guidance on Short Duration Work Zones. Multiple pages of text to provide recommendations and guidance, 7 new plan sheets to show typical operations.

Mobile Work Zones (TCP22 to TCP27):

- Revised plans to be consistent with WSDOT standards and to clarify information shown on plan sheets.
- Removed snowplow and avalanche control operation plan sheets.

Intersection Operations (TCP28 to TCP30):

- No major changes or revisions cleaned up sheets to be consistent with the rest of the manual and MUTCD.
- Emergency Operations (TCP 31):
- No major changes or revisions to this section, provided additional warning signs and revised general notes for additional recommendations and clarity.

Special Details (TCD1 to TCD5):

- Revised a few plans, removed the old TCP reference chart, included new plans for motorcycle warning sign placement, lane closure with a shift, and updated the speed zone detail and pavement marking details.

Appendix:

- Included a new appendix section that holds WSDOT directives and guidance and work zone safety bulletins.
- Added new guidance for use and placement of traffic control devices called “Channelizing Device Application Matrix”.

Who to Contact:

Please contact Marty Weed (360) 705-7293 WeedM@wsdot.wa.gov with questions, comments, or suggestions for improvements to the manual. Contact Engineering Publications at (360) 705-7430 regarding distribution of the manual.

Available On-Line:

The Work Zone Traffic Control Guidelines, M 54-44, is available on the Internet at:

<http://www.wsdot.wa.gov/fasc/EngineeringPublications/Manuals/Workzone.pdf>

Instructions:

Chapter	Replace			
Replace old manual with the new February 2005 edition.				

Distributed By Directional Documents and Engineering Publications	Phone Number (360) 705-7430 FAX: 705-6861	Signature <i>Stephanie Williams</i>
---	---	--

Work Zone Traffic Control Guidelines

January 2005
M 54-44

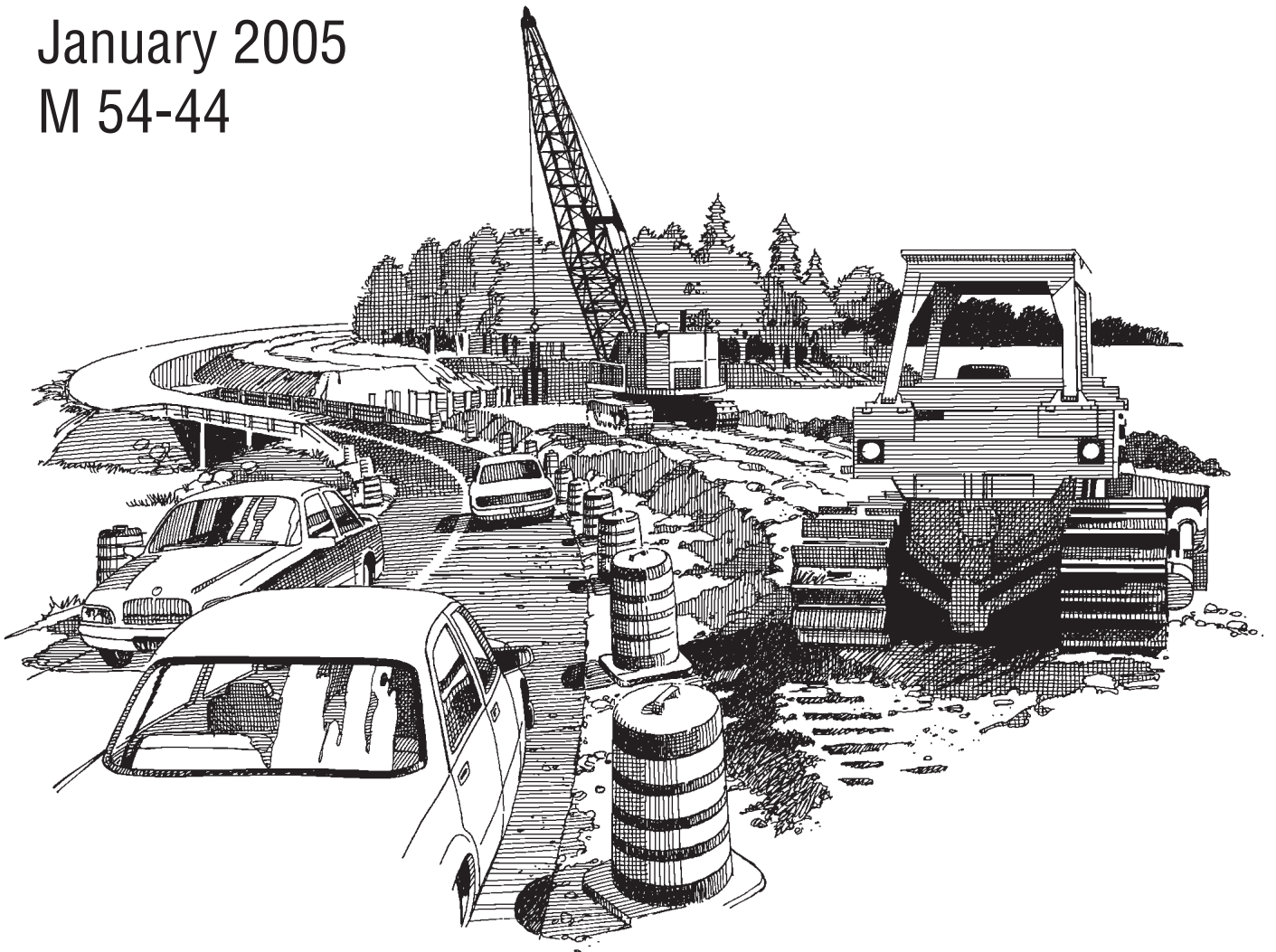

Washington State
Department of Transportation



Persons with disabilities may request this information be prepared and supplied in alternate forms by calling the WSDOT ADA Accommodation Hotline collect (206) 389-2839. Persons with hearing impairments may access WA State Telecommunications Relay Service at TT 1-800-833-6388, Tele-Braille 1-800-833-6385, or Voice 1-800-833-6384, and ask to be connected to (360) 705-7097

Additional copies of the Work Zone Traffic Control Guidelines may be purchased from:

Engineering Publications

Washington State Department of Transportation

PO Box 47408

Olympia, WA 98504-7408

E-mail: enrpubs@wsdot.wa.gov

Phone: (360) 705-7430

Fax: (360) 705-6861

Work Zone Traffic Control Guidelines M54-44 is on the Engineering Publications CD Library of Technical Publications and can also be downloaded, free of charge, from this location on the WSDOT home page:

<http://www.wsdot.wa.gov/FASC/EngineeringPublications/>

Additional work zone safety information is available at the WSDOT HQ Traffic Operations homepage:

<http://www.wsdot.wa.gov/biz/trafficoperations/workzone/default.htm>

Forward

While this booklet provides interpretive guidance, it does not change the intent of Part VI of the Manual on Uniform Traffic Control Devices (MUTCD). The traffic control devices and distances shown in this booklet reflect desired minimums for state routes.

Effective traffic control is essential, not only for the safety of the traveling public, but also for WSDOT employees and those whose jobs often require them to be in close proximity to high-speed traffic. The traffic control guidelines in this booklet are intended to reduce field personnel's exposure to the hazards of traffic and offer road users consistent and positive guidance through work zone areas. Safety of crews and the driving public must be an integral part of WSDOT field operations.

We emphasize that these are guidelines and not absolute standards. The traffic control plans in this booklet are to be used along with sound judgment. Proper planning, a good safety conscious attitude and full participation from the persons involved in the work zone are all prerequisites to good traffic control. Aspects of the roadway environment such as weather, time of day, traffic volumes, traffic speed, roadway geometry, roadside conditions, and your inventory of traffic control devices should all be considered when implementing the guidelines of this booklet. If you have any questions or needs not addressed here, please consult your Regional Traffic Office staff.

Be assured that along with the Work Zone Safety Task Force, we are committed to securing increased funding for better and safer work zones through the legislative process to meet your workforce and equipment needs.

Don Nelson

Gummada Murthy

Environmental and Engineering
Director

Maintenance and Operations
Director

Comment Request Form

From: _____ Date: _____
_____ Scan: _____
_____ Phone: _____

To: State Traffic Engineer
310 Maple Park Avenue SW
PO Box 47344
Olympia, WA 98504-7344

Subject: *Work Zone Traffic Control Guidelines* Comment

Addition Correction
 Deletion Other

Comment (Marked copies attached):

Preserve this original for future use - Submit copies only

Contents

	Page Number
Introduction	1
Instructions	1
Considerations	1
Personal Attributes	2
Equipment	3
Flagging	10
Pedestrians, Bicycles and Other Roadway Users	11
Additional work zone considerations	13
Checklist for Establishing a Temporary Traffic Control Zone	15
Taper and Buffer Space Details	17
Taper/Channelizing Device Taper	18
Stationary Work Zones	19
TCP 1 Alternating One-Way Traffic - Flagger Controlled	20
TCP 2 Pilot Car Operation	21
TCP 3 Single Lane Closure for Multi-Lane Roadways	22
TCP 4 Double Lane Closure for Multi-Lane Roadways	23
TCP 5 Shoulder Closure – Low Speed (40 MPH or Less)	24
TCP 6 Shoulder Closure – High Speed (45 MPH or higher)	25
TCP 7 Temporary Off-Ramp for Multi-Lane Roadways	26
TCP 8 Temporary On-Ramp for Multi-Lane Roadways	27
TCP 9 Temporary On-Ramp (Right Lane Closed)	28
TCP 10 Right Lane Closure with Shift – (5 Lane Roadway)	29
TCP 11 Left Lane and Center Turn Lane Closure – (5 Lane Roadway)	30
TCP 12 Lane Shift/Three Lane Roadway	31
TCP 13 Typical Short-Term Ramp Closure	32
Short Duration Work Zones	33
Short Duration Work Zone Considerations Chart	40

	Short Duration Work Zones Do's and Don'ts	42
TCP 14	Typical Short Duration Lane Closure – 2 Lane Operation	43
TCP 15	Typical Short Duration Lane Closure – Multi-Lane Operation	44
TCP 16	Typical Short Duration Shoulder Work	45
TCP 17	Typical Short Duration – Intersection Location	46
TCP 18	Typical Very-Short Duration Work Operation	47
TCP 19	Typical Very-Short Duration Work Operation	48
TCP 20	Typical Very Short Duration – Intersection Location	49
Rolling Slowdown		50
TCP 21	Typical Rolling Slowdown	51
Mobile Work Zones		52
TCP 22	Mobile Freeway Operation – Left Shoulder Closed	53
TCP 23	Mobile Freeway Operation – Left Lane Closure	54
TCP 24	Mobile Freeway Operation – Middle Lane Work Area	55
TCP 25	Mobile Operation Lane Closure – Two-Lane Roadway	56
TCP 26	Mobile Operation Shoulder Closure – Two-Lane Roadway	57
TCP 27	Mobile Shoulder Operation with Lane Encroachment	58
Intersection Operations		59
TCP 28	Intersection Lane Closure – Three Lane Roadway	60
TCP 29	Intersection Lane Closure – Five Lane Roadway	61
TCP 30	Typical Intersection Pedestrian Traffic Control	62
Emergency Operations		63
TCP 31	Flood or Slide Emergency Plan	64
Special Details and TCP's		65
TCD 1	Shoulder Work Area Protection – Non-Working Hours	66
TCD 2	Typical Motorcycle Warning Sign Sequence	67
TCD 3	Typical Lane Closure with Shift	68
TCD 4	Typical Speed Zone Detail – Chip Seal Projects	69

TCD 5	Temporary Pavement Marking Details	70
Appendix – Work Zone Safety Bulletins		71
Appendix 1-1 Flagger Safety Bulletin		73
	New Rules Memo	75
	Summary of Rules	77
	Flagger Hazard Awareness Briefing	81
Appendix 2-2 Work Zone Signs Bulletin		83
	Approved Type X Sign Sheeting Examples	86
Appendix 3-3 Traffic Control Plans Bulletin		87
Appendix 4-4 Channelization Device Application Matrix		89
Appendix 5-5 Worker Safety During Paving Operations Directive		91

Introduction

The primary function of work zone traffic control is to allow vehicles, cyclists and pedestrians to move safely and easily through or around work areas. Effective temporary traffic control enhances traffic safety and efficiency. Drivers and pedestrians need to be guided in a clear and positive manner while approaching and traversing temporary traffic control zones.

The traffic control plans contained in this booklet are furnished as a guide to be used along with good judgment. Minor modifications may be made, as necessary, to accommodate site conditions; however, a plan's original intent must be maintained. An alternate plan should be considered if substantial revisions are needed. Consult the Region Traffic Office Staff for additional guidance.

Traffic control plans and procedures consistent with these guidelines should be developed to address the specific needs of work operations that are not included in this guide.

This set of traffic control plans is not intended to satisfy all conditions for all work zones. The Manual on Uniform Traffic Control Devices (MUTCD) is adopted by WSDOT as the legal standard. Principles set forth in Part VI of the MUTCD titled "Temporary Traffic Control" are represented in this booklet to provide traffic control guidance for common work operations.

This guidebook does not specifically address individual types of work operations. Standards do not allow exceptions based on work type. Many types of work operations such as surveying, maintenance, utility, developer, etc. can be applied to the guidance and plans contained within.

The typical applications (TA's) shown in MUTCD Part 6 may/should be considered and used as needed to develop or implement TCP's within the intent of this guidance.

Instructions

Considerations

1. Provide substantial protection and minimize worker exposure to traffic by applying barriers and devices in practical ways. Long-term projects may warrant the use of concrete barrier while short-term projects can be better served by a truck-mounted attenuator (TMA). Always consider the use of positive protection.
2. Prior to the beginning of work operations, evaluate all aspects of the work area, including sight distance, traffic speed, volume, road approaches and the type of work activity, before deciding on a traffic control plan.
3. After the traffic control plan is implemented, the supervisor (i.e. the person(s) supervising the actual work task(s) for which the TCP was implemented – e.g. Maintenance Lead Tech, Construction Project TCS(s) – both WSDOT and contractor, survey party chief) should drive through the work area, at the anticipated speed of the motorists, to determine the effectiveness

of the plan. Additional reviews throughout the day are recommended to insure that traffic control devices remain in place.

4. Traffic control devices shall be moved ahead whenever work advances to more than 2 miles from the advance warning signs.
5. Contact region traffic management center (TMC) prior to starting work when appropriate, based on region polices. Also consider coordination with region public information officer (PIO) for public notification when adverse traffic impacts are anticipated.
6. Plan ahead for manpower, equipment, and materials, (such as signs, channelizing devices, pavement marking materials, etc.) needed for traffic control.
7. The distances shown on the traffic control plans are desirable minimum requirements. Device spacing, buffer space, and sign spacing might require adjustments to provide for site conditions. Reductions in taper length distances are not allowed. Reductions in roll-ahead distances are allowed, see page 4, item number 5 for additional information.
8. The Washington State Patrol is available to assist WSDOT by enforcing excessive speed and impaired driver laws in critical work zone traffic control situations. These may include nighttime lane closures on high volume/high speed freeways or road closures. Contact the Region Traffic Office Staff for specific information regarding procedures to utilize the WSP.
9. Traffic control devices are used to visually guide drivers through work zones. Signing, channelizing devices, arrow panels and warning beacons all display a message to the driver. Work zone credibility is established through the proper use of these devices to send correct messages to drivers. Poor work zone credibility has a direct, negative, impact on work zone safety by causing driver confusion, frustration and disrespect which results in a high potential for accidents.
10. During paving operations, temporary pavement markings shall be maintained throughout the project. Temporary pavement markings shall be installed on the roadway that was paved that day. Temporary pavement markings shall be in accordance with page 70, TCD5 (Temporary Pavement Marking Details) and Std. Spec. 8-23.
11. Traffic delays due to work zone restrictions must be addressed. Excessive delays contribute to work zone incidents of road rage or crashes. Traffic capacity issues must be addressed with the region traffic office prior to starting work. Traffic should not be allowed to back up past the advance warning signs. Sign locations may need to be adjusted to fit actual site conditions or additional signs added to the sequence.

Personal Attributes

1. **Awareness:**
Routinely working near traffic for extended periods of time can cause workers to become complacent to the danger around them. Therefore, it is necessary to continually remind ourselves and those around us of the dangers to which everyone is exposed.

2. **Alertness:**
There is no place on a “*traffic exposed*” work crew for a daydreamer or distracter. Each individual, for their own protection and that of the crew, must stay constantly alert and watchful.
3. **Attitude:**
A positive, safety-conscious, attitude on the part of each crewmember will contribute greatly to the overall safety of crew operations.
4. **Responsibility:**
Each person is responsible for ensuring their own safety and to see all standards are followed. This includes ensuring temporary signs, warning devices, and flag persons are placed appropriately to protect both the motorists and workers. **Motorist and worker safety are of primary importance.**

Equipment

1. **Traffic Control Device Crash Test Requirements:**
After October 1, 2000, all new purchases of Category II traffic control devices (portable sign stands with signs, type 1, 2, & 3 barricades, vertical panels, intrusion alarms, and other work zone devices under 100 lbs.) shall be compliant with the federal NCHRP 350 crash test requirements. WSDOT will phase out existing devices as they complete their normal service life. All Category II devices will be "350" compliant by December 31, 2007.
2. **Condition and Care of Equipment:**
All personal equipment and traffic control devices shall be kept clean to provide protection for the crew through better visibility to the motorist. The condition of signs and traffic control devices shall be new or “acceptable” as defined in the book “*Quality Guidelines for Work Zone Traffic Control Devices*”, and will be accepted based on a visual inspection. A sign or traffic control device determined to be “not acceptable” shall be removed from the project. Copies of the Quality Guidelines book may be obtained from ATSSA.
3. **Signs:**
Signs that are no longer retro-reflective (visible and legible at night) or are in poor condition are to be replaced. Standard 48" x 48" temporary warning signs are diamond shape with black letters or symbols on an orange background. See appendix 2-2, page 83-86 for information on work zone signs and example sheet of sheeting samples.

Some work areas might require the use of special or regulatory signs, contact region traffic office for assistance with special signs. Use of double-faced (back-to-back) signs is not allowed. Sign supports must be in good condition and be capable of withstanding normal wind stresses along the highway.

4. **Vehicles:**

- **Work Zone Vehicle** - All construction vehicles, except hauling vehicles, used within the work zone must be equipped with an approved flashing warning beacon. Consideration must be given to the location of workers in relation to the work vehicles. Worker safety can be jeopardized if the motorists' attention is focused on the work vehicle and beacon when the workers are at an unexpected location.
- **Protective Vehicle** - Usually a stationary vehicle (in stationary work zones) strategically placed in advance of the work area, between the buffer space and the roll-ahead space, to protect workers from oncoming traffic. The use of a Truck Mounted Attenuator (TMA) on this vehicle is recommended. Allow for roll-ahead distance resulting from an impact. Refer to the data block on the TCPs for specific information. The Protective vehicle can be a work vehicle if no other vehicles are available.
- **Shadow Vehicle** - Very similar to the protective vehicle but usually a moving vehicle (mobile work zones). All of the above guidelines for the protective vehicle applies to the shadow vehicle except for the roll-ahead distances only apply to a stationary operation. A sequential arrow panel or truck mounted Portable Changeable Message Sign (PCMS) may also be used on the shadow vehicle.

5. **Truck Mounted Attenuators (TMA):**

A truck mounted attenuator (TMA) is a portable impact attenuator attached to the rear of a large truck. Ballast is added to the truck to minimize the roll-ahead distance when impacted by a vehicle. The TMA is used as a shield to prevent errant vehicles from entering the work zone. If a TMA is not available, the use of a protective or shadow vehicle is still highly recommended.

Considerations:

- **Speed of Traffic** - Higher operating speeds leave less reaction time and impacts generally result in more severe injuries and damage. Therefore, the higher the operating speed the more probability that a TMA is necessary.
- **Type of activity** - Mobile, intermittent or stationary.
- **Duration of project.**
- **Roadway environment** - Access controlled vs. non-access controlled, urban vs. rural, and roadway geometrics. Access controlled facilities frequently give drivers a false sense of security since interruptions are not expected. Therefore, activities on freeways may be more susceptible to incidents than are activities on non-access controlled facilities, where drivers are generally more alert.
- **Traffic volumes** - More traffic means more worker exposure.

- **Exposure to special hazards** - Operations involving personnel on foot or located in exposed positions (for example, on the approved platform of a pickup truck placing cones or in a lift-bucket performing overhead operations) are particularly susceptible to high severity incidents.
- **Location of work area** - Locations of primary concern are those within the traveled lanes or within frequently used, all-weather, shoulders. Activities taking place within the traveled lanes are more likely to become involved in an incident than are shoulder activities.
- **Roll Ahead Distance** - The 30 foot roll ahead distance shown in the BUFFER DATA block on the TCPs is based upon a minimum 15,000 lb. vehicle weight impacting the TMA and is the recommended minimum distance to be used. A protective vehicle is recommended regardless if a TMA is available. If no TMA is used, the protective vehicle shall be strategically located in the field to shield workers and no specific roll ahead distance has been provided.
- **TMA's must be certified as NCHRP 350 compliant.**

6. **Portable Changeable Message Signs (PCMS):**

- Recommended for high speed, high volume roadways, or work operations that require a highly visible message.
- Shall ***not*** be used to replace required signs. Can be used to replace static message signs for short duration or moving operations, as per approved traffic control plan.
- Place in advance of other temporary traffic control zone signing.
- Shall meet the minimum visibility and legibility standards established in the MUTCD.
- Should be able to read the message twice at the posted speed.
- Each individual display should convey a single thought.
- A complete message cycle should consist of ***no more than two*** displays in sequence. Refer to MUTCD for a list of acceptable message abbreviations.
- Bottom of sign panel shall be a minimum of 7' above roadway.
- PCMS shall automatically adjust its light source relative to surrounding conditions.
- Messages shall not scroll horizontally or vertically across the sign face.
- Consider use of a truck mounted PCMS for protective vehicles.
- Consider use of permanently located changeable message signs when applicable.
- PCMS should be placed on the shoulder of the roadway, or if practical, further from the traveled lane. They should be delineated with traffic control devices or shielded with a barrier or crash cushion. When signs are not being used, they should be removed.

7. **Arrow Panel:**

- **Required for all lane closures on multi-lane roads, except during emergencies.**
- Arrow panels shall meet the minimum size, legibility, legibility distance, number of elements, and other specifications as shown in the MUTCD.
- An arrow panel shall not be used on a multi-lane roadway to laterally shift traffic.
- An arrow panel shall not be used on a two lane, two-way roadway.
- An arrow panel shall only be used in the caution mode when used for shoulder closures.

- Only the **four-corner flash** shall be used to indicate caution.
- Use ***only one*** arrow panel per lane being closed (unless used in mobile operations).
- Arrow panel should be used in combination with other appropriate traffic control devices. When arrow panels are not being used, they should be removed.
- Arrow panel shall be capable of a minimum 50 percent dimming.
- For stationary lane closure, the arrow panel should be located on the shoulder at the beginning of the taper. Where the shoulder is narrow, the arrow panel should be located in the closed lane.
- The arrow panel shall be located behind channelizing devices (unless used in mobile operations).
- An arrow display mounted on a shadow (early warning) vehicle is allowed on mobile lane closure operations.
- Type “C” arrow panels are required for high-speed stationary lane closures. Type “B” arrow panels are allowed for mobile lane closures. (See MUTCD Part 6F)

8. **Channelizing Devices:**

Traffic safety cones are the most common devices used to separate and guide traffic past a work area. Cones must be 18" tall, except for high speed, high volume, or nighttime operations, where they must be 28" tall, and retro-reflectorized. Traffic safety drums must be 36" tall, and are recommended for use in the tapers on high-speed roadways due to their greater visibility and imposing size. Maximum spacing requirements are shown on the TCP's. The Table on page 18 is provided to help select the proper taper lengths and number of devices needed. Tighter spacing may be desirable, under some conditions, to enhance motorists' guidance. Refer to Appendix 4-4, page 89, Channelizing Device Matrix, for additional guidance.

9. **Temporary Concrete Barrier:**

Temporary concrete barrier is designed to prevent intrusion of errant vehicles into work areas. Recommended for long-term stationary work areas with high exposure to traffic. Refer to the WSDOT design manual and contact the Region Traffic Office Staff for site specific placement information.

Consider the following for use of concrete barriers:

- Areas where there is a high potential for injury to workers or "no escape" areas such as internal lane work, work zones in tunnels, bridges, lane expansion work, etc.
- Long term, stationary jobs (work occupying a location for more than 3 days).
- Areas of high exposure to workers and motorists such as high speed and high volume of traffic.
- The approach ends of temporary concrete barriers shall be fitted with impact attenuators to reduce the potential for occupant injury during a vehicle collision with the barrier. Examples of impact attenuators are shown in Design Manual Chapter 720.

10. **Water Filled Barrier:**

Water filled barriers are longitudinal barrier systems that use light weight modules pinned together and filled with water to form a barrier. They are ***not intended*** as a replacement for concrete barrier but are an improvement over traffic cones and drums to channelize traffic through a work zone. In emergency maintenance situations, they may be considered for short-term use as a substitute for concrete barrier.

Contact the Region Traffic Office, or HQ Design Office, for advice on use of this device and assistance in determining the deflection space requirement behind the barrier.

11. **Barricades:**

Generally used to protect spot hazards but can also be used to close roadways and sidewalks with appropriate signing. Barricades can also be used to provide additional protection to work areas.

12. **Warning Lights:**

These lights are either flashing or steady burn (Types A, B, or C or strobe) mounted on channelizing devices, barriers and signs. Secure warning lights to the channelizing device or sign so they will not come loose and become a dangerous flying object if impacted by a vehicle. See the MUTCD, Part VI for additional information.

- Type A – low-intensity flashing warning light used to warn road users during nighttime hours they are approaching a potentially hazardous area.
- Type B – high-intensity warning light used to warn road users during both daylight and nighttime hours.
- Type C – steady-burn warning light designed to operate 24 hours per day to delineate the edge of the roadway.

13. **Flares:**

All work vehicles should carry a supply of flares. Use flares only to alert drivers to emergencies and not as routine traffic control device. Emergencies are defined as unexpected events where life threatening conditions, injuries or property damage may occur unless immediate action is taken. Use caution at accident sites where flammable materials, such as fuel spills, are suspected.

Consider the following for use of flares:

- Primarily used in high hazard conditions only (i.e. accidents, spills, equipment breakdowns, dangerous snow and ice conditions, etc.)
- Use electronic flares or orange/red-glow sticks instead of incendiary flares where flammable materials are suspected.

14. **Temporary and Portable Signal Systems:**

Temporary traffic control signals are typically used in work zones to control traffic such as temporary one-way operations along a one-lane, two-way highway where one lane is closed and alternating traffic movements are necessary. Examples of work operations are temporary one-way operations on bridges and intersections. Contact the region traffic office and signal

superintendent for specific guidance and advice on the use of these systems. A traffic control plan is required for use of these systems.

- Temporary signal system - typically a permanent signal system modified in a temporary configuration such as temporary pole locations during intersection construction, span wire systems, adjustment of signal heads to accommodate a construction stage.
- Portable traffic signal system – a trailer mounted traffic signal used in work zones to control traffic. These versatile, portable units allow for alternative power sources such as solar power, generator and deep cycle marine batteries in addition to AC power.

15. Highway Advisory Radio (HAR):

Roadside radio system that provides traffic and traveler related information (typically affecting roadway being traveled) via AM radio. The system may be a permanently located transmitter or a portable trailer mounted system that can be moved from location to location as necessary. Contact the region traffic office and signal superintendent for specific guidance and advice on the use of these systems.

16. Specific Warning Sign Requirements

Examples:

- Abrupt Lane Edge
- Motorcycles Use Extreme Caution
- Bump
- Traffic Revision Ahead
- Road Narrows
- Grooved Pavement
- Rough Road
- Loose Gravel
- No Shoulder
- Water Over Roadway

Not all warning signs are shown on the traffic control plans but are required to address specific work zone hazards when conditions warrant, particularly if the hazard is not obvious or cannot be seen by approaching motorists.

17. Personal Protective Wear:

The wearing of soft caps is **permitted in accordance with the WSDOT Employee Head Protection Instructional letter IL 4011.05 and the Personal Protective Equipment Chapter of the Safety Procedures and Guidelines Manual. Hard hats are required when working on or around the following:**

- Asphalt Plant, Crushers, Blasting Area, and Asphalt grinding operations.
- Construction of bridges, structures, retaining walls, etc.
- Overhead work such as working in a trench, rock-fall areas, sign installation, installing poles, work under bridges, electrical conductors, etc.
- Working near operating equipment with arms, booms, buckets, etc.
- Work around cranes, pile driving, drilling.
- During work as a flagger.
- Brush cutter work, danger tree work, and other logging operations.

- On any construction site whenever there is a potential exposure to danger from falling objects to persons working or occupying the area.
- Any designated hardhat area.

Supervisors have the authority to require employees to wear hard hats for other activities where there is a danger from impact and/or penetration of falling and flying objects. Employees must have a hard hat on site and readily available for use when work conditions require their use.

High Visibility Clothing

While working on foot in a highway right of way (fence line to fence line) or in other areas where job duties are performed in close proximity to moving vehicles, WSDOT workers must:

- Wear retro-reflective vests, except that during daylight hours, an orange T-shirt with two 2-inch wide yellow stripes front and back may be worn in lieu of the retro-reflective vest. Flaggers must wear retro-reflective vests and hard hats at all times.
- The retro-reflective vest shall always be the outermost garment.
- During hours of darkness, wear vests and either white coveralls or high visibility orange pants with 4 yellow strips.
- **Exceptions to these high visibility requirements:** (1) when personnel are out of view of, or not exposed to, traffic, (2) when personnel are inside a vehicle, or (3) where it is obvious that such apparel is not needed for employee safety from traffic.

The standard WSDOT vest is either:

- ANSI/ISEA standard Class II Fluorescent Orange-Red textured Woven polyester vest with Fluorescent lime yellow or ANSI approved equal strips from state contract,
- ANSI/ISEA standard Class II lightweight Fluorescent Orange-Red Mesh vest with Fluorescent lime yellow or ANSI approved equal strips from state contract, or
- ANSI/ISEA standard Class II Surveyors with Fluorescent lime yellow or ANSI approved equal strips from state contract.

A standard WSDOT approved T-shirt may be purchased by WSDOT employees and worn in lieu of the WSDOT Safety Vest by employees during daylight hours and when not working as a flagger. T-shirts shall not have any words or “ads” affixed to them. The WSDOT T-shirt standard requires a crew neck, base color orange, minimum 2 each 2” horizontal yellow bars on front and back with at least 2” apart vertically. The supervisor and/or Region Safety Officer shall have final approval authority over both the T-shirt itself and its use.

Contractor personnel working on WSDOT projects who are on foot in the highway right of way (fence line to fence line) or in other areas where job duties are performed in close proximity to moving vehicles, should:

- Wear retro-reflective vest, except that during daylight hours, clothing of orange, yellow, strong yellow green or fluorescent versions of these colors may be worn in lieu of vests. Flaggers must wear the retro-reflective vests and hardhat at all times.
- The retro-reflective vest shall always be the outermost garment.
- During hours of darkness, wear retro-reflective vests and white coveralls or high visibility ANSI class II coveralls or ANSI class E pants.
- When contractor workers wear rain gear it shall be yellow or high visibility orange with yellow strips.
- Exceptions to these high visibility requirements: (1) when personnel are out of view of, or not exposed to, traffic, (2) when personnel are inside a vehicle, or (3) where it is obvious that such apparel is not needed for employee safety from traffic.

Flagging

- Flagging should be employed only when all other methods of traffic control are inadequate to direct, or control, traffic.
- Locate the flagger off the traveled portion of the roadway. More than one flagger may be necessary to achieve traffic control in both directions. A means of communication between flaggers must be considered in these situations. Communication by hand held radio is the recommended procedure.
- Only persons who have successfully completed an approved flagging course and who possess current flagging certification recognized in Washington State can be used as flaggers.
- Freeway characteristics do not lend themselves to effective flagging. High speed multiple lanes and normal driver expectancy do not provide an opportunity for the flagger to actually warn or direct traffic, therefore flagging on freeways and freeway ramps is not normally recommended. However, using a “spotter” may be helpful to protect the work crew.
- In a mobile flagging operation, all signs associated with the flagger shall be moved ahead whenever work advances to more than 2 miles from the advance warning signs; also, **the “flagger ahead (symbol or text message)” sign is recommended to be within 1,500 feet of the flagger, any time a flagger is deployed.**
- During hours of darkness flagger stations shall be illuminated without causing glare to the traveling public.
- When flagging in the vicinity of signalized intersections special consideration must be made to address the specific needs to traffic movements. The signal must be either turned off or set to red “flash” mode. At no time shall traffic be flagged with an active signal.
- The placement of a flagger at the center of an intersection to control traffic is not allowed, the only person allowed to legally control traffic from the center of an intersection is a uniformed police officer. See Appendix 1-1, pages 73-81, Flagger Safety bulletin for additional information.

Flagger's Rules of Conduct

1. Be clearly visible to approaching traffic at all times.
2. Do not stand in front of parked/stopped cars.
3. Always be aware of oncoming traffic.
4. Do not step into, or turn your back on the traffic.
5. Stand on the shoulder of the road observing traffic and the work zone. You may have to stand on the opposite side of the road to effectively direct traffic around the work.
6. Choose the best flagging position that will provide the greatest color contrast between you and the background.
7. If at all possible, do not stand in the shade.
8. Never flag from inside a vehicle.
9. Do not lean, sit or lie on a vehicle.
10. Stand alone. Do not permit a group of workers to congregate around you.
11. Familiarize yourself with the nature of the work being performed. Be able to answer motorists' questions. Be aware of the work in progress.
12. Establish a warning signal with the work crew in case of an emergency.
13. Plan an escape route in case of an emergency.
14. Stay alert! Be ready to respond to an emergency.
15. Record the license number and description of any vehicle whose driver disobeys your instructions and threatens the safety of the work area. Report information to authorities.
16. Be courteous and professional.
17. Keep your mind on your job; do not do any other work when flagging.
18. Do not involve yourself in unnecessary conversation with workers, pedestrians, or motorists.
19. Do not leave your position until you are appropriately relieved.
20. Cover, turn or remove the "FLAGGER AHEAD" sign when a flagger is no longer on duty.
21. Always carry your flagger certification card while on the job.

Pedestrians, Bicycles and Other Roadway Users

Give consideration to pedestrian and bicycle traffic where appropriate. Provide alternative routes where designated walkways or bicycle routes are temporarily interrupted due to work operations. Alternative routes need to be free of obstructions and hazards (e.g., holes, debris, mud, construction and stored equipment, etc.). Clearly delineate all hazards near or adjacent to the path (e.g., ditches, trenches, excavations, etc.). Refer to MUTCD Part VI, Chapter 6D for additional requirements.

Pedestrians:

Most public highways and streets cannot deny access to pedestrians if no other route is available to them. All pre-existing ADA compliant pedestrian facilities within the work zone must continue to comply with ADA requirements for barrier-free access during work operations. Consider the following when addressing pedestrian issues within and around work zones:

- Pedestrians should not be led into conflicts with work site vehicles, equipment, and operations.

- Pedestrians should not be led into conflicts with vehicles moving through or around the work site.
- Pedestrians should be provided with a safe, convenient path that replicates as nearly as practical the most desirable characteristics of the existing sidewalks or a footpath.
- Pedestrians generally will not go out of their way. Make alternate pathways reasonable.
- Do not place signs and other traffic control devices within the pathway that may pose a hazard.
- **Placement of sidewalk closure signs shall be provided in advance of the closure point for pedestrians to make adjustments to their route. It must be recognized that pedestrians are reluctant to retrace their steps to a prior intersection for a crossing.**

Bicycles:

- Bicycles have a legal right of access to most highway facilities and provisions for their safe conduct through work zones are necessary.
- Provide and sign an appropriate alternate route when activities close a designated (signed) bicycle path or shoulder bikeway. Where horizontal separation for bicycles and pedestrians existed prior to work, give consideration to separating during work.
- When laying out alternative bicycle paths, make sure no overhead obstructions present a direct hazard to normal bicycle operation.
- Riding surfaces are important for safe bicycle operation. Loose gravel, uneven surfaces, milled pavement, and various asphaltic tack coats endanger the bicyclist. Consider the condition of the surface the bicyclist will be required to use.

Motorcycles:

The driving or roadway surface is also important for motorcycle rider safety. The same surfaces that are a problem for bicyclist are also difficult for motorcyclists. Stability at high speed is a far greater concern for motorcycles than cars on grooved pavement, milled asphalt and tapers from existing pavement down to milled surfaces. Adequate signing to warn for these conditions to alert the motorcycle rider are required. See TCD2, page 67, for a typical signing layout example.

Schools:

Work zone operations in the vicinity of schools require consideration to ensure that conflicts are kept to a minimum. Issues that should be considered are:

- Student path to and from the school
- Bus movements for loading and unloading students
- Coordination with crossing guards
- School hours to minimize impacts

Oversize Loads

Oversized vehicles may exceed the legal width, height, or weight limits for vehicles, but are still allowed to travel on certain state highways. Motor Carrier Services office issues permits that allow the oversized vehicles to use these routes and in some areas the region maintenance office also issues permits. If the proposed work zone will not accommodate over legal vehicles, then additional warning signs are necessary and notification of the motor carrier

services and the region's maintenance offices that issue these permits so they are aware of the restrictions. On some projects, it may be necessary to designate a detour route for oversized vehicles. A specific and specialized TCP should be considered to address oversize load conflicts and this information must be shared with the Motor Carrier Services office for their use in processing permits. Contact the region traffic office for assistance in determining and developing detour route plans.

Additional Work Zone Considerations

Work Zone Speed Limits

The speed limits on state highways are set by the State Traffic Engineer and cannot be changed without approval. Only use reduced legal speed limits when the safe operating speed of the roadway determines the need to do so. Safety issues such as access points, sight distance, poor roadway condition and reduced geometric features are some examples of issues that may apply. Speed reduction guidelines are outlined in RCW 47.48.020, the WSDOT Construction Manual (M41-01), and WSDOT Directive D55-20, "Reduced Speed in Maintenance and Construction Work Zones."

Do not reduce speed limits based on the hope that traffic will slow down when there is no driver perceived need to do so. Proposals to reduce the speed limit for work zones must be submitted to the region traffic office for consideration and Regional Administrator approval.

Worker Protection

Working on or along the highway can present a potentially hazardous work environment. Consider the risk to workers when developing the traffic control plans. See Appendix 5-5, page 91-93, WSDOT instructional letter for worker safety on paving projects. An assessment of worker safety should be made prior to beginning work operations.

Survey Work Zones

The guidance and tcp's contained in this guidebook do not reflect a specific type of work operation, which is consistent with the principles of Part VI of the MUTCD. It is intended that survey crews will follow the guidance shown in this guidebook to accommodate their work needs. Survey crews are not allowed any additional flexibility than other work crews to conduct work operations in a safe manner as intended within the established rules and guidance. However, tcp's more specific to survey operations may be considered. If specific plans are necessary or additional guidance is needed, contact the region traffic office for assistance.

Coordination

Accurate and timely reporting of work zone information to the public is a valuable element in the overall traffic control strategy. The use of public information resources, such as newspapers, radio and television can greatly improve the public's perception and acceptance of the necessary delays and other inconveniences caused by the project's construction. Issues to consider are:

- Emergency services coordination so they are aware of the project and can make adjustments to routes if necessary when responding to emergencies.
- Transit organizations, they may require adjustments to bus stop locations within project limits.
- Schools and local business, special considerations may be necessary for them to maintain access to their sites.
- Special events, be aware of special events that may conflict with the operation and make adjustments to work hours if necessary. Coordinate with event to minimize impacts. The region's public information officer can provide assistance in the coordination effort.

Road Closures

Closing a highway, street, or ramp, while not always practical, is a desirable option from a safety viewpoint. For the traveling public, closing the road for a short time might be less of an inconvenience than driving through a work zone for an extended period of time.

When it is necessary to close a road, street or ramp, submit a request to the region traffic office in advance of the need. Per RCW 47.48.010 and WSDOT Directive M55-20, the Regional Administrator may close a road, street, or ramp.

If a road closure is feasible, take the following actions:

- Obtain local agency approval; consult with region local programs office.
- Determine maximum number of days allowed for the closure.
- Determine if additional traffic control measures are needed at intersections on the detour route.
- Contact emergency services, schools, and transit organizations, etc.
- Coordinate with the region public information officer for assistance with public notification.

Short-term closures may be allowed without advance public notification for emergencies or off-peak closure (night closure). Check with the region traffic office prior to implementing a closure.

CHECKLIST FOR ESTABLISHING A TEMPORARY TRAFFIC CONTROL ZONE*

COMPLETED	ITEM
<input type="checkbox"/>	Determine the duration of work, (Stationary, Short-Duration, Mobile)*
<input type="checkbox"/>	Select hours of work to avoid peak periods (refer to region work hour chart when applicable)*
<input type="checkbox"/>	Select the appropriate layout(s), using duration, type of roadway, volume, and speed, from guidelines.
<input type="checkbox"/>	Determine any modifications to typical layout(s). <ul style="list-style-type: none">• Check decision sight distance• Include intersections and driveways• Allow for buffer space free of obstructions
<input type="checkbox"/>	Check the condition of devices (Refer to Quality Guidelines Booklet).
<input type="checkbox"/>	Install devices beginning with the first device the driver will see. Device spacing and layout as per chart shown on TCP's.
<input type="checkbox"/>	Conduct a drive through to check for problems.
<input type="checkbox"/>	Document temporary traffic control zone, problems and major modifications to the layouts.
<input type="checkbox"/>	Maintain devices while in place.
<input type="checkbox"/>	Remove the devices as soon as work is completed, beginning with the last device placed.

*Utilize the Region Traffic Office Staff to address concerns and questions.

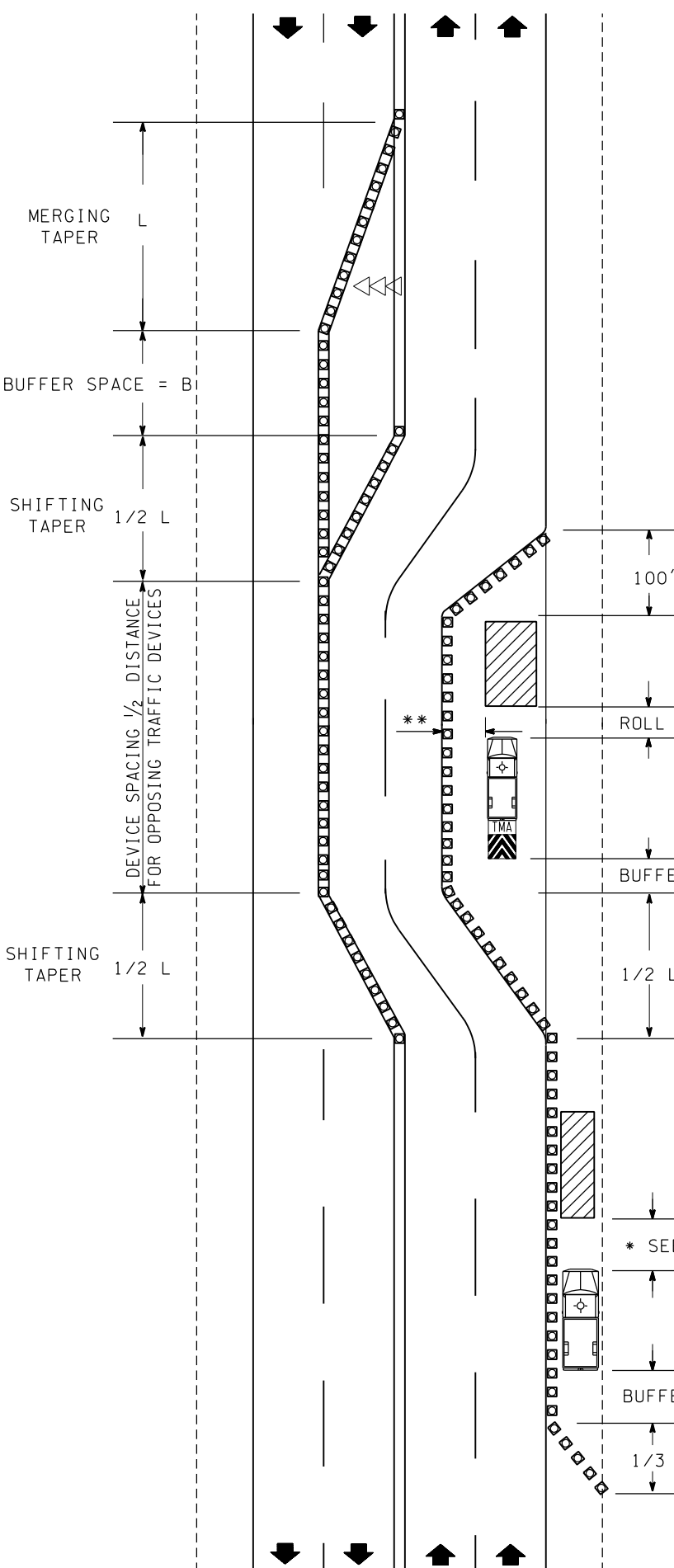

BUFFER DATA										
LONGITUDINAL BUFFER SPACE = B										
SPEED (MPH)	25	30	35	40	45	50	55	60	65	70
LENGTH (feet)	55	85	120	170	220	280	335	415	485	585
PROTECTIVE VEHICLE WITH TMA ROLL AHEAD DISTANCE										
TYPICAL PROTECTIVE VEHICLE TYPE WITH TMA	TYPICAL PROTECTIVE VEHICLE (WITH TMA) LOADED WEIGHT (LBS)						STATIONARY OPERATION (feet)			
4 YARD DUMP TRUCK, SERVICE TRUCK, FLAT BED, ETC.	MINIMUM WEIGHT 15,000 LBS. (MAXIMUM WEIGHT SHALL BE IN ACCORDANCE WITH MANUFACTURER RECOMMENDATION)						30 MIN.			
ROLL AHEAD STOPPING DISTANCE ASSUMES DRY PAVEMENT										
* A PROTECTIVE VEHICLE IS RECOMMENDED REGARDLESS IF A TMA IS AVAILABLE. IF NO TMA IS USED, THE PROTECTIVE VEHICLE SHALL BE STRATEGICALLY LOCATED IN THE FIELD TO SHIELD WORKERS AND NO ROLL AHEAD DISTANCE IS SPECIFIED.										

** LATERAL BUFFER SPACE
A LATERAL BUFFER SPACE OF 2 FEET IS RECOMMENDED FOR HIGH SPEED WORK ZONES.

CHANNELIZING DEVICE SPACING (FEET)		
MPH	TAPER	TANGENT
50/70	40	80
35/45	30	60
25/30	20	40

MINIMUM TAPER LENGTH (L) IN FEET										
Lane Width (feet)	Posted Speed (mph)									
	25	30	35	40	45	50	55	60	65	70
10	105	150	205	265	450	500	550	-	-	-
11	115	165	225	295	495	550	605	660	-	-
12	125	180	245	320	540	600	660	720	780	840

LEGEND

- SEQUENTIAL ARROW SIGN
- CHANNELIZING DEVICES
- PROTECTIVE VEHICLE WITHOUT TMA - RECOMMENDED
- PROTECTIVE VEHICLE WITH TMA - RECOMMENDED

TAPER AND BUFFER SPACE DETAILS

TAPER / CHANNELIZING DEVICE TABLE

MERGING, SHIFTING & SHOULDER TAPER LENGTHS
AND NUMBER OF CHANNELIZATION DEVICES USED

(All minimums)

Lane Width	10 Feet				11 Feet				12 Feet				Shoulder Tapers (Assumes 10' Shoulders)		
	L		1/2 L		L		1/2 L		L		1/2 L		*1/3L		
MPH	Merging	Devices	Shifting	Devices	Merging	Devices	Shifting	Devices	Merging	Devices	Shifting	Devices	MPH	(ft) Length	Devices
20	70	6	35	3	75	6	40	3	80	6	40	3	20	25	3
25	105	6	55	4	115	7	60	4	125	7	65	4	25	35	3
30	150	8	75	5	165	9	85	5	180	10	90	5	30	50	3
35	205	8	105	5	225	9	115	5	245	9	125	5	35	70	4
40	270	10	135	6	295	11	150	6	320	12	160	6	40	90	4
45	450	16	225	9	495	18	250	9	540	19	270	10	45	150	6
50	500	14	250	8	550	15	275	8	600	16	300	9	50	170	6
55	550	15	275	8	605	16	305	9	660	18	330	9	55	185	6
60	600	16	300	9	660	18	330	9	720	19	360	10	60	200	6
65	650	17	325	9	715	19	370	10	780	21	390	11	65	220	7
70	700	19	350	10	770	20	385	11	840	22	420	12	70	235	7

**L for shoulder taper equals
Shoulder Width x Speed.
Figures shown are for a
10' shoulder.*

** The number of channelizing devices listed is the minimum required. Use of more devices should be considered if additional delineation is desired.

STATIONARY WORK ZONES

Traffic Control Plans (TCP's) 1 to 13

Stationary work zones are used for work activities that exceed one hour but could last for several days. Signs and channelizing devices are required for stationary work zones. Devices, such as sequential arrow panels, barricades and protective vehicles, may also be used depending on the situation. For longer term projects, temporary concrete barriers or water filled barriers, temporary pavement markings and post mounted signs might be typical devices. Examples of stationary work zone operations include: light standard repair, paving, sign installation and bridge repair. Stationary work zone traffic control is usually associated with a substantial work operation that may have many workers, equipment, truck hauling and flagging. Traffic operation, all work activities, workers and flaggers must be incorporated into the work zone and provided for during planning and selecting the Traffic Control Plans (TCP's).

The following TCP's show typical stationary traffic control setups.

END ROAD WORK

G20-2A
48"x24"
B/O

down stream taper to show end of work area

SIGN SPACING = X (feet)		
Rural Highways	60/65 MPH	1000'+-
Rural Roads	45/55 MPH	500'+-
Rural Roads & Urban Arterials	35/40 MPH	350'+-
Rural Roads, Urban Streets Residential & Business Districts	25/30 MPH	200'+-
Urban Streets	25 MPH or LESS	100'+-

ALL SIGNS ARE 48" x 48" BLACK ON ORANGE UNLESS OTHERWISE DESIGNATED.
All spacing may be adjusted to accommodate interchange ramps, at-grade intersections, and driveways.

BUFFER DATA										
LONGITUDINAL BUFFER SPACE = B										
SPEED (MPH)	25	30	35	40	45	50	55	60	65	70
LENGTH (feet)	55	85	120	170	220	280	335	415	-	-
PROTECTIVE VEHICLE WITH TMA ROLL AHEAD DISTANCE										
TYPICAL PROTECTIVE VEHICLE TYPE WITH TMA	TYPICAL PROTECTIVE VEHICLE (WITH TMA) LOADED WEIGHT (LBS)							STATIONARY OPERATION (feet)		
4 YARD DUMP TRUCK, SERVICE TRUCK, FLAT BED, ETC.	MINIMUM WEIGHT 15,000 LBS. (MAXIMUM WEIGHT SHALL BE IN ACCORDANCE WITH MANUFACTURER RECOMMENDATION)							30 MIN.		
ROLL AHEAD STOPPING DISTANCE ASSUMES DRY PAVEMENT										
• A PROTECTIVE VEHICLE IS RECOMMENDED REGARDLESS IF A TMA IS AVAILABLE. IF NO TMA IS USED, THE PROTECTIVE VEHICLE SHALL BE STRATEGICALLY LOCATED IN THE FIELD TO SHIELD WORKERS AND NO ROLL AHEAD DISTANCE IS SPECIFIED.										

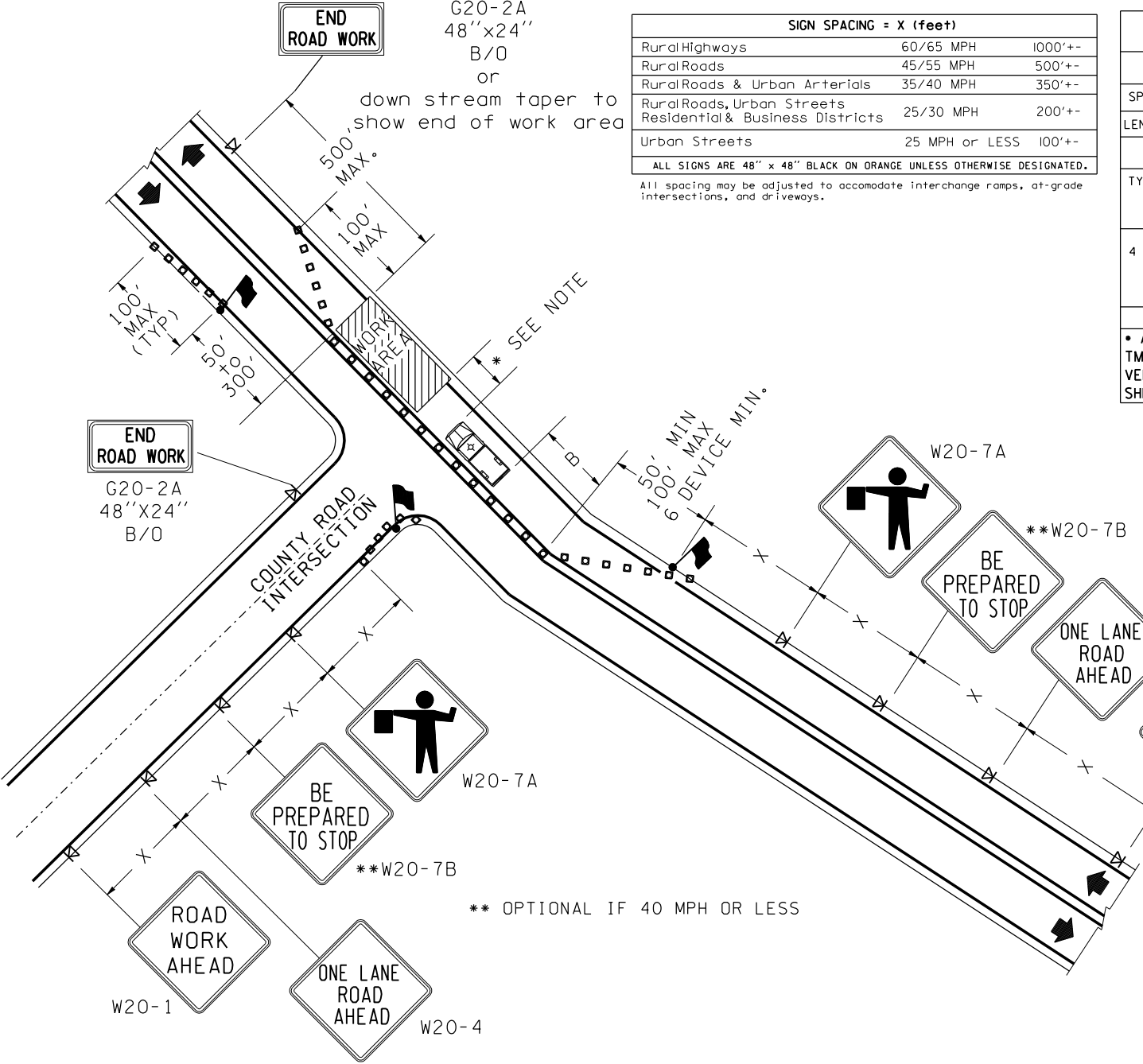

CHANNELIZING DEVICE SPACING (FEET)		
MPH	TAPER	TANGENT
50/65	40	80
35/45	30	60
25/30	20	40

LEGEND

- FLAGGING STATION
- SIGN LOCATION
- CHANNELIZING DEVICES
- PROTECTIVE VEHICLE - RECOMMENDED



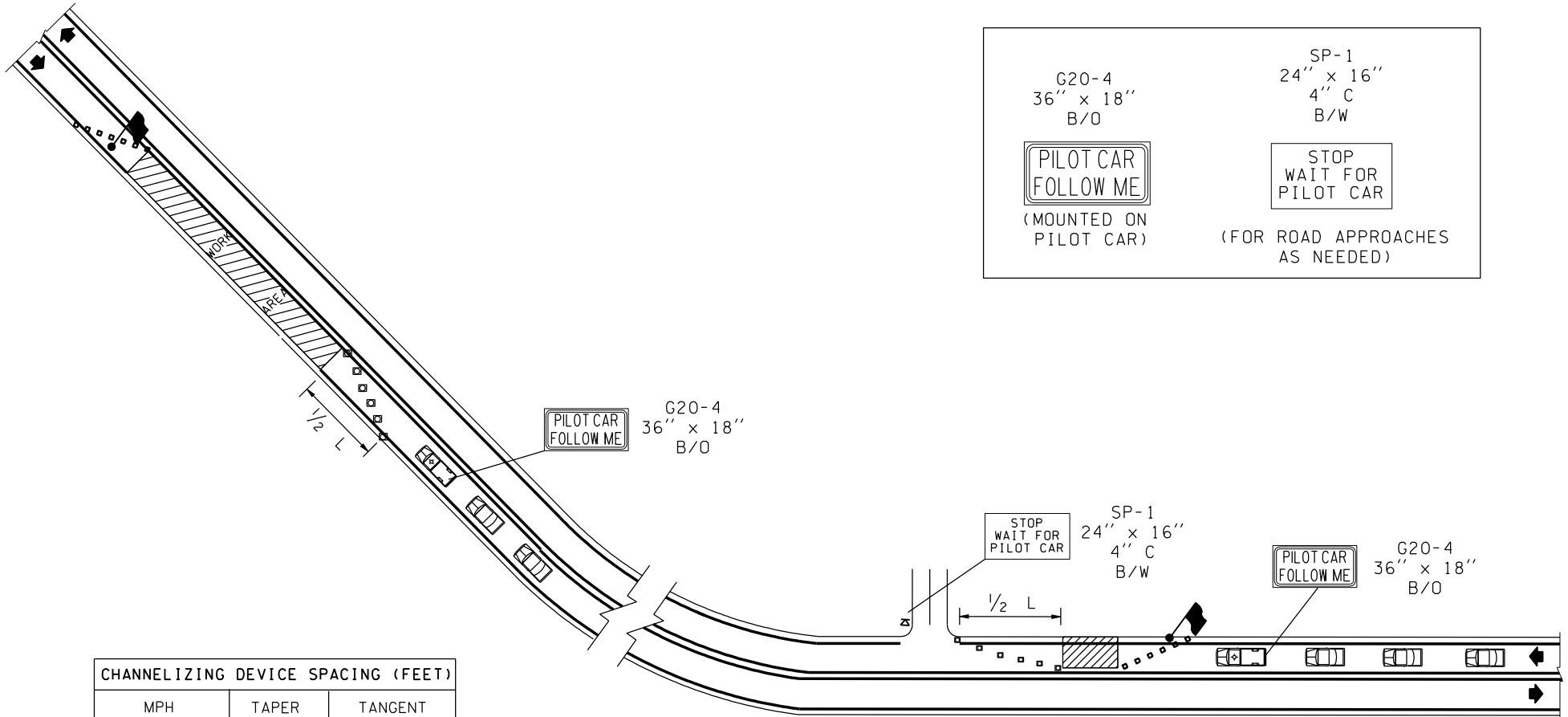

**ALTERNATING ONE-WAY TRAFFIC
FLAGGER CONTROLLED
TCP 1**

GENERAL NOTES

1. NIGHTWORK REQUIRES ADDITIONAL ROADWAY LIGHTING AT FLAGGING STATIONS, REFER TO WSDOT STD. SPECIFICATIONS FOR ADDITIONAL DETAILS.
2. RECOMMEND EXTENDING CHANNELIZING DEVICE TAPER ACROSS SHOULDER.
4. PROTECTIVE VEHICLE RECOMMENDED - MAY BE A WORK VEHICLE.
5. SIGN SEQUENCE IS THE SAME FOR BOTH DIRECTIONS OF TRAVEL ON THE ROADWAY.



LEGEND

-  FLAGGING STATION
-  SIGN LOCATION
-  CHANNELIZING DEVICES
-  PILOT VEHICLE
-  MOTORIST VEHICLE

GENERAL NOTES

1. REFER TO SHEET TCP1 FOR ADDITIONAL SIGNING AND FLAGGING DETAILS NOT SHOWN.
2. CHANNELIZING DEVICES ARE RECOMMENDED ALONG CENTERLINE TO SEPARATE TRAFFIC FROM WORK OPERATION. DEVICES ARE REQUIRED AT TAPERS TO SHIFT TRAFFIC MOVEMENT BETWEEN LANES AND TO PROTECT ALL FLAGGING STATIONS.

BUFFER DATA										
LONGITUDINAL BUFFER SPACE = B										
SPEED (MPH)	25	30	35	40	45	50	55	60	65	70
LENGTH (feet)	55	85	120	170	220	280	335	415	485	585
PROTECTIVE VEHICLE WITH TMA ROLL AHEAD DISTANCE										
TYPICAL PROTECTIVE VEHICLE TYPE WITH TMA	TYPICAL PROTECTIVE VEHICLE (WITH TMA) LOADED WEIGHT (LBS)						STATIONARY OPERATION (feet)			
4 YARD DUMP TRUCK, SERVICE TRUCK, FLAT BED, ETC.	MINIMUM WEIGHT 15,000 LBS. (MAXIMUM WEIGHT SHALL BE IN ACCORDANCE WITH MANUFACTURER RECOMMENDATION)						30 MIN.			
ROLL AHEAD STOPPING DISTANCE ASSUMES DRY PAVEMENT										
• A PROTECTIVE VEHICLE IS RECOMMENDED REGARDLESS IF A TMA IS AVAILABLE. IF NO TMA IS USED, THE PROTECTIVE VEHICLE SHALL BE STRATEGICALLY LOCATED IN THE FIELD TO SHIELD WORKERS AND NO ROLL AHEAD DISTANCE IS SPECIFIED.										

LANE WIDTH (feet)	MINIMUM TAPER LENGTH = L (feet)									
	Posted Speed (mph)									
25	30	35	40	45	50	55	60	65	70	
10	105	150	205	270	450	500	550	-	-	-
11	115	165	225	295	495	550	605	660	-	-
12	125	180	245	320	540	600	660	720	780	840

CHANNELIZING DEVICE SPACING (FEET)		
MPH	TAPER	TANGENT
50/70	40	80
35/45	30	60
25/30	20	40

SIGN SPACING = X (feet)		
Freeways & Expressways	55/70 MPH	1500'+- (OR AS PER MUTCD)
Rural Highways	60/65 MPH	1000'+-
Rural Roads	45/55 MPH	500'+-
Rural Roads & Urban Arterials	35/40 MPH	350'+-
Rural Roads, Urban Streets Residential & Business Districts	25/30 MPH	200'+-
Urban Streets	25 MPH or LESS	100'+-
ALL SIGNS ARE 48" x 48" BLACK ON ORANGE UNLESS OTHERWISE DESIGNATED.		

All spacing may be adjusted to accommodate interchange ramps, at-grade intersections, and driveways.

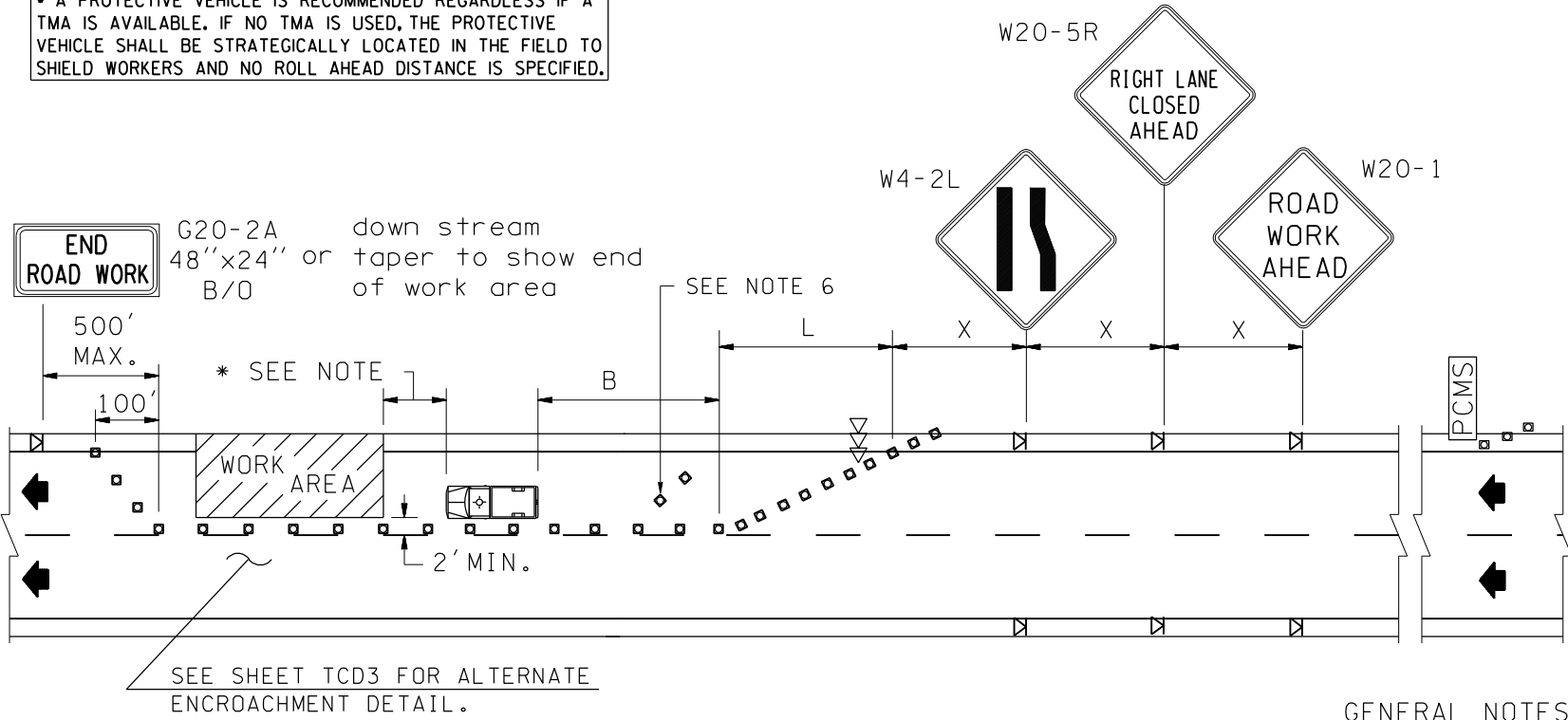

(SAMPLE MESSAGE)

PCMS	
1	2
LANE CLOSED	1 MILE AHEAD
1.5 SEC	1.5 SEC

Field locate 1 mile +- in advance of lane closure.

GENERAL NOTES

1. PROTECTIVE VEHICLE RECOMMENDED - MAY BE A WORK VEHICLE.
2. CONTACT REGION TRAFFIC OFFICE FOR WORK HOUR RESTRICTIONS.
3. RECOMMEND EXTENDING DEVICE TAPER ACROSS SHOULDER. (L/3 TAPER)
4. DEVICES SHOULD NOT ENCROACH INTO ADJACENT LANES.
5. PCMS RECOMMENDED.
6. USE TRANSVERSE DEVICES IN CLOSED LANE EVERY 1000' +- (RECOMMENDED).
7. TRAFFIC SAFETY DRUMS RECOMMENDED FOR ALL TAPERS ON HIGH SPEED ROADWAYS. (SEE DEVICE MATRIX)

LEGEND

- SIGN LOCATION
- SEQUENTIAL ARROW SIGN
- □ □ CHANNELIZING DEVICES
- 🚚 PROTECTIVE VEHICLE - RECOMMENDED
- PCMS PORTABLE CHANGEABLE MESSAGE SIGN

SINGLE-LANE CLOSURE FOR MULTI-LANE ROADWAYS TCP 3

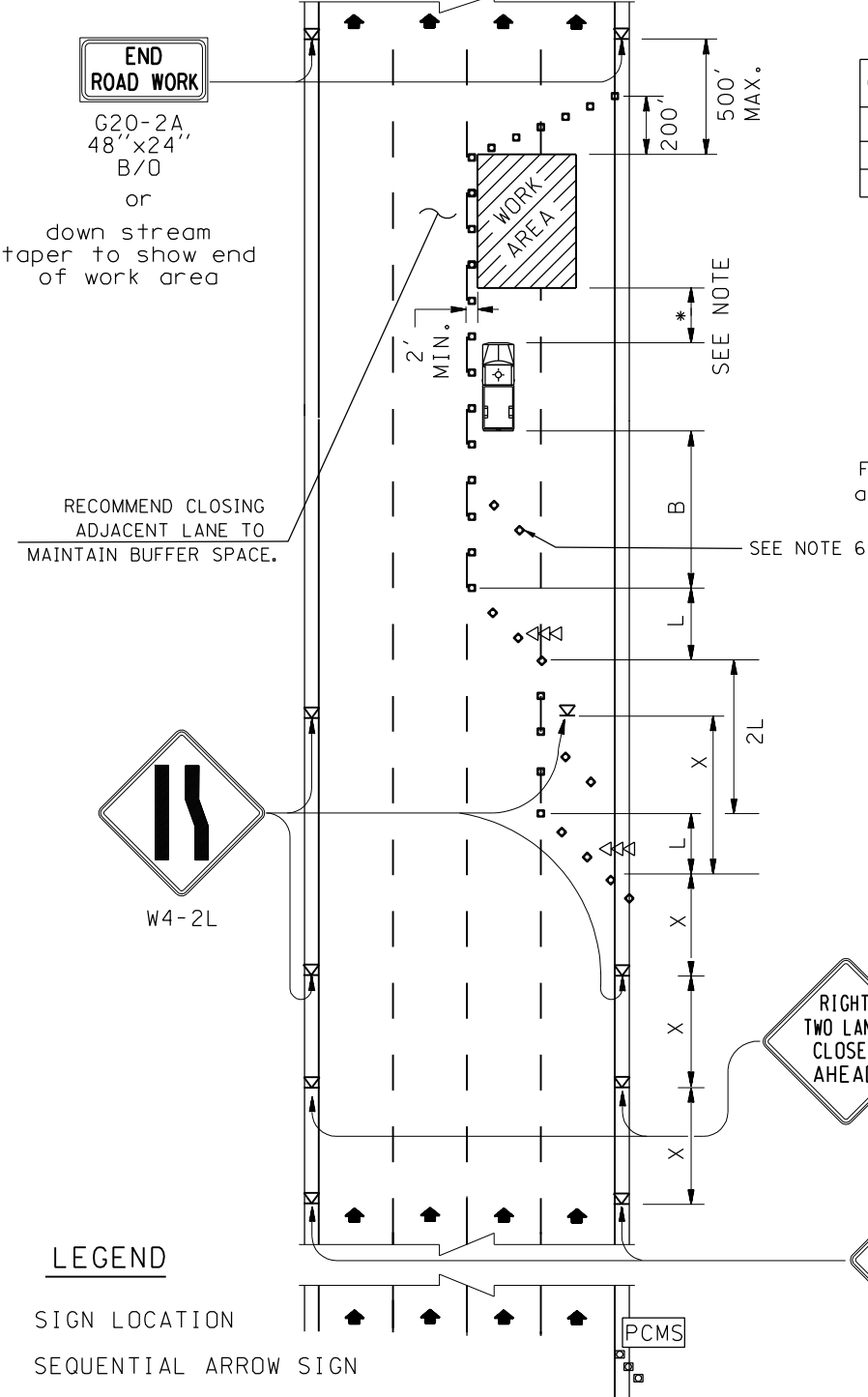

MPH	TAPER	TANGENT
50/70	40	80
40/45	30	60

(SAMPLE MESSAGE)

PCMS	
1	2
2 LANES CLOSED	1 MILE AHEAD
1.5 SEC	1.5 SEC

Field locate 1 mile +/- in advance of lane closure.

LONGITUDINAL BUFFER SPACE = B										
SPEED (MPH)	25	30	35	40	45	50	55	60	65	70
LENGTH (feet)	55	85	120	170	220	280	335	415	485	585
PROTECTIVE VEHICLE WITH TMA ROLL AHEAD DISTANCE										
TYPICAL PROTECTIVE VEHICLE TYPE WITH TMA	TYPICAL PROTECTIVE VEHICLE (WITH TMA) LOADED WEIGHT (LBS)							STATIONARY OPERATION (feet)		
4 YARD DUMP TRUCK, SERVICE TRUCK, FLAT BED, ETC.	MINIMUM WEIGHT 15,000 LBS. (MAXIMUM WEIGHT SHALL BE IN ACCORDANCE WITH MANUFACTURER RECOMMENDATION)							30 MIN.		
ROLL AHEAD STOPPING DISTANCE ASSUMES DRY PAVEMENT										
<ul style="list-style-type: none"> A PROTECTIVE VEHICLE IS RECOMMENDED REGARDLESS IF A TMA IS AVAILABLE. IF NO TMA IS USED, THE PROTECTIVE VEHICLE SHALL BE STRATEGICALLY LOCATED IN THE FIELD TO SHIELD WORKERS AND NO ROLL AHEAD DISTANCE IS SPECIFIED. 										

Lane Width (feet)	Posted Speed (mph)									
	25	30	35	40	45	50	55	60	65	70
10	-	-	-	265	450	500	550	-	-	-
11	-	-	-	295	495	550	605	660	-	-
12	-	-	-	320	540	600	660	720	780	840

Freeways & Expressways	55/70 MPH	1500'+- (OR AS PER MUTCD)
Rural Highways	60/65 MPH	1000'+-
Rural Roads	45/55 MPH	500'+-
Rural Roads & Urban Arterials	35/40 MPH	350'+-
Rural Roads, Urban Streets Residential & Business Districts	25/30 MPH	200'+-
Urban Streets	25 MPH or LESS	100'+-

ALL SIGNS ARE 48" x 48" BLACK ON ORANGE UNLESS OTHERWISE DESIGNATED.

All spacing may be adjusted to accommodate interchange ramps, at-grade intersections, and driveways.

GENERAL NOTES

1. PROTECTIVE VEHICLE RECOMMENDED - MAY BE A WORK VEHICLE.
2. CONTACT REGION TRAFFIC OFFICE FOR WORK HOUR RESTRICTIONS.
3. RECOMMEND EXTENDING DEVICE TAPER ACROSS SHOULDER. (L/3 TAPER)
4. DEVICES SHOULD NOT ENCRoACH INTO ADJACENT LANES.
5. PCMS RECOMMENDED.
6. USE TRANSVERSE DEVICES IN CLOSED LANE EVERY 1000'+- (RECOMMENDED).
7. TRAFFIC SAFETY DRUMS RECOMMENDED FOR ALL TAPERS ON HIGH SPEED ROADWAYS. (SEE DEVICE MATRIX)

DOUBLE-LANE CLOSURE FOR MULTI-LANE ROADWAYS TCP 4

BUFFER DATA										
LONGITUDINAL BUFFER SPACE = B										
SPEED (MPH)	25	30	35	40	45	50	55	60	65	70
LENGTH (feet)	55	85	120	170	-	-	-	-	-	-
PROTECTIVE VEHICLE WITH TMA ROLL AHEAD DISTANCE										
TYPICAL PROTECTIVE VEHICLE TYPE WITH TMA	TYPICAL PROTECTIVE VEHICLE (WITH TMA) LOADED WEIGHT (LBS)						STATIONARY OPERATION (feet)			
4 YARD DUMP TRUCK, SERVICE TRUCK, FLAT BED, ETC.	MINIMUM WEIGHT 15,000 LBS. (MAXIMUM WEIGHT SHALL BE IN ACCORDANCE WITH MANUFACTURER RECOMMENDATION)						30' MIN			
ROLL AHEAD STOPPING DISTANCE ASSUMES DRY PAVEMENT										
• A PROTECTIVE VEHICLE IS RECOMMENDED REGARDLESS IF A TMA IS AVAILABLE. IF NO TMA IS USED, THE PROTECTIVE VEHICLE SHALL BE STRATEGICALLY LOCATED IN THE FIELD TO SHIELD WORKERS AND NO ROLL AHEAD DISTANCE IS SPECIFIED.										

SIGN SPACING = X (FEET)			
Rural Roads & Urban Arterials	35/40 MPH	350'++	
Rural Roads, Urban Streets Residential Business Districts	25/30 MPH	200'++	
Urban Streets	25 MPH or LESS	100'++	
All signs are 48"x48" black on orange unless otherwise designated.			

Shoulder Width (feet)	MINIMUM SHOULDER TAPER LENGTH IN FEET (L)									
	Posted Speed (mph)									
	25	30	35	40	45	50	55	60	65	70
6	63	90	123	165	-	-	-	-	-	-
8	84	120	162	210	-	-	-	-	-	-
10	105	150	204	270	-	-	-	-	-	-
3 DEVICES MINIMUM SPACED 10' O.C. IN TAPERS FOR SHOULDER WIDTHS LESS THAN 6 FEET										

CHANNELIZING DEVICE SPACING (FEET)		
MPH	TAPER	TANGENT
35/40	30	60
25/30	20	40

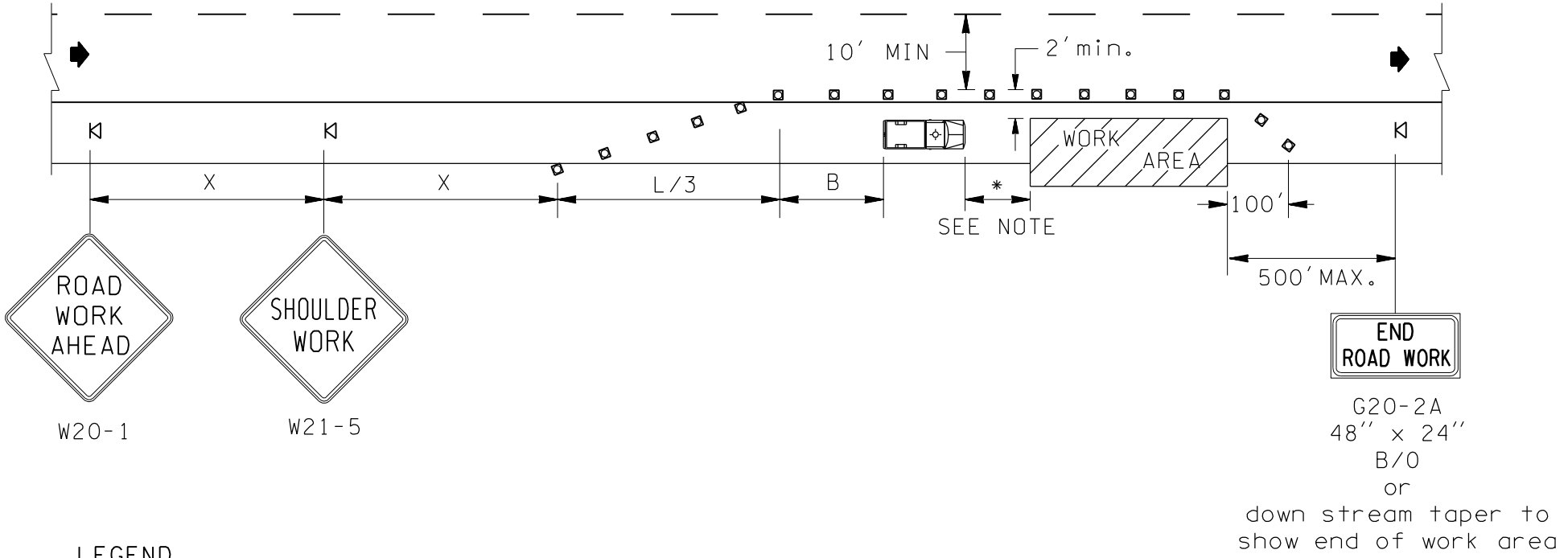

LEGEND

- ⋈ SIGN LOCATION
- □ □ CHANNELIZING DEVICES
- PROTECTIVE VEHICLE - RECOMMENDED

GENERAL NOTES

1. PROTECTIVE VEHICLE RECOMMENDED - MAY BE A WORK VEHICLE.

SHOULDER CLOSURE - LOW SPEED
TCP 5

BUFFER DATA										
LONGITUDINAL BUFFER SPACE = B										
SPEED (MPH)	25	30	35	40	45	50	55	60	65	70
LENGTH (feet)	-	-	-	-	220	280	335	415	485	585
PROTECTIVE VEHICLE WITH TMA ROLL AHEAD DISTANCE										
TYPICAL PROTECTIVE VEHICLE TYPE WITH TMA	TYPICAL PROTECTIVE VEHICLE (WITH TMA) LOADED WEIGHT (LBS)							STATIONARY OPERATION (feet)		
4 YARD DUMP TRUCK, SERVICE TRUCK, FLAT BED, ETC.	MINIMUM WEIGHT 15,000 LBS. (MAXIMUM WEIGHT SHALL BE IN ACCORDANCE WITH MANUFACTURER RECOMMENDATION)							30 MIN		
ROLL AHEAD STOPPING DISTANCE ASSUMES DRY PAVEMENT										
• A PROTECTIVE VEHICLE IS RECOMMENDED REGARDLESS IF A TMA IS AVAILABLE. IF NO TMA IS USED, THE PROTECTIVE VEHICLE SHALL BE STRATEGICALLY LOCATED IN THE FIELD TO SHIELD WORKERS AND NO ROLL AHEAD DISTANCE IS SPECIFIED.										

CHANNELIZING DEVICE SPACING (FEET)		
MPH	TAPER	TANGENT
50/70	40	80
45/50	30	60

MINIMUM SHOULDER TAPER LENGTH IN FEET (L)										
Shoulder Width (feet)	Posted Speed (mph)									
	25	30	35	40	45	50	55	60	65	70
6	-	-	-	-	270	300	330	360	390	420
8	-	-	-	-	360	405	450	480	525	570
10	-	-	-	-	450	510	555	600	660	705
3 DEVICES MINIMUM SPACED 10' O.C. IN TAPERS FOR SHOULDER WIDTHS LESS THAN 6 FEET										

SIGN SPACING = X (feet)		
Freeways & Expressways	55/70 MPH	1500'+- (OR AS PER MUTCD)
Rural Highways	60/65 MPH	1000'+-
Rural Roads	45/55 MPH	500'+-
ALL SIGNS ARE 48" x 48" BLACK ON ORANGE UNLESS OTHERWISE DESIGNATED.		

All spacing may be adjusted to accommodate interchange ramps, at-grade intersections, and driveways.

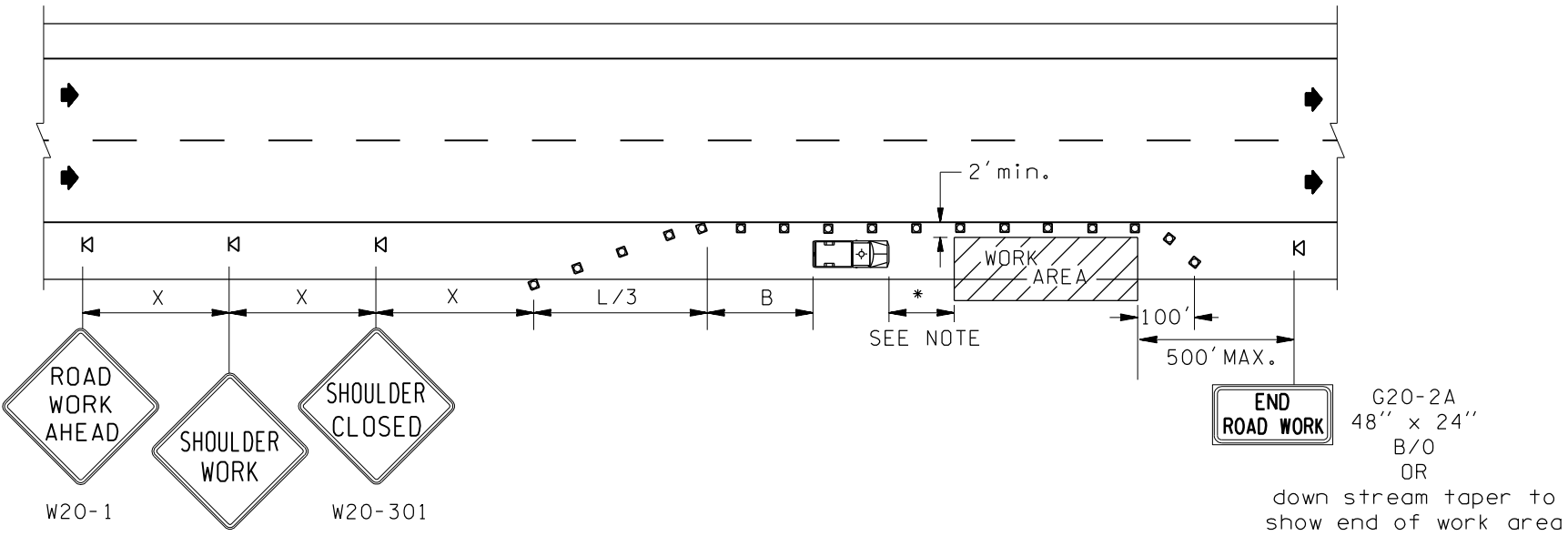

LEGEND

- ⊠ SIGN LOCATION
- □ □ CHANNELIZING DEVICES
- 🚚 PROTECTIVE VEHICLE - RECOMMENDED

GENERAL NOTES

1. NO ENCROACHMENT ON TRAVELED LANE. IF ENCROACHMENT IS NECESSARY, LANE SHALL BE CLOSED.
2. PROTECTIVE VEHICLE RECOMMENDED - MAY BE A WORK VEHICLE.

**SHOULDER CLOSURE - HIGH SPEED
TCP 6**

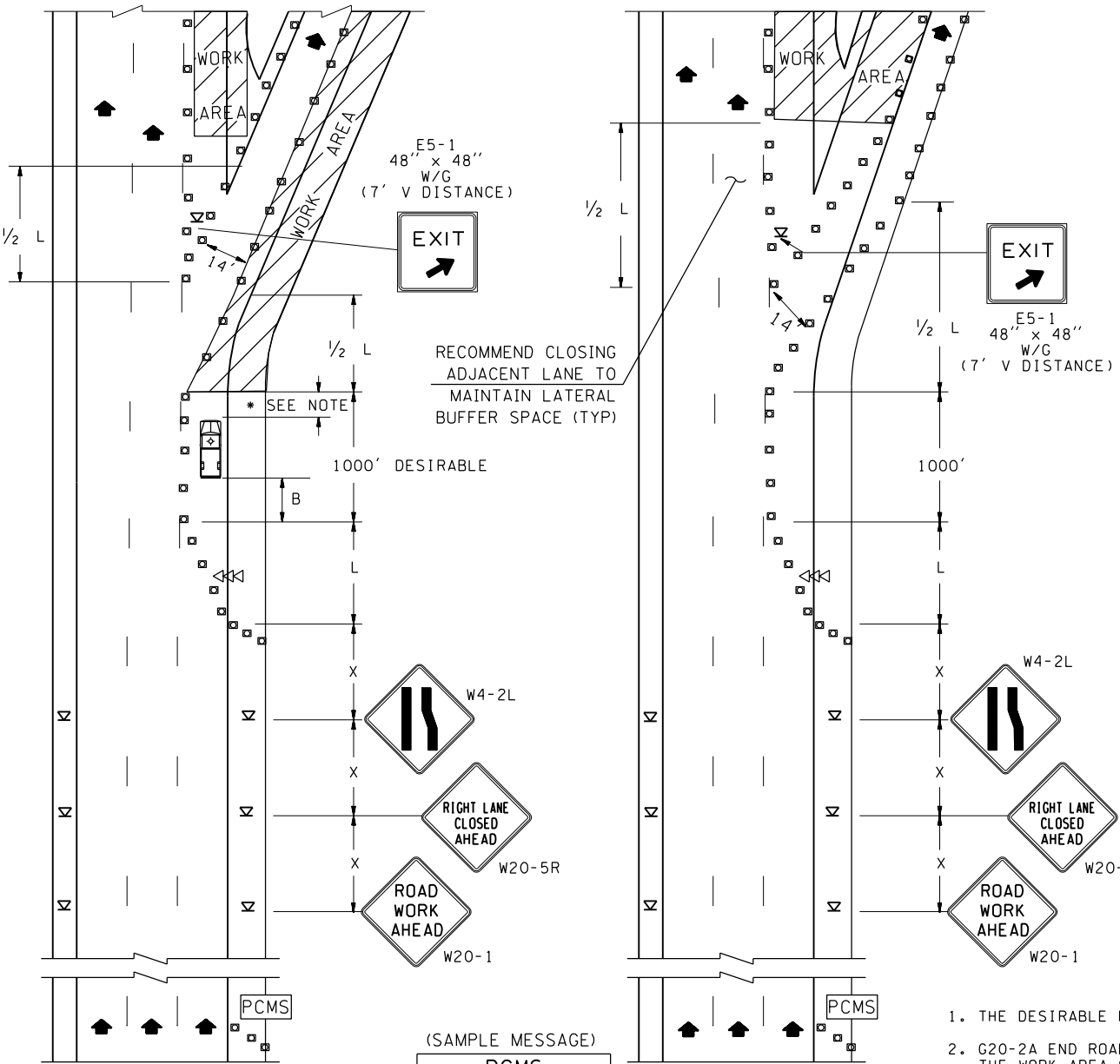

LEGEND

- ⊗ SIGN LOCATION
- ▷▷ SEQUENTIAL ARROW SIGN
- □ □ CHANNELIZING DEVICES
- ☐ PROTECTIVE VEHICLE - RECOMMENDED
- PCMS PORTABLE CHANGEABLE MESSAGE SIGN (RECOMMENDED)

(SAMPLE MESSAGE)

PCMS	
1	2
LANE CLOSED	1 MILE AHEAD
1.5 SEC	1.5 SEC

Field locate 1 mile +/- in advance of lane closure.

BUFFER DATA

LONGITUDINAL BUFFER SPACE = B										
SPEED (MPH)	25	30	35	40	45	50	55	60	65	70
LENGTH (feet)	55	85	120	170	220	280	335	415	485	585
PROTECTIVE VEHICLE WITH TMA ROLL AHEAD DISTANCE										
TYPICAL PROTECTIVE VEHICLE TYPE WITH TMA	4 YARD DUMP TRUCK, SERVICE TRUCK, FLAT BED, ETC.						TYPICAL PROTECTIVE VEHICLE (WITH TMA) LOADED WEIGHT (LBS)			STATIONARY OPERATION (feet)
						MINIMUM WEIGHT 15,000 LBS. (MAXIMUM WEIGHT SHALL BE IN ACCORDANCE WITH MANUFACTURER RECOMMENDATION)			30 MIN.	
ROLL AHEAD STOPPING DISTANCE ASSUMES DRY PAVEMENT										
<ul style="list-style-type: none"> A PROTECTIVE VEHICLE IS RECOMMENDED REGARDLESS IF A TMA IS AVAILABLE. IF NO TMA IS USED, THE PROTECTIVE VEHICLE SHALL BE STRATEGICALLY LOCATED IN THE FIELD TO SHIELD WORKERS AND NO ROLL AHEAD DISTANCE IS SPECIFIED. 										

MINIMUM TAPER LENGTH = L (feet)

LANE WIDTH (feet)	Posted Speed (mph)									
	25	30	35	40	45	50	55	60	65	70
10	-	-	-	270	450	500	550	-	-	-
11	-	-	-	295	495	550	605	660	-	-
12	-	-	-	320	540	600	660	720	780	840

SIGN SPACING = X (feet)

Freeways & Expressways	55/70 MPH	1500'+- (OR AS PER MUTCD)
Rural Highways	60/65 MPH	1000'+-
Rural Roads	45/55 MPH	500'+-
Rural Roads & Urban Arterials	35/40 MPH	350'+-

ALL SIGNS ARE 48" x 48" BLACK ON ORANGE UNLESS OTHERWISE DESIGNATED.
All spacing may be adjusted to accommodate interchange ramps, at-grade intersections, and driveways.

CHANNELIZING DEVICE SPACING (FEET)

MPH	TAPER	TANGENT
50/70	40	80
40/45	30	60

GENERAL NOTES

- THE DESIRABLE RAMP WIDTH IS 14' AND A 20:1 RAMP TAPER.
- G20-2A END ROAD WORK SIGN SHOULD BE INSTALLED 500' BEYOND THE WORK AREA OR USE A DOWN STREAM TAPER.
- CONTACT REGION TRAFFIC OFFICE FOR WORK HOURS RESTRICTIONS.
- PROTECTIVE VEHICLE RECOMMENDED - MAY BE A WORK VEHICLE.
- RECOMMEND EXTENDING CHANNELIZATION DEVICE TAPER ACROSS SHOULDER. (L/3 TAPER)
- DEVICES SHOULD NOT ENCR OACH INTO ADJACENT LANES.
- TRAFFIC SAFETY DRUMS RECOMMENDED FOR ALL TAPERS ON HIGH SPEED ROADWAYS. (SEE DEVICE MATRIX)
- USE TRANSVERSE DEVICES IN CLOSED LANE EVERY 1000' +- (RECOMMENDED)
- CONSIDER SHORT TERM CLOSURE OF RAMP.

TEMPORARY OFF-RAMP FOR MULTI-LANE ROADWAYS
TCP 7

BUFFER DATA										
LONGITUDINAL BUFFER SPACE = B										
SPEED (MPH)	25	30	35	40	45	50	55	60	65	70
LENGTH (feet)	55	85	120	170	220	280	335	415	485	585
PROTECTIVE VEHICLE WITH TMA ROLL AHEAD DISTANCE										
TYPICAL PROTECTIVE VEHICLE TYPE WITH TMA	TYPICAL PROTECTIVE VEHICLE (WITH TMA) LOADED WEIGHT (LBS)						STATIONARY OPERATION (feet)			
4 YARD DUMP TRUCK, SERVICE TRUCK, FLAT BED, ETC.	MINIMUM WEIGHT 15,000 LBS. (MAXIMUM WEIGHT SHALL BE IN ACCORDANCE WITH MANUFACTURER RECOMMENDATION)						30 MIN.			
ROLL AHEAD STOPPING DISTANCE ASSUMES DRY PAVEMENT										
<ul style="list-style-type: none"> A PROTECTIVE VEHICLE IS RECOMMENDED REGARDLESS IF A TMA IS AVAILABLE. IF NO TMA IS USED, THE PROTECTIVE VEHICLE SHALL BE STRATEGICALLY LOCATED IN THE FIELD TO SHIELD WORKERS AND NO ROLL AHEAD DISTANCE IS SPECIFIED. 										

SIGN SPACING = X (feet)		
Freeways & Expressways	55/70 MPH	1500'+- (OR AS PER MUTCD)
Rural Highways	60/65 MPH	1000'+-
Rural Roads	45/55 MPH	500'+-
Rural Roads & Urban Arterials	35/40 MPH	350'+-
ALL SIGNS ARE 48" x 48" BLACK ON ORANGE UNLESS OTHERWISE DESIGNATED.		

All spacing may be adjusted to accommodate interchange ramps, at-grade intersections, and driveways.

CHANNELIZING DEVICE SPACING (FEET)		
MPH	TAPER	TANGENT
50/70	40	80
40/45	30	60

SEE SHEET TCD3 FOR ALTERNATE ENCROACHMENT DETAIL.

MINIMUM TAPER LENGTH = L (feet)										
LANE WIDTH (feet)	Posted Speed (mph)									
	25	30	35	40	45	50	55	60	65	70
10	-	-	-	270	450	500	550	-	-	-
11	-	-	-	295	495	550	605	660	-	-
12	-	-	-	320	540	600	660	720	780	840

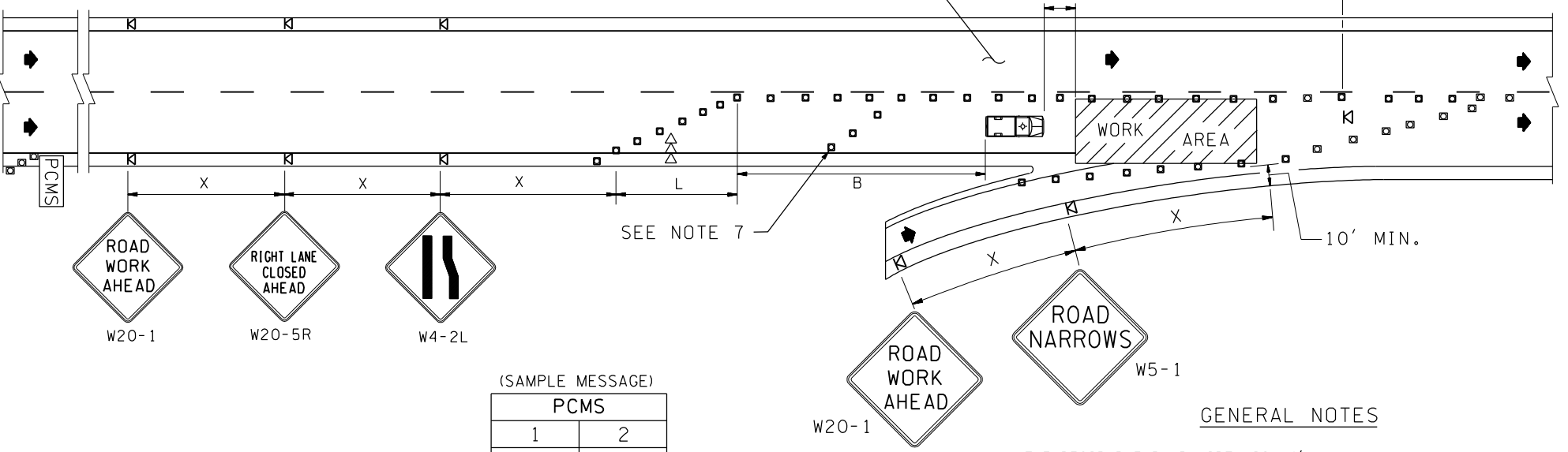

(SAMPLE MESSAGE)

PCMS	
1	2
LANE CLOSED	1 MILE AHEAD
1.5 SEC	1.5 SEC

Field locate 1 mile +- in advance of lane closure.

LEGEND

- SIGN LOCATION
- SEQUENTIAL ARROW SIGN
- CHANNELIZING DEVICES
- PROTECTIVE VEHICLE - RECOMMENDED
- PORTABLE CHANGEABLE MESSAGE SIGN (RECOMMENDED)

GENERAL NOTES

1. THE DESIRABLE RAMP WIDTH IS 14'.
2. A G20-2A END ROAD WORK SIGN SHOULD BE INSTALLED 500' BEYOND THE WORK AREA OR USE A DOWN STREAM TAPER.
3. CONTACT REGION TRAFFIC OFFICE FOR WORK HOUR RESTRICTIONS.
4. PROTECTIVE VEHICLE RECOMMENDED - MAY BE A WORK VEHICLE.
5. RECOMMEND EXTENDING CHANNELIZATION DEVICE TAPER ACROSS SHOULDER (L/3 TAPER)
6. TRAFFIC SAFETY DRUMS RECOMMENDED FOR ALL TAPERS ON HIGH SPEED ROADWAYS. (SEE DEVICE MATRIX)
7. USE TRANSVERSE DEVICES IN CLOSED LANE EVERY 1000'+-. (RECOMMENDED)
8. DEVICES SHOULD NOT ENCROACH INTO ADJACENT LANES.
9. CONSIDER SHORT DURATION CLOSURE OF RAMP.

TEMPORARY ON-RAMP FOR MULTI-LANE ROADWAYS TCP 8

BUFFER DATA										
LONGITUDINAL BUFFER SPACE = B										
SPEED (MPH)	25	30	35	40	45	50	55	60	65	70
LENGTH (feet)	55	85	120	170	220	280	335	415	485	585
PROTECTIVE VEHICLE WITH TMA ROLL AHEAD DISTANCE										
TYPICAL PROTECTIVE VEHICLE TYPE WITH TMA	TYPICAL PROTECTIVE VEHICLE (WITH TMA) LOADED WEIGHT (LBS)							STATIONARY OPERATION (feet)		
4 YARD DUMP TRUCK, SERVICE TRUCK, FLAT BED, ETC.	MINIMUM WEIGHT 15,000 LBS. (MAXIMUM WEIGHT SHALL BE IN ACCORDANCE WITH MANUFACTURER RECOMMENDATION)							30 MIN.		
ROLL AHEAD STOPPING DISTANCE ASSUMES DRY PAVEMENT										
• A PROTECTIVE VEHICLE IS RECOMMENDED REGARDLESS IF A TMA IS AVAILABLE. IF NO TMA IS USED, THE PROTECTIVE VEHICLE SHALL BE STRATEGICALLY LOCATED IN THE FIELD TO SHIELD WORKERS AND NO ROLL AHEAD DISTANCE IS SPECIFIED.										

SIGN SPACING = X (feet)		
Freeways & Expressways	55/70 MPH	1500'+- (OR AS PER MUTCD)
Rural Highways	60/65 MPH	1000'+-
Rural Roads	45/55 MPH	500'+-
Rural Roads & Urban Arterials	35/40 MPH	350'+-
ALL SIGNS ARE 48" x 48" BLACK ON ORANGE UNLESS OTHERWISE DESIGNATED.		

All spacing may be adjusted to accommodate interchange ramps, at-grade intersections, and driveways.

MINIMUM TAPER LENGTH = L (feet)										
LANE WIDTH (feet)	Posted Speed (mph)									
	25	30	35	40	45	50	55	60	65	70
10	-	-	-	270	450	500	550	-	-	-
11	-	-	-	295	495	550	605	660	-	-
12	-	-	-	320	540	600	660	720	780	840

CHANNELIZING DEVICE SPACING (FEET)		
MPH	TAPER	TANGENT
50/70	40	80
40/45	30	60

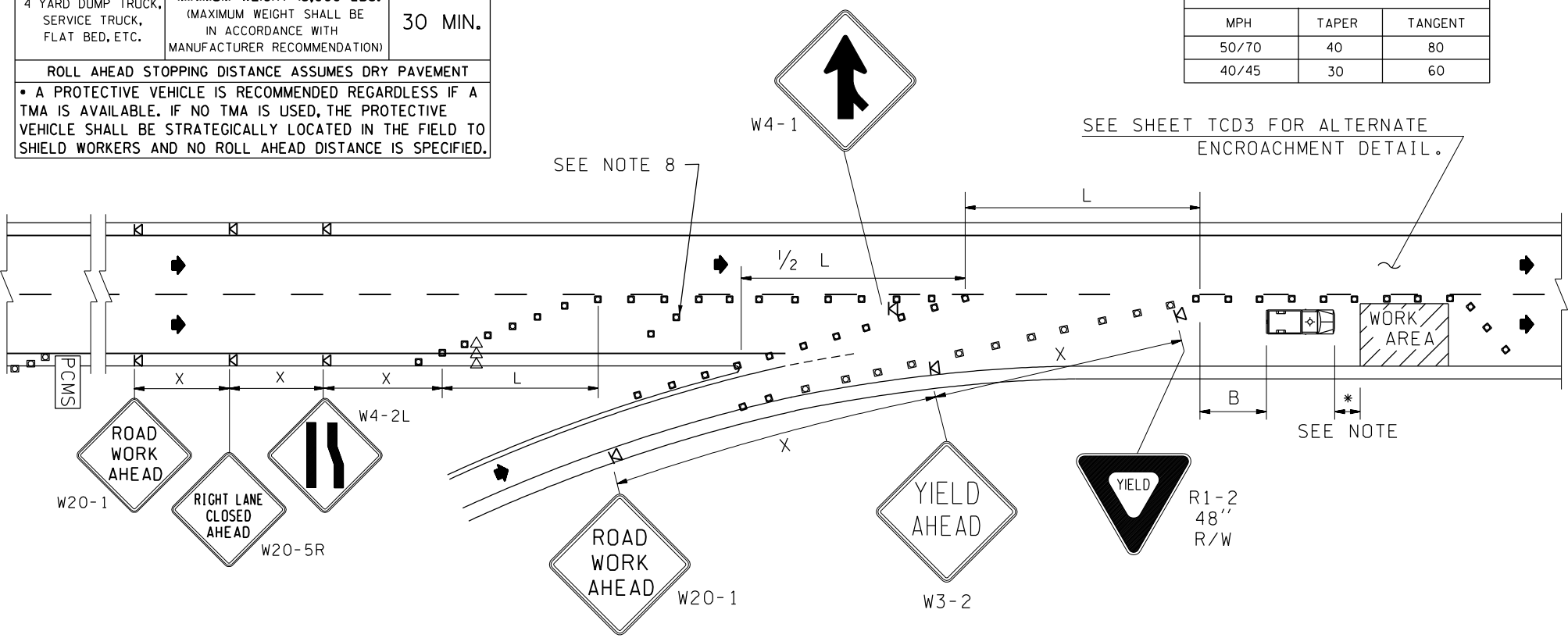

SEE SHEET TCD3 FOR ALTERNATE ENCROACHMENT DETAIL.

SEE NOTE 8

SEE NOTE

(SAMPLE MESSAGE)

PCMS	
1	2
LANE CLOSED	1 MILE AHEAD
1.5 SEC	1.5 SEC

Field locate 1 mile +- in advance of lane closure.

GENERAL NOTES

1. THE DESIRABLE RAMP WIDTH IS 14'.
2. A G20-2A END ROAD WORK SIGN SHOULD BE INSTALLED 500' BEYOND THE WORKAREA OR USE A DOWN STREAM TAPER.
3. CONTACT REGION TRAFFIC OFFICE FOR WORK HOUR RESTRICTIONS.
4. PROTECTIVE VEHICLE RECOMMENDED - MAY BE A WORK VEHICLE.
5. RECOMMEND EXTENDING DEVICE TAPER ACROSS SHOULDER. (L/3 TAPER)
6. PCMS RECOMMENDED.
7. TRAFFIC SAFETY DRUMS RECOMMENDED FOR ALL TAPERS ON HIGH SPEED ROADWAYS. (SEE DEVICE MATRIX)
8. USE TRANSVERSE DEVICES IN CLOSED LANE EVERY 1000'+-. (RECOMMENDED)
9. CONSIDER SHORT TERM CLOSURE OF RAMP.

LEGEND

- ⊠ SIGN LOCATION
- ▷▷ SEQUENTIAL ARROW SIGN
- □ □ CHANNELIZING DEVICES
- 🚚 PROTECTIVE VEHICLE - RECOMMENDED
- PCMS PORTABLE CHANGEABLE MESSAGE SIGN

TEMPORARY ON-RAMP FOR MULTI-LANE ROADWAYS
TCP 9

BUFFER DATA										
LONGITUDINAL BUFFER SPACE = B										
SPEED (MPH)	25	30	35	40	45	50	55	60	65	70
LENGTH (feet)	55	85	120	170	220	280	335	-	-	-
PROTECTIVE VEHICLE WITH TMA ROLL AHEAD DISTANCE										
TYPICAL PROTECTIVE VEHICLE TYPE WITH TMA	TYPICAL PROTECTIVE VEHICLE (WITH TMA) LOADED WEIGHT (LBS)						STATIONARY OPERATION (feet)			
4 YARD DUMP TRUCK, SERVICE TRUCK, FLAT BED, ETC.	MINIMUM WEIGHT 15,000 LBS. (MAXIMUM WEIGHT SHALL BE IN ACCORDANCE WITH MANUFACTURER RECOMMENDATION)						30 MIN			
ROLL AHEAD STOPPING DISTANCE ASSUMES DRY PAVEMENT										
• A PROTECTIVE VEHICLE IS RECOMMENDED REGARDLESS IF A TMA IS AVAILABLE. IF NO TMA IS USED, THE PROTECTIVE VEHICLE SHALL BE STRATEGICALLY LOCATED IN THE FIELD TO SHIELD WORKERS AND NO ROLL AHEAD DISTANCE IS SPECIFIED.										

SIGN SPACING = X (feet)		
Rural Roads	45/55 MPH	500'+-
Rural Roads & Urban Arterials	35/40 MPH	350'+-
Rural Roads, Urban Streets Residential & Business Districts	25/30 MPH	200'+-

ALL SIGNS ARE 48" x 48" BLACK ON ORANGE UNLESS OTHERWISE DESIGNATED.

All spacing may be adjusted to accommodate interchange ramps, at-grade intersections, and driveways.

LANE WIDTH (feet)	MINIMUM TAPER LENGTH = L (feet)									
	Posted Speed (mph)									
	25	30	35	40	45	50	55	60	65	70
10	105	150	205	270	450	500	550	-	-	-
11	115	165	225	295	495	550	605	-	-	-
12	125	180	245	320	540	600	660	-	-	-

CHANNELIZING DEVICE SPACING (FEET)		
MPH	TAPER	TANGENT
50	40	80
35/45	30	60
25/30	20	40

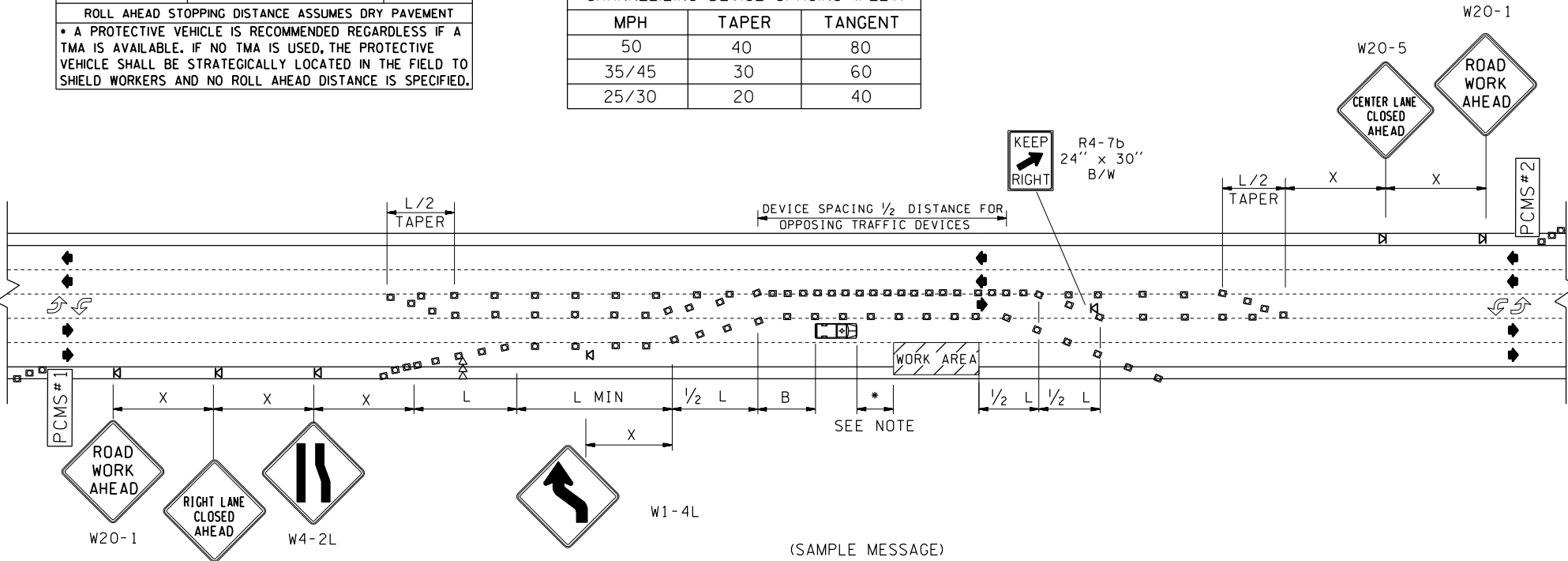

LEGEND

- ⊠ SIGN LOCATION
- ⊠⊠ SEQUENTIAL ARROW SIGN
- □ □ CHANNELIZING DEVICES
- 🚚 PROTECTIVE VEHICLE - RECOMMENDED
- PCMS PORTABLE CHANGEABLE MESSAGE SIGN

(SAMPLE MESSAGE)

PCMS #1	
1	2
RIGHT LANE CLOSED	NO LEFT TURNING
1.5 SEC	1.5 SEC

Field locate in advance of lane closure signing.

(SAMPLE MESSAGE)

PCMS #2	
1	2
CENTER LANE CLOSED	NO LEFT TURNING
1.5 SEC	1.5 SEC

Field locate in advance of lane closure signing.

GENERAL NOTES

1. PROTECTIVE VEHICLE RECOMMENDED - MAY BE A WORK VEHICLE.
2. RECOMMEND EXTENDING DEVICE TAPER ACROSS SHOULDER. (L/3 TAPER)
3. CONTACT REGION TRAFFIC OFFICE FOR WORK HOUR RESTRICTIONS.
4. IF THE LANE SHIFT IS SHORT AND HAS MINIMAL RADIUS CURVES (30 MPH OR LESS) USE SIGN W1-3 IN LIEU OF SIGN W1-4.
5. PCMS RECOMMENDED.

**RIGHT LANE CLOSURE WITH SHIFT
5 LANE ROADWAY
TCP 10**

BUFFER DATA										
LONGITUDINAL BUFFER SPACE = B										
SPEED (MPH)	25	30	35	40	45	50	55	60	65	70
LENGTH (feet)	55	85	120	170	220	280	-	-	-	-
PROTECTIVE VEHICLE WITH TMA ROLL AHEAD DISTANCE										
TYPICAL PROTECTIVE VEHICLE TYPE WITH TMA	TYPICAL PROTECTIVE VEHICLE (WITH TMA) LOADED WEIGHT (LBS)						STATIONARY OPERATION (feet)			
4 YARD DUMP TRUCK, SERVICE TRUCK, FLAT BED, ETC.	MINIMUM WEIGHT 15,000 LBS. (MAXIMUM WEIGHT SHALL BE IN ACCORDANCE WITH MANUFACTURER RECOMMENDATION)						30 MIN			
ROLL AHEAD STOPPING DISTANCE ASSUMES DRY PAVEMENT										
• A PROTECTIVE VEHICLE IS RECOMMENDED REGARDLESS IF A TMA IS AVAILABLE. IF NO TMA IS USED, THE PROTECTIVE VEHICLE SHALL BE STRATEGICALLY LOCATED IN THE FIELD TO SHIELD WORKERS AND NO ROLL AHEAD DISTANCE IS SPECIFIED.										

SIGN SPACING = X (feet)		
Rural Roads	45/55 MPH	500'+-
Rural Roads & Urban Arterials	35/40 MPH	350'+-
Rural Roads, Urban Streets Residential & Business Districts	25/30 MPH	200'+-
ALL SIGNS ARE 48" x 48" BLACK ON ORANGE UNLESS OTHERWISE DESIGNATED.		

MINIMUM TAPER LENGTH = L (feet)										
LANE WIDTH (feet)	Posted Speed (mph)									
	25	30	35	40	45	50	55	60	65	70
10	105	150	205	270	450	500	-	-	-	-
11	115	165	225	295	495	550	-	-	-	-
12	125	180	245	320	540	600	-	-	-	-

CHANNELIZING DEVICE SPACING (FEET)		
MPH	TAPER	TANGENT
50	40	80
35/45	30	60
25/30	20	40

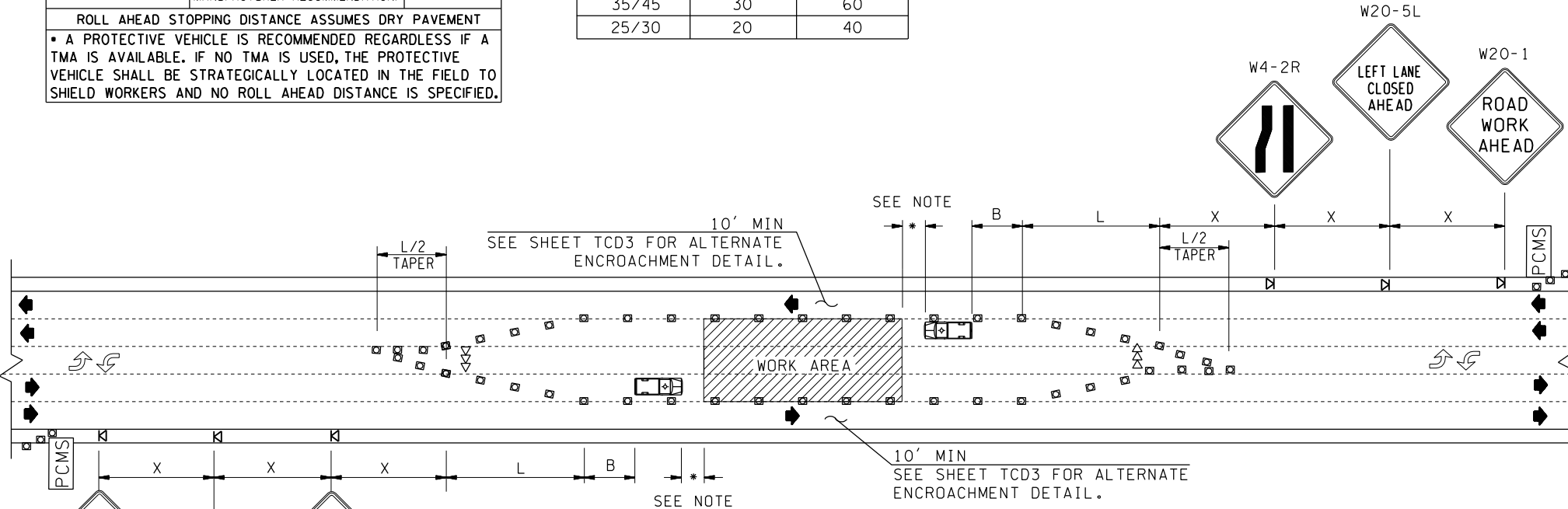

(SAMPLE MESSAGE)

PCMS	
1	2
CENTER LANE CLOSED	NO LEFT TURNING
1.5 SEC	1.5 SEC

Field locate in advance of lane closure signing.

GENERAL NOTES

1. PROTECTIVE VEHICLE RECOMMENDED - MAY BE A WORK VEHICLE.
2. CONTACT REGION TRAFFIC OFFICE FOR WORK HOUR RESTRICTIONS.
3. PCMS RECOMMENDED.

LEFT LANE AND CENTER TURN LANE CLOSURE - 5 LANE ROADWAY
TCP 11

LEGEND

- ⊠ SIGN LOCATION
- ⇒⇒ SEQUENTIAL ARROW SIGN
- □ □ CHANNELIZING DEVICES
- 🚚 PROTECTIVE VEHICLE - RECOMMENDED
- PCMS PORTABLE CHANGEABLE MESSAGE SIGN

BUFFER DATA										
LONGITUDINAL BUFFER SPACE = B										
SPEED (MPH)	25	30	35	40	45	50	55	60	65	70
LENGTH (feet)	55	85	120	170	220	280	335	415	-	-
PROTECTIVE VEHICLE WITH TMA ROLL AHEAD DISTANCE										
TYPICAL PROTECTIVE VEHICLE TYPE WITH TMA	TYPICAL PROTECTIVE VEHICLE (WITH TMA) LOADED WEIGHT (LBS)							STATIONARY OPERATION (feet)		
4 YARD DUMP TRUCK, SERVICE TRUCK, FLAT BED, ETC.	MINIMUM WEIGHT 15,000 LBS. (MAXIMUM WEIGHT SHALL BE IN ACCORDANCE WITH MANUFACTURER RECOMMENDATION)							30 MIN		
ROLL AHEAD STOPPING DISTANCE ASSUMES DRY PAVEMENT										
<ul style="list-style-type: none"> A PROTECTIVE VEHICLE IS RECOMMENDED REGARDLESS IF A TMA IS AVAILABLE. IF NO TMA IS USED, THE PROTECTIVE VEHICLE SHALL BE STRATEGICALLY LOCATED IN THE FIELD TO SHIELD WORKERS AND NO ROLL AHEAD DISTANCE IS SPECIFIED. 										

MINIMUM TAPER LENGTH = L (FEET)										
LANE WIDTH (feet)	Posted Speed (mph)									
	25	30	35	40	45	50	55	60	65	70
10	105	150	205	270	450	500	550	-	-	-
11	115	165	225	295	495	550	605	660	-	-
12	125	180	245	320	540	600	660	720	-	-

SIGN SPACING = X (feet)		
Rural Highways	60/65 MPH	1000'+-
Rural Roads	45/55 MPH	500'+-
Rural Roads & Urban Arterials	35/40 MPH	350'+-
Rural Roads, Urban Streets Residential & Business Districts	25/30 MPH	200'+-
ALL SIGNS ARE 48" x 48" BLACK ON ORANGE UNLESS OTHERWISE DESIGNATED.		

All spacing may be adjusted to accommodate interchange ramps, at-grade intersections, and driveways.

CHANNELIZING DEVICE SPACING (FEET)		
MPH	TAPER	TANGENT
50/60	40	80
35/45	30	60
25/30	20	40

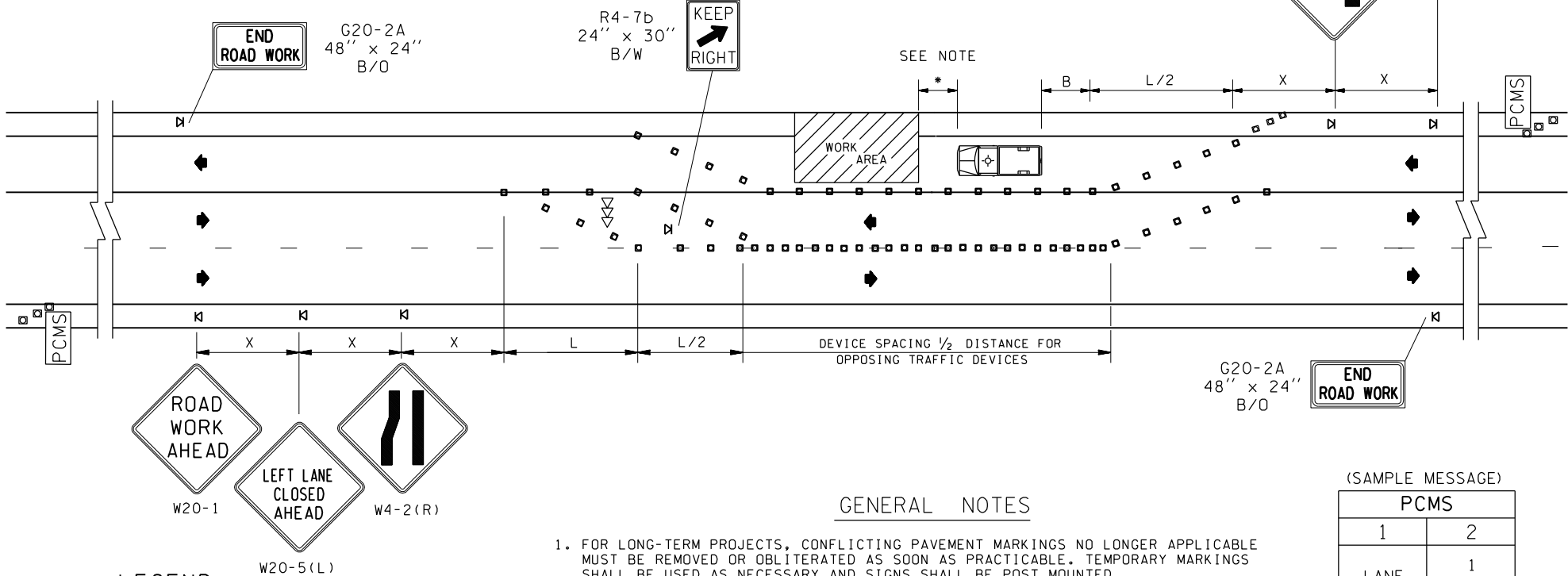

LEGEND

- ⊠ SIGN LOCATION
- ⇒⇒ SEQUENTIAL ARROW SIGN
- □ □ CHANNELIZING DEVICES
- 🚚 PROTECTIVE VEHICLE - RECOMMENDED
- PCMS PORTABLE CHANGEABLE MESSAGE SIGN

GENERAL NOTES

1. FOR LONG-TERM PROJECTS, CONFLICTING PAVEMENT MARKINGS NO LONGER APPLICABLE MUST BE REMOVED OR OBLITERATED AS SOON AS PRACTICABLE. TEMPORARY MARKINGS SHALL BE USED AS NECESSARY AND SIGNS SHALL BE POST MOUNTED.
2. STEADY BURN WARNING LIGHTS (TYPE C, MUTCD) SHOULD BE USED ON CHANNELIZING DEVICES AT NIGHT FOR DELINEATION.
3. FOR SPEED LIMITS OF 30 MPH OR LESS, USE SIGN W1-3 IN LIEU OF SIGN W1-4.
4. RECOMMEND EXTENDING CHANNELIZATION DEVICE TAPER ACROSS SHOULDER. (L/3 TAPER)
5. PCMS RECOMMENDED.

(SAMPLE MESSAGE)

PCMS	
1	2
LANE CLOSED	1 MILE AHEAD
1.5 SEC	1.5 SEC

Field locate 1 mile +- in advance of lane closure.

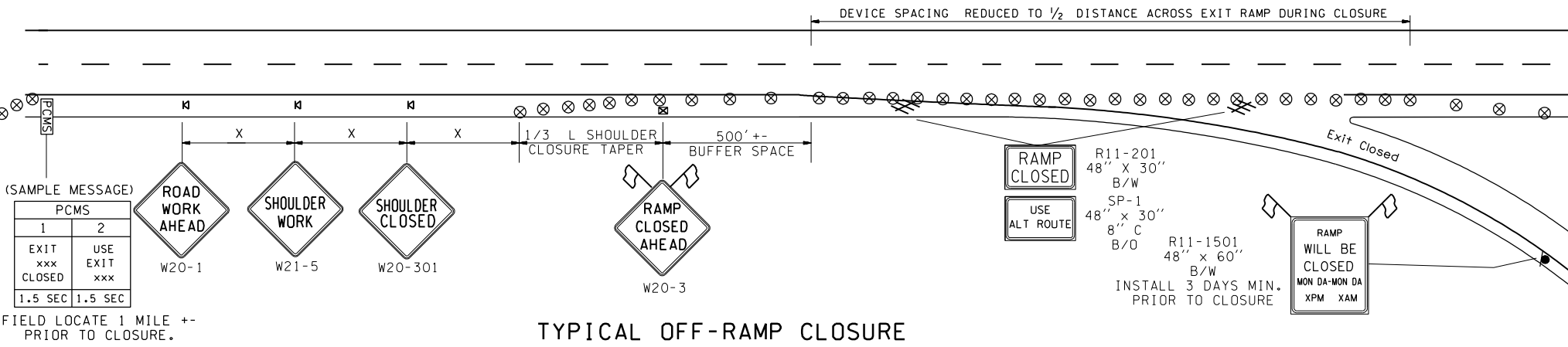

TYPICAL OFF-RAMP CLOSURE

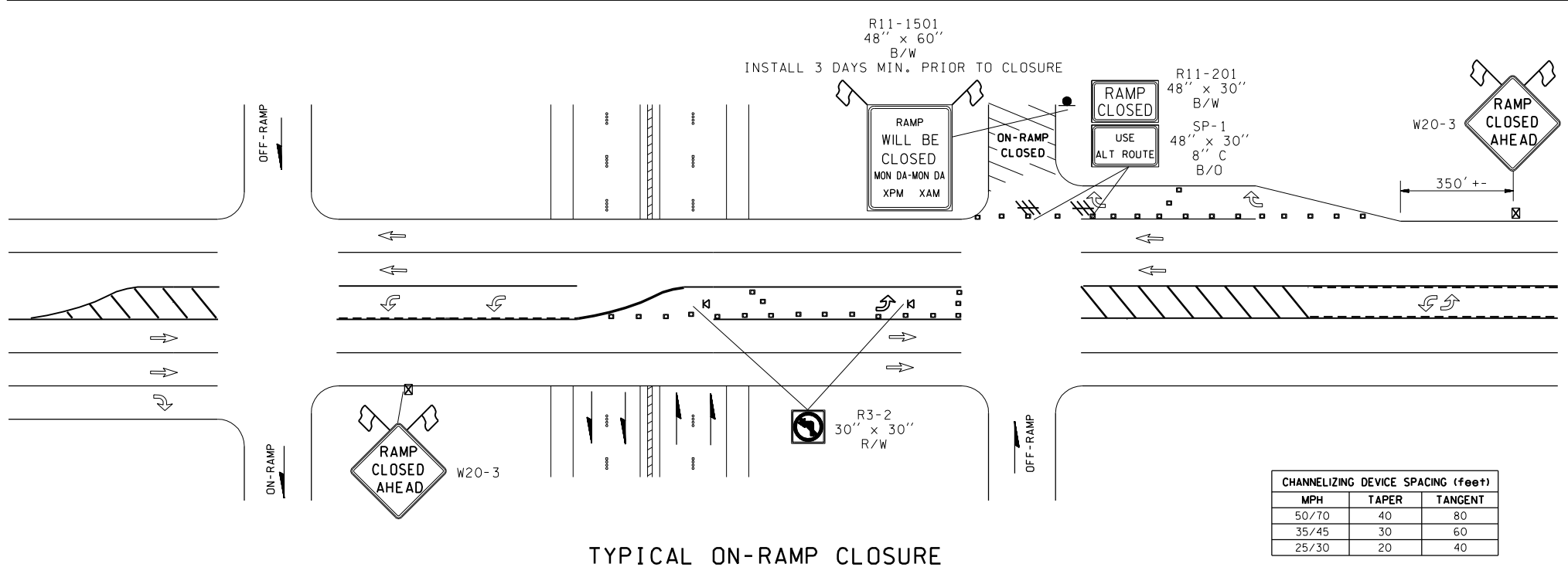

TYPICAL ON-RAMP CLOSURE

GENERAL NOTES

- CONTACT REGION TRAFFIC OFFICE FOR WORK HOUR RESTRICTIONS
- TYPICAL APPLICATION SHOWN, ADJUST FOR SITE CONDITIONS.

LEGEND

- PORTABLE CHANGEABLE MESSAGE SIGN (RECOMMENDED)
- TRAFFIC SAFETY DRUM
- SIGN LOCATION - TRIPOD MOUNT
- SIGN LOCATION - POST MOUNT
- CHANNELIZING DEVICE
- WARNING FLAG - FLUORESCENT RED/ORANGE
- SIGN LOCATION - PORTABLE MOUNT - (7 FT MOUNTING HEIGHT)
- TYPE III BARRICADE

LANE WIDTH (feet)	MINIMUM TAPER LENGTH = L (feet)									
	Posted Speed (mph)									
	25	30	35	40	45	50	55	60	65	70
10	105	150	205	270	450	500	550	-	-	-
11	115	165	225	295	495	550	605	660	-	-
12	125	180	245	320	540	600	660	720	780	840

SIGN SPACING = X (feet)		
Freeways & Expressways	55/70 MPH	1500'+- (OR AS PER MUTCD)
Rural Highways	60/65 MPH	1000'+-
Rural Roads	45/55 MPH	500'+-
Rural Roads & Urban Arterials	35/40 MPH	350'+-
Rural Roads, Urban Streets Residential & Business Districts	25/30 MPH	200'+-
ALL SIGNS ARE 48" x 48" BLACK ON ORANGE UNLESS OTHERWISE DESIGNATED.		

All spacing may be adjusted to accommodate interchange ramps, at-grade intersections, and driveways.

SHORT DURATION WORK ZONES

Traffic Control Plans (TCP's) 14 to 20

Introduction

Short duration work zones are work activities up to 60 minutes. Due to the short work time, simplified traffic control set-ups are allowed to reduce the hazards of traffic exposure to workers. The time it may take to set up a full complement of signs and devices could approach or exceed the amount of time it requires to perform the work.

Short duration work zones provide a safety benefit for both drivers and workers since the time duration is less than implementation of stationary work zones thereby reducing exposure time to traffic and work hazards. Motorists also receive a mobility benefit from reduced traffic impacts and associated rear-ending congestion crashes. These safety and mobility benefits are consistent with the department's responsibility and policy to protect both drivers and workers while maintaining an acceptable level of mobility.

Careful consideration of traffic and roadway conditions must be given to each work zone prior to selecting the most appropriate traffic control set-up. Shoulder work and low-speed, low-volume traffic conditions may only require the use of the work vehicle hazard beacon and personal protective equipment. High-speed, high-volume lane work may require a full lane closure set-up, even though the work duration may be 60 minutes or less. Remember, short duration work is not a "short-cut", it's a traffic control method that reduces worker exposure to traffic hazards by using larger, more dominant and mobile equipment instead of many smaller devices (cones may still be recommended since they are quick to set up for small work zones).

Examples of short duration work zone operations include, re-lamping, pot hole repair, surveying, minor repairs, bridge inspection, field recon, pre-work layout, etc.

Guidance

The following guidance applies standards from the MUTCD to provide more specific direction to those involved in short duration work zones. The following provides decision making rationale to assist with selection of appropriate short duration traffic control and safety measures. Because of the complex and dynamic nature of all the elements involved in work zones the intent of this chapter is to assist supervisors and workers in decision making by resolving some of the confusion and subjectivity previously associated with short duration work zones. The included specific guidance and direction, rules, consideration chart and example TCP's should lead to an informed choice. Remember, there is no single solution that fits all work zones. Reliance on work zone training, including a working knowledge of this section combined with sound judgment of the site conditions is the foundation for safe and effective short duration work zones.

- Consider stationary work zone measures with a full compliment of signs and devices first. Some work operations, traditionally classified as short duration, may be able to be conducted as longer term stationary work by linking several work areas together

under a lane or shoulder closure. Advantages of linking work operations may include reducing exposure of workers to traffic, efficiencies in completing tasks concurrently, reducing the number of lane closures in the same area, and overall reduction in impacts to traffic.

- Consider mobile operations. Other short duration operations may be able to be conducted as mobile operations by progressing through several short duration work areas by making intermittent stops. Advantages are shortened work operations to install traffic control devices and improved worker safety through use of mobile equipment (TMA's, PCMS, mobile work vehicles, etc.) to reduce worker exposure to traffic hazards.
- Consider alternative work operations, materials and equipment, such as:
 - Work crews may be combined to accomplish work more effectively under mobile or stationary work zones, weekend or night closures, and other identified work locations or operations that may be difficult to accomplish with a small crew.
 - Identify “red zones” where short duration work zones are not a desirable choice due to poor traffic conditions (high volume, high speed, weaving areas, bridges, interchanges, etc.).
 - A specialized work zone traffic control crew could be considered for use to support work crew operations. The specialized team can provide a higher level of efficiency and safety for a work crew focused only on the work. This can also reduce the overall time duration, thereby reducing worker exposure to traffic hazards.
- Consider resources needed for unplanned short duration work (non-emergency)

These operations may be referred to as “call outs”, not necessarily an emergency but a short notice response to a report of debris, repairs, or other situation where the exact nature of the work or location may not be completely known.

An on-site assessment may allow work to proceed with available equipment and devices. Strategic placement of the work vehicle with warning beacon is important. Devices and signs may also be needed. If work is expected to last more than 60 minutes additional resources may be needed to implement a traditional stationary work zone. Work may have to be delayed until the proper work zone equipment and devices are available. Assistance from region WSDOT Incidence Response may also be appropriate.

- Key elements of short duration work zones
 - Work Location – This element may be the most obvious but it is also the most important, at least initially, since it establishes the relationship to the next three elements. The location directly influences the assessment of hazards, protection

and warning. General roadway locations such as shoulders, lanes, medians, etc. are common but unique locations with narrow shoulders, bridges, undefined shoulders (no edge stripe), poor sight distance, tight radius curves, etc. require even more consideration.

- o Hazards – This element is essential to determine and address safety hazards to workers and drivers. Traffic volume and speed is the primary hazard concern for workers in short duration work zones, while unexpected workers or equipment are the primary hazard for drivers. Assessment of all potential hazards at the work site is important to minimize the occurrence of an unexpected hazardous situation. Contingency plans and an escape route should be part of this assessment.
- o Protection – This element establishes an appropriate level of worker protection based on assessment of the hazards involved. Positive worker protection is always recommended when practical but not necessarily required for less hazardous work zones. The use of a protective vehicle (work vehicle) can offer valuable worker protection in any work zone condition.
- o Warning – This element provides for establishing the appropriate level of warning for drivers approaching and driving through the work zone. Advance warning to drivers is required when working within 15’ of the edge of the roadway. In many short duration work zone locations the work vehicle warning beacon, assuming there is adequate sight distance, can provide this. Sign(s) may be needed for areas with reduced sight distance.
- o Duration – This element is equally important as work location since it has a direct relationship to worker exposure to hazards. Duration also has the most influence over the other key elements. As mentioned in previous guidance, short duration work zones can offer safety and mobility benefits, but not at the risk of too much worker exposure to hazards.

- **Short Duration Work Zone Condition**

Short duration work zones are categorized into three relative condition types. This helps to establish a practical application level of traffic control and safety devices based on hazard, protection and warning levels related to work location and time duration. The MUTCD allows for simplified traffic control procedures for short duration work, but does not go into any detail on what those simplified procedures might be. Establishing a work zone condition level helps to answer the question; “Which traffic control and safety devices are appropriate for use as part of the allowed simplified procedures?”

The condition levels are:

- o A - represents the lowest level of work zone impacts and is typified by:
 - Low traffic speed and volume.

- Time durations are short or very short, approximately 0 to 20 minutes. Work locations not within a traveled lane, such as shoulders, may be allowed up to 60 minutes.
 - A wide variety of work locations may be encountered at this level.
 - Minimum levels of warning, protection and hazards. A work vehicle with warning beacon and personal protective equipment may be adequate. See TCP's.
- B- represents moderate work zone impacts and is typified by:
 - Low or high traffic speed with low to moderate volumes.
 - Moderate time durations, approximately 0 to 40 minutes. Work locations not within a traveled lane, such as medians, may be allowed up to 60 minutes.
 - A wide variety of work locations may be encountered at this level that may include median, gore, lanes and intersections.
 - Moderated levels of warning and protection, such as a spotter, cones or PCMS added to condition "A" devices would be typical considerations. Refer to TCP's.
 - C - represents the highest impact level and is typified by:
 - High traffic speed and volume.
 - Maximum time duration, up to 60 minutes.
 - A wide variety of work locations may be encountered at this level, but all should be considered as presenting a significant hazard level even if time durations are short.
 - All applicable traffic control and safety devices should be considered, such as PCMS, TMA's and signs. See TCP's.

While some of the elements within a particular work zone may not all exist within one condition, the relative types of elements that either identify the condition or are representative of those measures and values that could be applied to a work zone of that general condition level are shown. This is an important consideration for use, since it helps to clarify which types of devices could be applied to a work zone within practical time duration.

The short duration work zone condition level does not necessarily provide for a complete or final assessment, but it is a valuable tool for finding the best balance between time duration and the other work zone key elements. Time duration is an important consideration for short duration work zones; worker safety risk consideration cannot be ignored no matter how short the work time duration is. A common example of this condition is high-speed and high-volume traffic (urban freeway) with an in lane work location. Even though the work duration may be very short, work hazards as identified in condition "C" may need to be considered for mobile or stationary lane closures because the safety risk to workers and road users could be too great. Conversely, work zones typified by condition "A" may be allowed for longer (60 minutes maximum) duration since the safety risk to workers and road users is low.

- **Work Zone Traffic Control Plans (TCP)**

The example TCP's in this section are representative of several types of short duration work zones. The TCP's show the types of devices and equipment that can be applied for various work zone conditions. Work crews should review these TCP's for application and use in establishing their work zones. Additional TCP's should be developed to address work operations not covered by these TCP's.

No distinction is made as to the type of work operation for these TCP's. These TCP's are typical by nature and are adaptable to most work operations such as surveying, maintenance work, utility work and some minor construction operations. Unique work crews and operations may need more specific TCP's. The Region Traffic Offices can assist with TCP development.

- **Short duration work zone rules**

- 1. When working in a live lane or intersection workers must be adequately protected and/or warned as appropriate for the work zone condition.**

- Positive protection – TMA's, Buffer Vehicle, Barriers – (typically condition "C").
- Lane closure – Channelizing devices, PCMS, etc. – (typically condition "B")
- Spotter – Audible warning device or verbal as needed. – (typically condition "A" or "B" when working between adequately safe gaps in traffic. Sufficient warning allows worker to safely return to shoulder)
- Escape routes/plans must be considered prior to starting work.

- 2. Drivers must be adequately warned as they approach the work zone – (see sight distance chart on TCP 27) Consider the following types of warning:**

- Flashing warning beacon on work vehicle
- Warning signs
- PCMS, Arrow Board (caution mode), Flag Tree or other approved dominant device.
- TCP's and work zone condition dictate the specific level of warning required.

- 3. Several intermittent work operations within a one-mile area lasting for more than 60 minutes should be considered for a mobile or stationary work zone and are not typically acceptable for short duration work zone operations. An assessment of the most effective and safe operation should be made.**

- 4. Live traffic areas (lanes & intersections) in high speed and high volume work locations may not be good candidates for short duration work zones since the conditions are not desirable for driver warning or worker protection. Work zone condition "C" would apply to most of these type of locations and may be acceptable**

based on a positive site assessment and working only on the shoulder or adjacent lane as follows:

- **No unprotected work in interior lanes of multi-lane, (3 or more lanes) roads and no “island” work areas are allowed.**
 - **Lanes of multi-lane roads may only be accessed from the adjacent shoulder.** (see TCP 19)
 - **Intersections may be accessed following the same manner as above and consideration should be given to incorporating the existing intersection control into the work zone traffic control.....all red signal control or all way stop control may supplement the selected traffic control measures.** (see TCP’s 28 & 29).
- 5. Short duration flagging operations are not allowed.** All flagging requirements must be complied with and there currently is no exception for short duration work. Emergencies are the only exception to full flagging requirements. Flagging is defined by the MUTCD as stopping, directing or alerting road users. For the purposes of this section a spotter or worker may, and should be prepared to, warn or stop drivers of errant or unexpected vehicles, but not as a routine form of traffic control.
- 6. A determination of a safe work location as it relates to acceptable worker exposure to potential traffic hazards must be made.** A basic determination can be made by observing traffic conditions (speed, volume, location, visibility, etc.) and assessing the following conditions:
- Is the work location out of the traffic path? (shoulder, median, sidewalk, etc.)
 - Is there sufficient time for a worker to safely walk (not run) to and return from the work location? (across lanes to shoulder, into lane and back, etc., typically condition “A”)
 - Are there other hazards (traffic or non-traffic) at the location that could affect worker safety?
 - Is there an effective contingency or escape plan?
 - Is there adequate sight distance from the work location to approaching traffic? (see chart TCP 27)

Understanding the intent and application of this section should provide valuable guidance while at the same time provide for the flexibility needed to respond to a wide variety of work operations. As with any work zone, worker safety and driver safety should be the first priority when planning for and conducting work operations. This is of even greater concern for short duration work zones since workers may be without the benefit of positive protection and extensive driver warning. Motorists may tend to encounter short duration work zones unexpectedly with a minimum of guidance and protection. Supervisors should be confident that the guidance of this section is understood and applied by their work crews, that worker and driver safety is acceptable or improved through the use of short duration work zones and that the balance between safety and work duration is appropriate.

Very Short Duration Work Zones

The overall guidance of the short duration work zone section of this guidebook applies to work zones that may last up to 60 minutes. However, it is important to recognize that many work actions or portions of work operations may take only a few seconds or minutes to perform.

These types of actions might be:

- Debris retrieval; locating drainage structures or other roadway features or components
- Retrieval of lost cargo; work zone sign or device installation and removal
- Crash debris retrieval; a survey “shot”, monument or other reference check
- Crossing or walking along the roadway, motorist assistance

In many cases it is necessary and allowable for workers to walk on a roadway shoulder, cross traffic lanes or momentarily step into a lane to access work locations or to perform work. These actions can only be accomplished if they are not in conflict with traffic or other hazards and it is safe to do so. See the applicable rules of this section for worker safety and protection.

Very short duration work is typified by the following:

- The primary intent is not to conduct an actual work operation in total, but more related to gathering information, accessing a location, or a non-repetitive action as described above.
- Generally these actions occur at isolated locations or the locations are spaced far enough apart that they would constitute separate work zones.
- Equipment is usually not required, other than the possibility of simple hand tools.

Because of the very short duration and nature of these actions, there is a possibility that adequate work zone measures may not be fully considered by those involved or by supervisors. Even though these are very short duration actions, the key work zone elements must still be considered. High worker exposure locations, such as in a live lane and undesirable traffic conditions, such as high volumes, would still dictate the decision on implementing the appropriate work zone. It may be acceptable to perform some very short duration actions under work zone condition “A” & “B”, with the minimum required equipment and devices. In most cases this would be a strategically placed work vehicle with warning beacon and personal protective equipment. It is recommended to apply more work zone safety measures if the level of safety can be raised without adding to worker exposure time. Working in teams of two, where one worker can act as a spotter from a safe location, may be a good example of an additional safety measure. The workers ability to maintain awareness of traffic conditions and potential hazards is a key concern.

Normally, specific TCP’s are not required for these very short actions since the typical example TCP’s for very short duration work zones can cover a wide variety of applications.

Short Duration Work Zone Considerations Chart

This chart provides for a logical process to evaluate short duration work zones based on the five key elements described earlier and several related issues for each element. Consideration of these elements in a step-by-step process will help to ensure that an adequate assessment is made leading to selection of the appropriate traffic control and safety measures incorporated into the Traffic Control Plan (TCP). The chart alone does not provide for a complete or final decision on the level of traffic control and safety measures needed, but is a valuable tool for conducting the assessment and identifying issues that need to be addressed.

Step 1

Consider the work zone location

- Lane – traffic hazard, see TCP's for work zone details
- Intersection – traffic hazard, see TCP's for work zone details
- Median – potential traffic hazards on both sides
- Shoulder – consider narrow shoulders and potential for errant vehicles
- Off Roadway – traffic control is not required for work areas 15' or more off the roadway edge, but protection should be considered.

Step 2

Consider hazards to workers and road users

- Traffic – volume, speed, configuration, driver confusion
- Equipment – clearance to traffic, operator access
- Fall/Trip – clear worker path, barriers, obstacles
- Debris – crash, cargo, etc. (remove manually or equipment)
- Other – as determined at the site

Step 3

Consider worker protection measures

- Positive Protection – TMA, buffer/shadow vehicle (may be a work vehicle), barriers
- Devices – cones, drums, etc., may alert drivers and delineates work and traffic separation
- Spotter – effective to warn workers (requires safe location for spotter)
- Escape Route or Refuge – as part of a contingency plan for unexpected events

Step 4

Consider road user warning measures (may include guidance and protection as needed)

- Dominant Warning Devices – PCMS, Arrow board, flag tree
- Signs – advance warning message or specific to work operation

- Channelizing & Warning Devices – cones, drums, type A or B lights
- Vehicle Warning Beacon – requires adequate sight distance
- Protective Equipment – TMA, buffer/shadow vehicle (may be a work vehicle), personal protective equipment

Step 5

Consider time duration of work (directly related to worker & road user exposure to hazards)

- Low – 0 to 20 minutes
- Moderate – 0 to 40 minutes
- High – 0 to 60 minutes, consider stationary or mobile traffic control

High traffic volume and high-speed work locations require careful consideration of traffic control devices as shown on the typical TCP's regardless of how short the time duration may be.

Step 6

Consider which Short Duration TCP is appropriate for the work operation based on the previous 5 consideration steps and any other considerations that may be applicable. Also, consider the need to develop a new TCP if the example TCP's do not fit the work operation. Contact the Region Traffic Office for assistance.

SHORT DURATION WORK ZONES

DO'S and DON'TS

Don't –

- Take “short cuts” or hurry to accomplish work. Determination of all work zone hazards is a must.
- Run across or “dodge” traffic in live lanes.
- Work in a live lane under adverse traffic conditions or without proper traffic control in place.....even if it's only for a minute or few seconds.
- Assume that shoulder areas are automatically safe because you are not in a live traffic lane. Distracted, aggressive or impaired drivers may encroach into shoulder areas. Also, oversized loads may present a hazard.
- Turn your back to oncoming traffic if possible. Awareness of traffic is an important self-protection element.
- Put yourself in an unexpected location that may surprise a driver.

Do –

- Use the work vehicle as protection and warning whenever possible.
- Take advantage of any resources that provide protection and warning without causing additional worker exposure. (TMA's, buffer/shadow vehicles, PCMS, etc.)
- Plan ahead. Poor planning is not a valid excuse for lack of equipment, devices or awareness of traffic conditions.
- Whenever possible, find the safest available location to park or unload equipment.
- Avoid high traffic volume hours and locations. Plan ahead for better traffic conditions or consider alternate work operations.
- Work on the same side of the road as the work vehicle and warning beacon whenever possible.

WORK ZONE CONDITION (SEE CONDITION GUIDANCE)

- A - ALLOWED, VEHICLE #1 REQUIRED, ALL OTHER DEVICES OPTIONAL.
- B - ALLOWED, VEHICLE #1 REQUIRED, CONSIDER USE OF SPOTTER, DEVICES, VEHICLE #2 AND LOW VOLUME WORK HOURS.
- C - NOT ALLOWED, CONSIDER MOBILE OR STATIONARY TCP'S.

NOTES:

1. STOPPING TRAFFIC FOR UP TO 20 MINUTES MAY ALSO BE ALLOWED. (CONTACT & COORDINATE WITH REGION TRAFFIC OFFICE)
2. RESTRICTED SIGHT DISTANCE REQUIRES ADDITIONAL ADVANCE WARNING DEVICES OR SIGNS, SEE TCP 27 FOR SIGHT DISTANCE CHART.
3. REFER TO PAGE 17 FOR ROLL AHEAD AND BUFFER DATA INFORMATION.

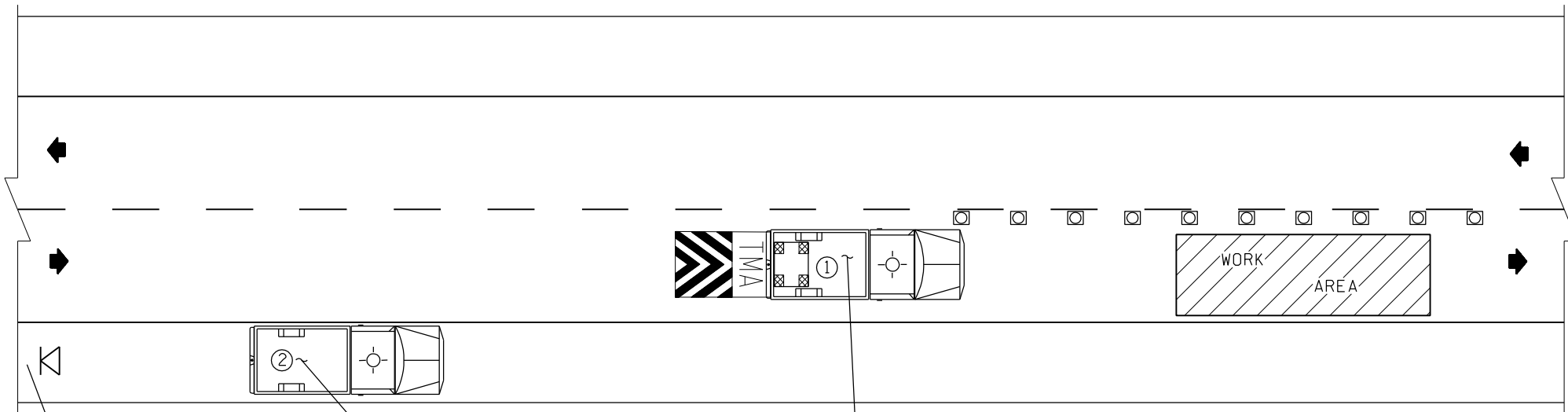

LEGEND

- WARNING BEACON - REQUIRED
- SIGN LOCATION - TRIPOD MOUNT
- CHANNELIZING DEVICE
- TRUCK MOUNTED ATTENUATOR (RECOMMENDED) (PCMS OPTIONAL)
- PROTECTIVE VEHICLE - REQUIRED
- PROTECTIVE VEHICLE
- SEQUENTIAL ARROW SIGN - CAUTION MODE (RECOMMENDED)



W20-1
48'' x 48''
B/O

OPTIONAL
SEE NOTE #2



W20-7B
48'' x 48''
B/O

OR
USE PCMS

R4-2
24'' x 30''
B/W



OR
USE PCMS

TYPICAL SHORT DURATION LANE CLOSURE
2 LANE OPERATION
TCP 14

WORK ZONE CONDITION (SEE CONDITION GUIDANCE)

- A - ALLOWED, VEHICLE #1 REQUIRED, ALL OTHER DEVICES OPTIONAL.
- B - ALLOWED, VEHICLE #1 REQUIRED, CONSIDER USE OF SPOTTER, DEVICES.
- C - NOT ALLOWED, CONSIDER MOBILE OR STATIONARY TCP'S.

NOTES:

1. VEHICLE #3 MAY BE NEEDED BASED ON TRAFFIC VOLUMES.
2. RESTRICTED SIGHT DISTANCE REQUIRES ADDITIONAL ADVANCE WARNING DEVICES OR SIGNS, SEE TCP 27 FOR SIGHT DISTANCE CHART.
3. REFER TO PAGE 17 FOR ROLL AHEAD AND BUFFER DATA INFORMATION.

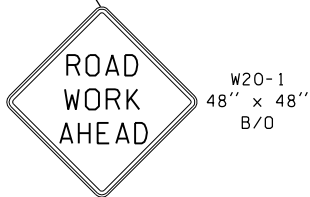
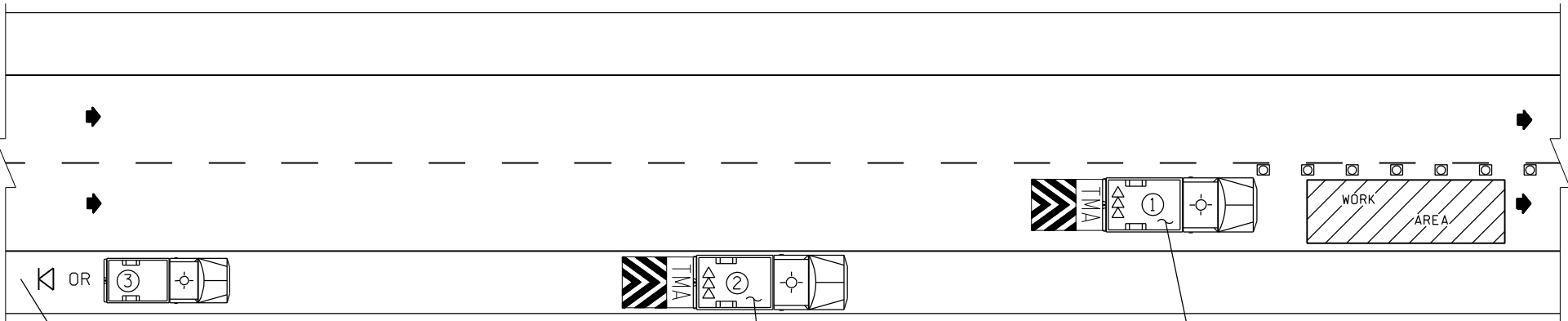

OPTIONAL
SEE NOTE #2

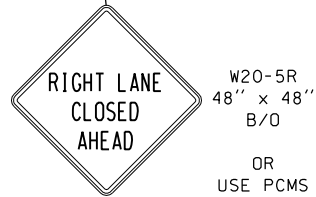

W20-5R
48" x 48"
B/O
OR
USE PCMS

PCMS	
1	2
LANE CLOSED	MERGE LEFT
1.5 SEC	1.5 SEC

TRUCK MOUNTED PCMS

LEGEND

- WARNING BEACON - REQUIRED
- SIGN LOCATION - TRIPOD MOUNT
- CHANNELIZING DEVICE
- TRUCK MOUNTED ATTENUATOR (RECOMMENDED) (PCMS OPTIONAL)
- PROTECTIVE VEHICLE - REQUIRED
- PROTECTIVE VEHICLE
- PROTECTIVE VEHICLE
- SEQUENTIAL ARROW SIGN - REQUIRED

TYPICAL SHORT DURATION LANE CLOSURE
MULTI-LANE OPERATION
TCP 15

WORK ZONE CONDITION (SEE CONDITION GUIDANCE)

- A - ALLOWED - CONSIDER USING A SPOTTER
- B - ALLOWED - SPOTTER AND/OR CHANNELIZING DEVICES RECOMMENDED, CONSIDER TMA AND/OR PCMS/ARROW CAUTION MODE.
- C - ALLOWED - SPOTTER, CHANNELIZATION DEVICES AND PCMS/ARROW RECOMMENDED, CONSIDER TMA.

NOTES:

1. RESTRICTED SIGHT DISTANCE REQUIRES ADDITIONAL ADVANCE WARNING DEVICES OR SIGNS, SEE TCP 27 FOR SIGHT DISTANCE CHART.
2. NARROW SHOULDERS THAT DO NOT PROVIDE FOR WORK OPERATIONS WITHOUT LANE ENCROACHMENT - 10' LANE MINIMUM, REQUIRES LANE CLOSURE, SEE TCP 14 OR 15.
3. REFER TO PAGE 17 FOR ROLL AHEAD AND BUFFER DATA INFORMATION.

** ROADWAY EXAMPLE REPRESENTS TYPICAL LOCATION.
 OPTIONAL LOCATION MAY BE - LEFT OR RIGHT SHOULDERS, MEDIAN OR GORE AREA

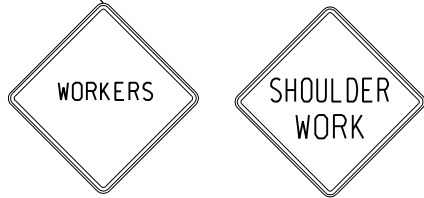
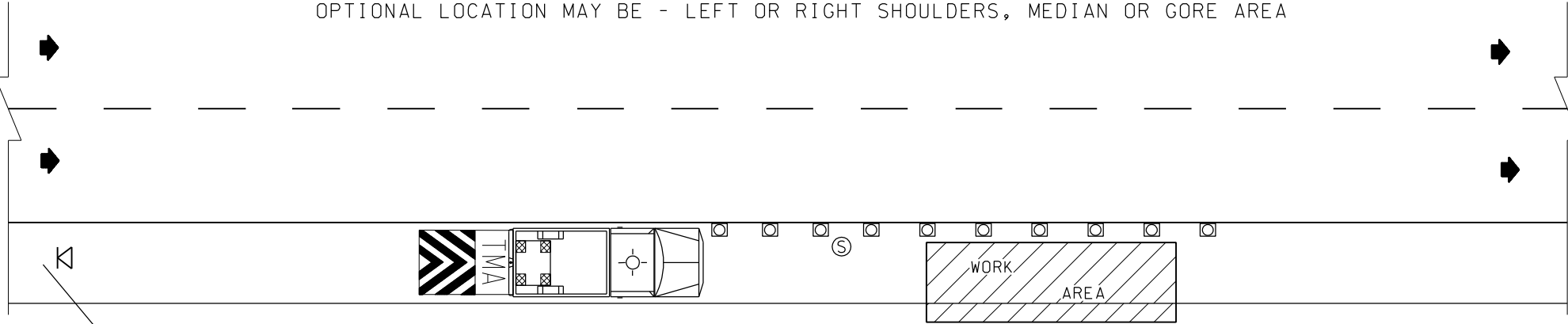

W21-1
 48" x 48" B/O
 OR
 W21-5
 48" x 48" B/O
 OR OTHER APPROPRIATE
 ADVANCE WARNING SIGN
 OR PCMS
 (OPTIONAL SEE NOTE 1)

LEGEND

- WORK VEHICLE W/ WARNING BEACON
- SIGN LOCATION - (SEE NOTE 1)
- CHANNELIZING DEVICE
- SPOTTER
- SEQUENTIAL ARROW PANEL - TYPE "B"
(CAUTION MODE)
- TRUCK MOUNTED ATTENUATOR
(RECOMMENDED)

TYPICAL SHORT DURATION SHOULDER WORK
 TCP 16

WORK ZONE CONDITION (SEE CONDITION GUIDANCE)

- A - ALLOWED - CONSIDER USING A SPOTTER, WORK VEHICLE REQUIRED.
- B - ALLOWED - SPOTTER AND/OR CHANNELIZING DEVICES RECOMMENDED, CONSIDER TMA AND/OR PCMS/ARROW CAUTION MODE.
- C - ALLOWED - CHANNELIZATION DEVICES AND PCMS/ARROW, TMA, SPOTTER RECOMMENDED.

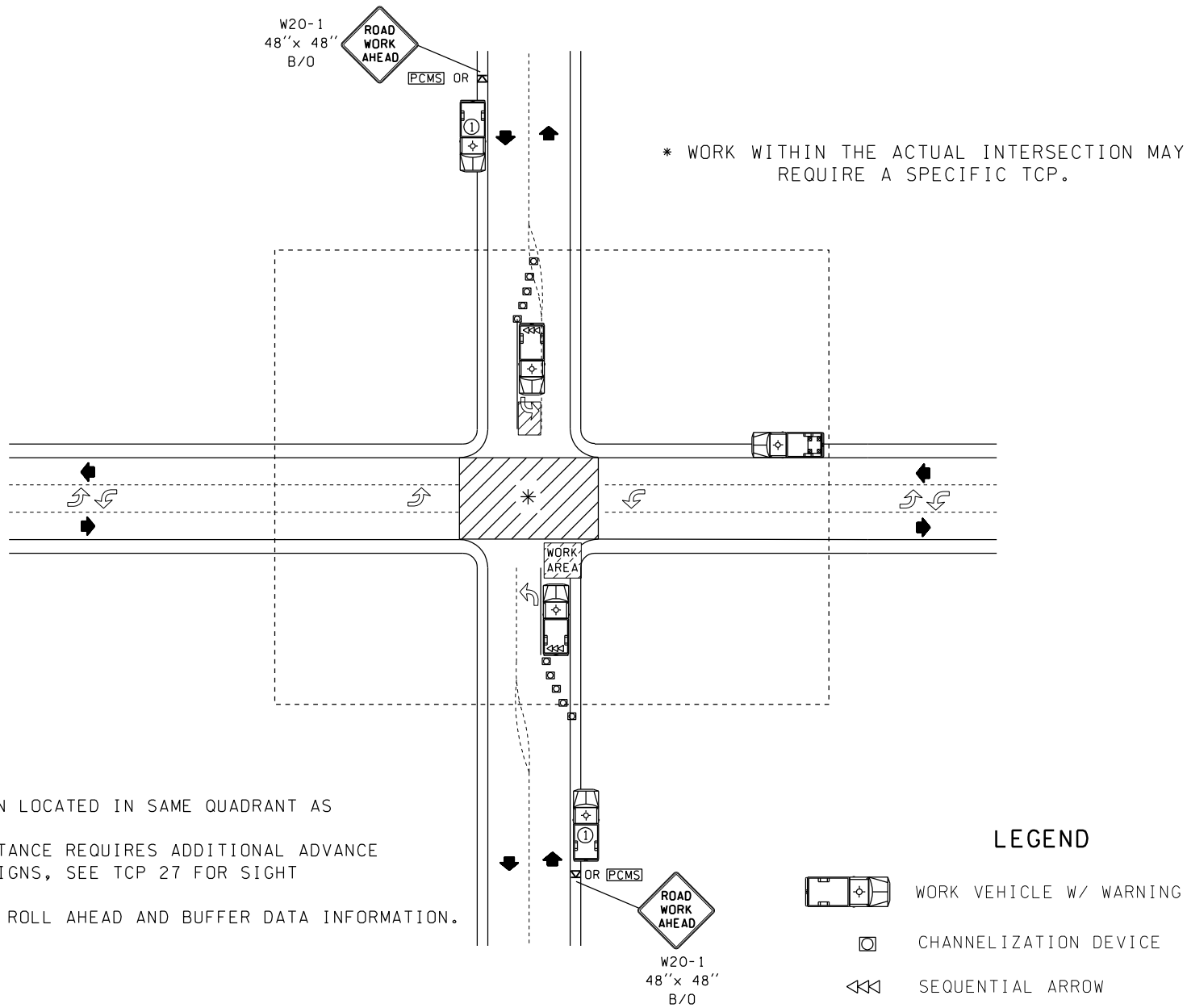

NOTES:

1. WORK VEHICLE W/BEACON LOCATED IN SAME QUADRANT AS WORK LOCATION.
2. RESTRICTED SIGHT DISTANCE REQUIRES ADDITIONAL ADVANCE WARNING DEVICES OR SIGNS, SEE TCP 27 FOR SIGHT DISTANCE CHART.
3. REFER TO PAGE 17 FOR ROLL AHEAD AND BUFFER DATA INFORMATION.

LEGEND

- WORK VEHICLE W/ WARNING BEACON
- CHANNELIZATION DEVICE
- SEQUENTIAL ARROW
- SIGN LOCATION
- PROTECTIVE VEHICLE #1 REQUIRED

TYPICAL SHORT DURATION WORK OPERATION
 INTERSECTION LOCATION
 (SEE GUIDANCE TEXT FOR ADDITIONAL DIRECTION)
 TCP 17

WORK ZONE CONDITION (SEE CONDITION GUIDANCE)

- A - ALLOWED - CONSIDER USING A SPOTTER
- B - ALLOWED - SPOTTER RECOMMENDED WORKER ACCESS TO LANE ALLOWED BASED ON SITE ASSESSMENT OF TRAFFIC CONDITIONS.
- C - NOT ALLOWED - SEE TCP 3 FOR WORK ZONE REQUIREMENTS.

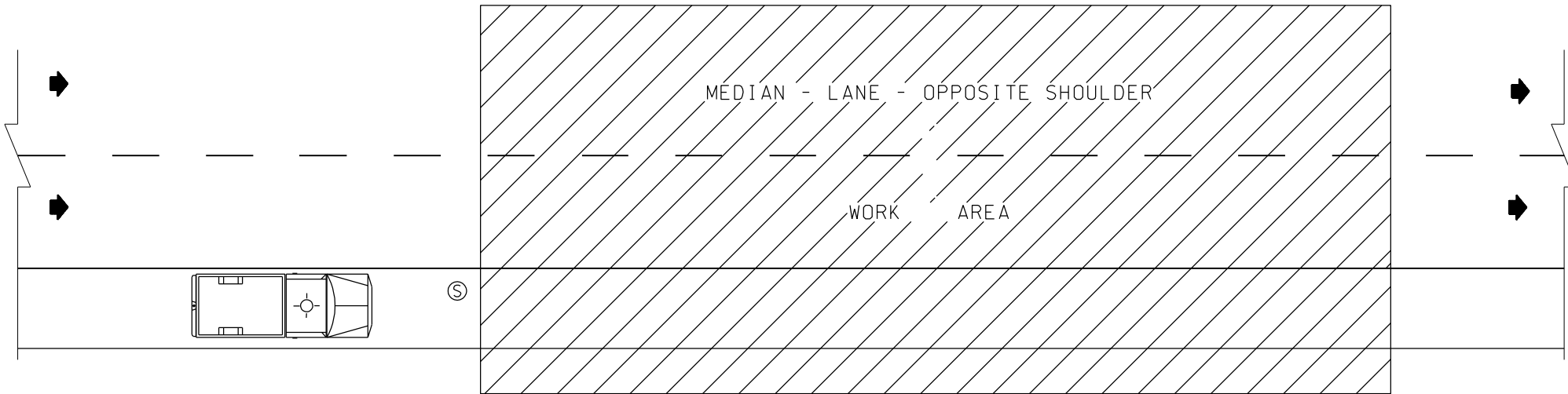

NOTES:

1. VERY SHORT WORK OPERATIONS MAY BE CONDUCTED AT VARIOUS LOCATIONS OR A WORKER MAY WALK TO THOSE LOCATIONS AS PART OF THE WORK OPERATION.
2. RESTRICTED SIGHT DISTANCE REQUIRES ADDITIONAL ADVANCE WARNING DEVICES OR SIGNS, SEE TCP 27 FOR SIGHT DISTANCE CHART.
3. REFER TO PAGE 17 FOR ROLL AHEAD AND BUFFER DATA INFORMATION.

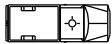

** ROADWAY EXAMPLE REPRESENTS - LEFT OR RIGHT SHOULDERS, MEDIAN OR GORE AREA

LEGEND

-  WORK VEHICLE W/ WARNING BEACON
-  SPOTTER

WORK ZONE CONDITION (SEE CONDITION GUIDANCE)

- A - ALLOWED - CONSIDER USING A SPOTTER
- B - ALLOWED - SPOTTER RECOMMENDED WORKER ACCESS TO LANE ALLOWED BASED ON SITE ASSESSMENT OF TRAFFIC CONDITIONS.
- C - NOT ALLOWED - SEE TCP 15 FOR WORK ZONE REQUIREMENTS.

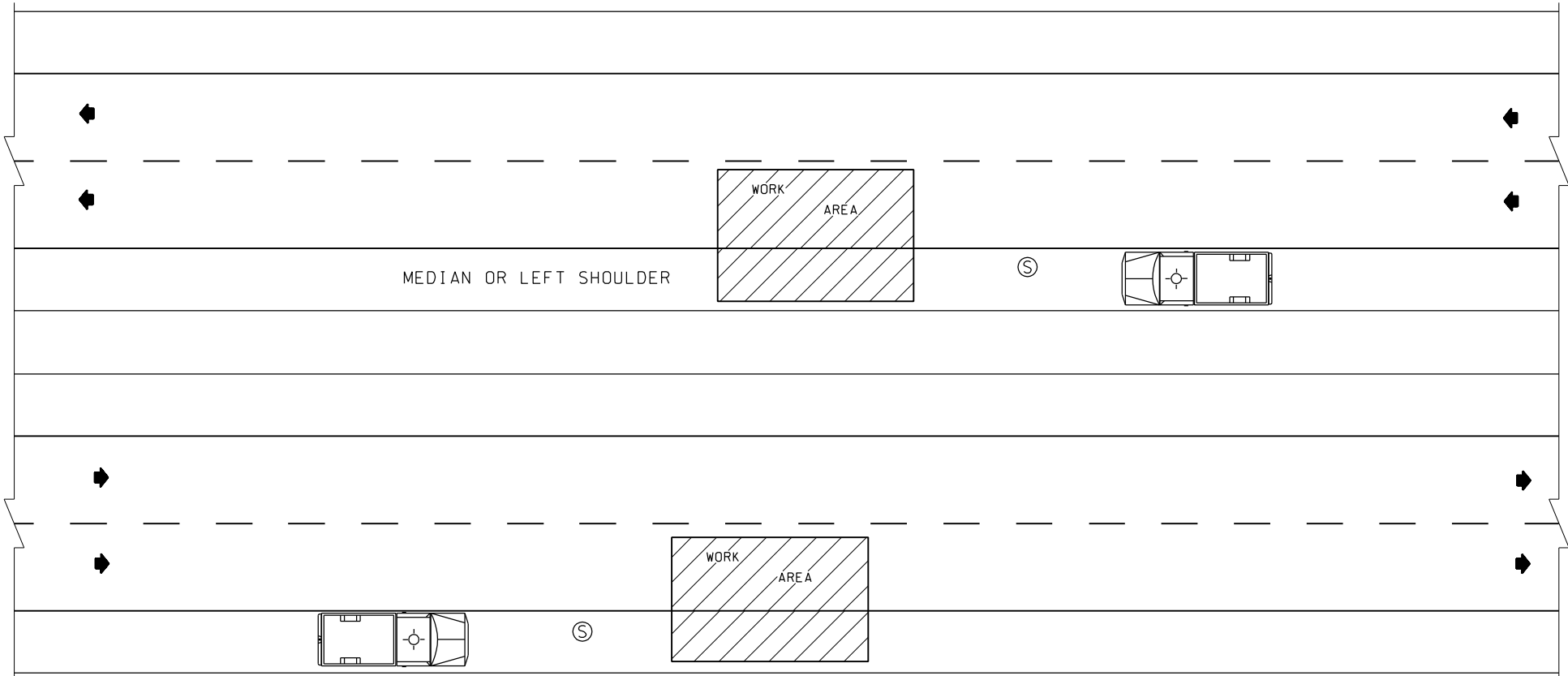

NOTES:

1. WORKER(S) MUST MOVE TO SHOULDER ADJACENT TO WORK LANE IF TRAFFIC APPROACHES PRIOR TO COMPLETION OF WORK.
2. REPEATED ACCESS TO WORK LANE NOT ALLOWED. SEE TCP 15 FOR WORK ZONE REQUIREMENTS - CONDITION "C".
3. RESTRICTED SIGHT DISTANCE REQUIRES ADDITIONAL ADVANCE WARNING DEVICES OR SIGNS, SEE TCP 27 FOR SIGHT DISTANCE CHART.
4. REFER TO PAGE 17 FOR ROLL AHEAD AND BUFFER DATA INFORMATION.

LEGEND

Ⓢ SPOTTER

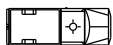

WORK VEHICLE W/ WARNING BEACON

TYPICAL VERY SHORT DURATION WORK OPERATION
(SEE GUIDANCE TEXT FOR ADDITIONAL DIRECTION)
TCP 19

WORK ZONE CONDITION (SEE CONDITION GUIDANCE)

- A - ALLOWED - CONSIDER SPOTTER, WORKER ACCESS TO OR ACROSS LANE(S) ALLOWED BASED ON SITE ASSESSMENT OF TRAFFIC CONDITIONS.
- B - ALLOWED - SPOTTER RECOMMENDED CONSIDER ADDITIONAL WARNING.
- C - NOT ALLOWED - SEE TCP 28 & 29 FOR WORK ZONE REQUIREMENTS.

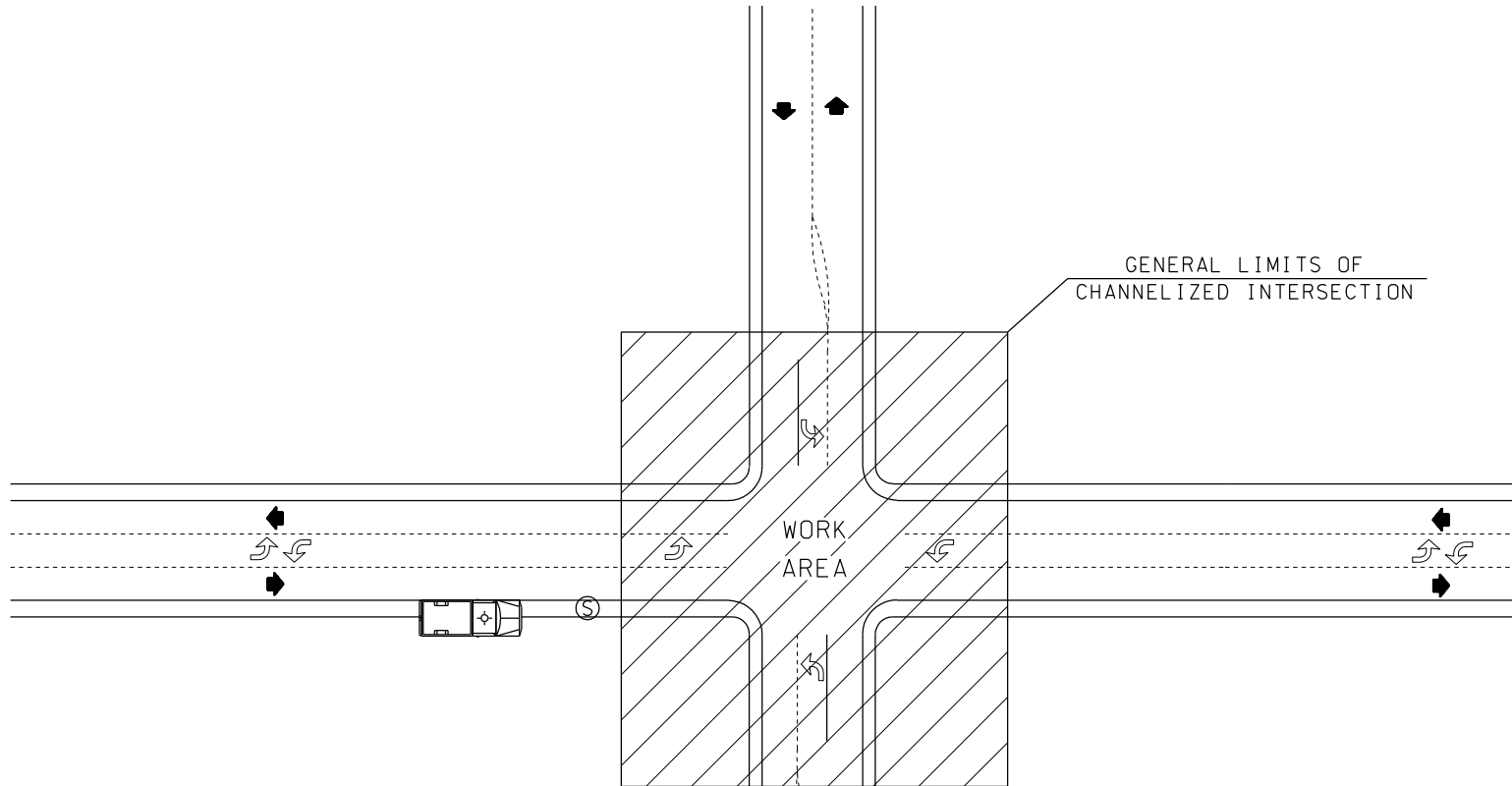

NOTES:

1. WORK VEHICLE W/BEACON LOCATED IN SAME QUADRANT AS WORK LOCATION.
2. REPEATED ACCESS TO WORK LANE NOT ALLOWED. SEE TCP FOR WORK ZONE REQUIREMENTS - CONDITION "C".
3. RESTRICTED SIGHT DISTANCE REQUIRES ADDITIONAL ADVANCE WARNING DEVICES OR SIGNS, SEE TCP 27 FOR SIGHT DISTANCE DATA.
4. RECOMMEND WORKING DURING APPROPRIATE RED PHASE IF SIGNALIZED.
5. REFER TO PAGE 17 FOR ROLL AHEAD AND BUFFER DATA INFORMATION.

LEGEND

-  WORK VEHICLE W/ WARNING BEACON
-  SPOTTER

TYPICAL VERY SHORT DURATION WORK OPERATION
 INTERSECTION LOCATION
 (SEE GUIDANCE TEXT FOR ADDITIONAL DIRECTION)
 TCP 20

ROLLING SLOWDOWN

Traffic Control Plan (TCP) 21

A rolling slowdown is a legitimate form of traffic control commonly practiced by the WSP, contractors and highway maintenance crews. This use is valuable for emergency, or **very specific** short duration closures (e.g. to set bridge girders, pick debris from the roadway, to push a blocking disabled to the shoulder, or to pull power lines across the roadway). The traffic control vehicles form a moving blockade, which reduces traffic speeds and creates a large gap in traffic, or clear area, allowing very short-term work to be accomplished without completely stopping the traffic.

Other traditional forms of traffic control should be considered first and be the primary choice when possible. If the slowdown is to be a scheduled operation, then the Regional Traffic Office needs to be contacted with a work request so a site specific traffic control plan (TCP) can be developed and/or reviewed and approved. The gap in traffic created by the rolling slowdown, and other traffic issues, should be addressed on an approved TCP. Also, use of WSP is encouraged whenever possible, at a minimum coordination is necessary.

In the event of debris in the roadway, a blocking disabled vehicle, or other emergency, the use of experience and resources at hand, along with sound judgment and common sense, will suffice in lieu of an approved, site specific, TCP. TCP 21 on page 54 has been developed as a guideline to represent the basic requirements for performing a safe and effective rolling slowdown. Site specific TCP's can be developed based on this plan.

Equipment availability is a prime consideration. Before starting this operation, ensure there are at least one traffic control vehicle (with flashing amber lights) per lane to be slowed, **and** one vehicle to cover every point of access onto the 'rolling slowdown' segment of roadway. (Only during emergencies should less than one traffic control vehicle per lane be considered.) Truck mounted PCMS boards stating, "Slow or Stopped Vehicles" or "Rolling Slowdown In Progress" are very helpful. **Be sure that every crewmember participating is well briefed and knows what is needed from them. Good communications for this operation are essential!**

The traffic control vehicles leading the rolling slowdown must enter the roadway far enough upstream from the work operation site to allow a clear area in front of them to develop. The traffic control vehicles will work into position so that each lane is controlled. As in every other form of traffic control, sight distance is important, so that drivers are not surprised. While traveling at a fixed and reduced rate of speed, a gap in traffic must be created which is long enough to provide the estimated time needed for the work to be done.

A separate traffic control vehicle, "chase vehicle", shall follow the slowest, or last, vehicle ahead of the blockade. When that last vehicle passes, the crew can begin the work operation.

All ramps and entrances to the roadway between the moving blockade and work operation must be temporarily closed using traffic control equipment and personnel. Each of those ramps must remain closed until the crew doing the work gives the "all clear" signal, **or** until the front of the moving blockade passes the closed on-ramp(s).

Radio communications between the work crew and the moving blockade are required so the speed of the blockade can be adjusted, if necessary, to increase or decrease the closure time. Release traffic only after you have confirmation that all workers and their vehicles are clear of the roadway.

THIS PLAN DEPICTS THE MINIMUM REQUIREMENTS TO PERFORM AN EMERGENCY ROLLING SLOWDOWN. IF THE SLOWDOWN IS, OR CAN BE, A PLANNED EVENT, THEN A SITE SPECIFIC TRAFFIC CONTROL PLAN SHOULD BE DEVELOPED AND APPROVED BY THE REGION TRAFFIC OFFICE PRIOR TO THE OPERATION OCCURRING.

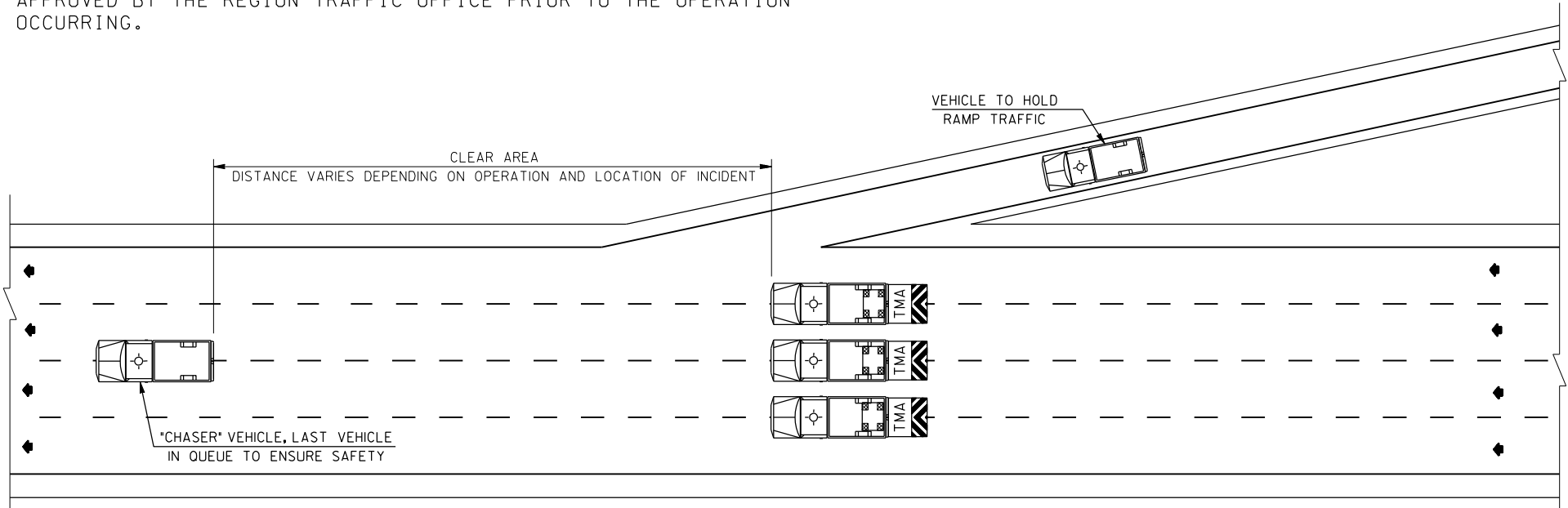

(SAMPLE MESSAGE)

TRUCK MOUNTED PCMS	
1	2
SLOW OR STOPPED VEHICLES	DO NOT PASS
1.5 SEC	1.5 SEC

LEGEND



TRUCK MOUNTED ATTENUATOR (RECOMMENDED)



WARNING BEACON



SEQUENTIAL ARROW - CAUTION MODE (REQUIRED)

OPERATIONAL NOTES

1. ALL WORK VEHICLES SHALL USE WARNING BEACONS.
2. THE NUMBER OF VEHICLES SHOWN IS A MINIMUM. IF POSSIBLE USE ONE VEHICLE PER LANE DURING CLOSURE.
3. WSP SHALL BE NOTIFIED AND ON SITE WHEN AVAILABLE.
4. ALL ON-RAMP TRAFFIC SHALL BE STOPPED DURING SLOWDOWN.

TYPICAL ROLLING SLOWDOWN
TCP 21

MOBILE WORK ZONES

Traffic Control Plans (TCP's) 22 to 27

Mobile work zones are work activities that typically move along the road either intermittently or continuously. Frequent short stops may be used for pothole patching, litter cleanup, herbicide spraying, lane marker replacement or other similar operations. Channelizing devices, truck mounted signs or Portable Changeable Message Signs (PCMS), warning lights and flaggers may be needed for these operations.

Mobile work zones also include slow moving operations where workers and equipment move along the road without stopping. Operations such as sweeping and paint striping are typical mobile operations. The warning signs move ahead with the work, usually mounted on a shadow vehicle. Truck mounted signs or PCMS, Truck Mounted Attenuator (TMA) and warning lights are some of the devices that may be used for moving operations. Messages for truck mounted PCMS's should conform to standard work messages whenever possible. Contact the Region Traffic Office Staff for assistance with selecting appropriate messages.

Mobile work zones are well suited to maintenance operations and can be an efficient way to accomplish many types of work, but due to the moving nature of these operations it is imperative that the crew is carefully coordinated. Careful consideration of traffic and roadway conditions as they relate to the specific operation must be done prior to starting work.

The following TCP's show typical examples of mobile work zones.

Many work operations that may have been previously conducted as short-term operations can be significantly improved by converting to a mobile operation. Contact the region traffic office for assistance.

TYPICAL FREEWAY APPLICATION
(ACTUAL NUMBER OF LANES MAY VARY)

(JANUARY 2005) Work Zone Traffic Control Guidelines

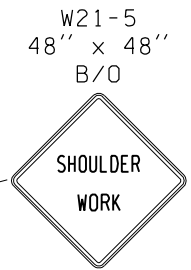
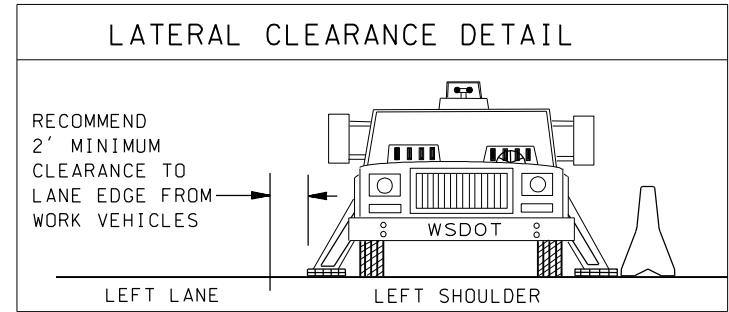
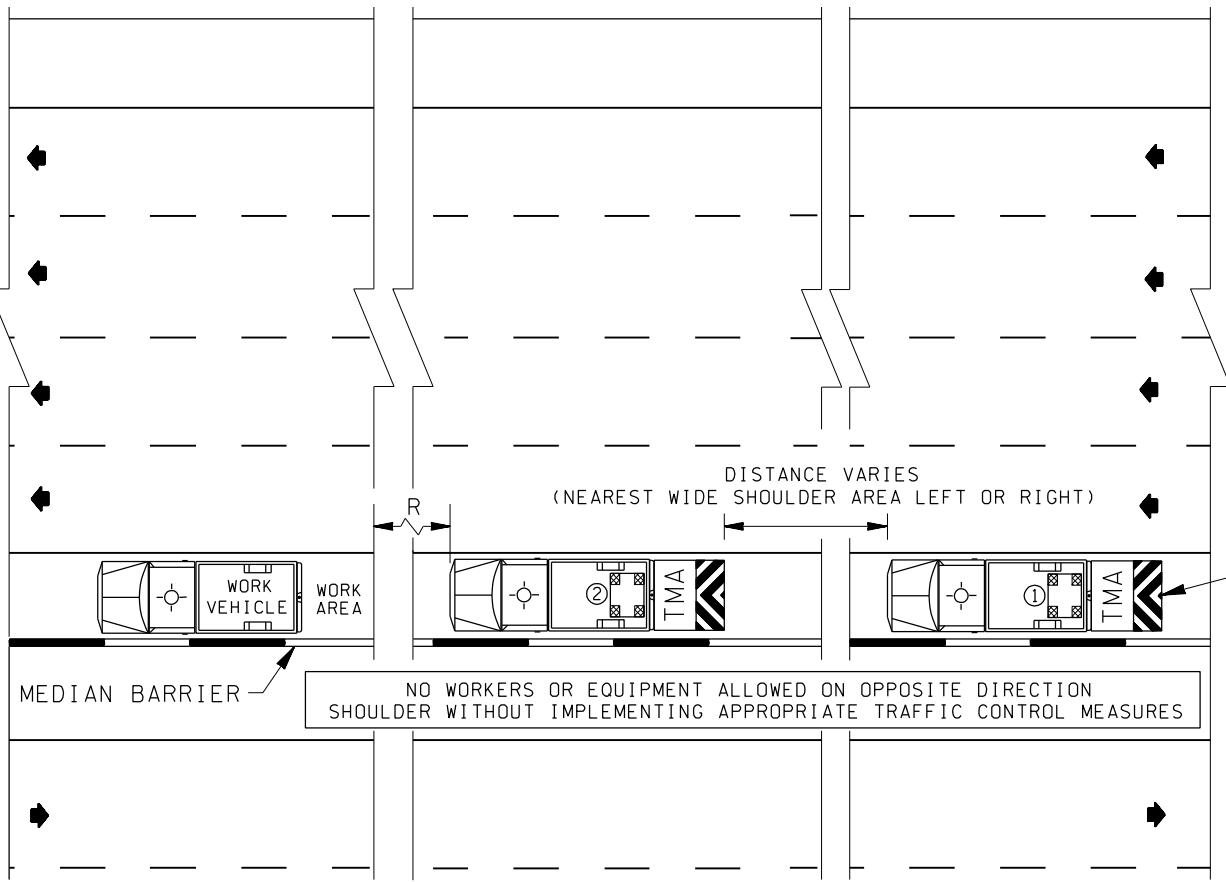

(SAMPLE MESSAGE)

PCMS	
1	2
LEFT SHOULDER CLOSED	SLOW MOVING VEHICLES
1.5 SEC	1.5 SEC

Field locate in advance of lane closure.
(TRUCK MOUNTED OR TRAILER MOUNTED OPTIONAL)

PROTECTIVE VEHICLE ROLL AHEAD DISTANCE = R



ROLL AHEAD DISTANCES VARY AND SHALL BE DETERMINED IN FIELD BASED ON WORK OPERATION AND SITE SPECIFIC CONDITIONS.

USE OF A TRUCK MOUNTED ATTENUATOR RECOMMENDED

OPERATIONAL NOTES

1. SHADOW VEHICLE #1, MOUNT SHOULDER CLOSURE SIGN ON BACK OF VEHICLE. DO NOT OBSCURE SEQUENTIAL ARROW PANEL. MAINTAIN 1000' TO 1500' OF SIGHT DISTANCE TO APPROACHING TRAFFIC (TMA RECOMMENDED).
2. PROTECTIVE VEHICLE #2, POSITION VEHICLE TO PROVIDE PROTECTION OF CREW. MAINTAIN ROLL-AHEAD DISTANCE (TMA RECOMMENDED).
3. 2' MINIMUM CLEARANCE RECOMMENDED BETWEEN LANE EDGE AND WORK VEHICLE. ADJACENT LANE MUST BE CLOSED IF ADDITIONAL CLEARANCE IS REQUIRED OR IF WORK ACTIVITIES ADVERSELY INFLUENCE TRAFFIC.
4. CONTACT REGION TRAFFIC MANAGEMENT CENTER PRIOR TO WORK BEGIN AND END.
5. PCMS RECOMMENDED.

LEGEND

-  SEQUENTIAL ARROW PANEL - TYPE "B" (CAUTION MODE)
-  TRUCK MOUNTED ATTENUATOR
-  WARNING BEACON - REQUIRED

MOBILE FREEWAY OPERATION
LEFT SHOULDER CLOSED
TCP 22

(SAMPLE MESSAGE)

PCMS	
1	2
LEFT LANE CLOSED	MERGE RIGHT
1.5 SEC	1.5 SEC

Field locate in advance of lane closure.
(TRUCK MOUNTED OR TRAILER MOUNTED OPTIONAL)

PROTECTIVE VEHICLE ROLL AHEAD DISTANCE = R
ROLL AHEAD DISTANCES VARY AND SHALL BE DETERMINED IN FIELD BASED ON WORK OPERATION AND SITE SPECIFIC CONDITIONS.
USE OF A TRUCK MOUNTED ATTENUATOR RECOMMENDED

TYPICAL FREEWAY APPLICATION
(ACTUAL NUMBER OF LANES MAY VARY)

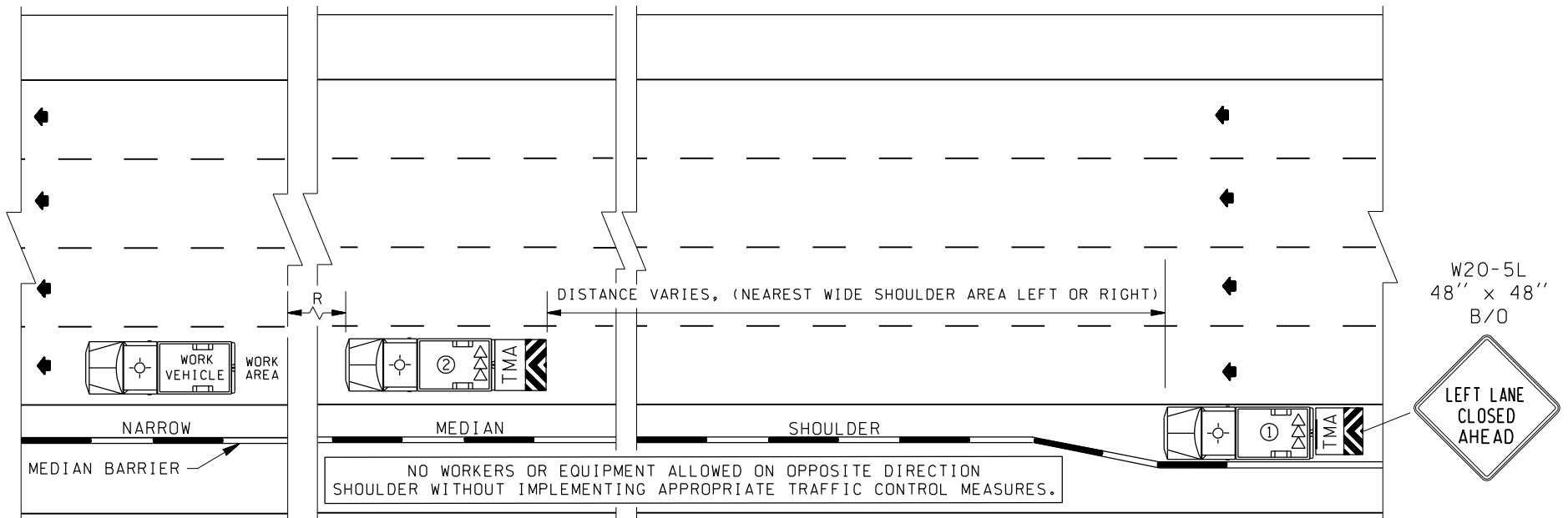

OPERATIONAL NOTES

1. SHADOW VEHICLE #1, MOUNT LANE CLOSURE SIGN ON BACK OF VEHICLE. DO NOT OBSCURE SEQUENTIAL ARROW PANEL. MAINTAIN 1000' TO 1500' OF SIGHT DISTANCE TO APPROACHING TRAFFIC (TMA RECOMMENDED).
2. PROTECTIVE VEHICLE #2, POSITION VEHICLE TO PROVIDE PROTECTION OF CREW. MAINTAIN ROLL AHEAD DISTANCE (TMA RECOMMENDED).
3. 2' MINIMUM CLEARANCE RECOMMENDED BETWEEN LANE EDGE AND WORK VEHICLE. ADJACENT LANE MUST BE CLOSED IF ADDITIONAL CLEARANCE IS REQUIRED OR IF WORK ACTIVITIES ADVERSELY INFLUENCE TRAFFIC.
4. CONTACT REGION TRAFFIC MANAGEMENT CENTER PRIOR TO WORK BEGINS AND AFTER ENDING.
5. PCMS RECOMMENDED.

LEGEND

SEQUENTIAL ARROW PANEL - TYPE "B" MIN.

TRUCK MOUNTED ATTENUATOR

WARNING BEACON - REQUIRED

PROTECTIVE VEHICLE ROLL AHEAD DISTANCE = R
 ROLL AHEAD DISTANCES VARY AND SHALL BE DETERMINED IN FIELD BASED
 ON WORK OPERATION AND SITE SPECIFIC CONDITIONS.
 USE OF A TRUCK MOUNTED ATTENUATOR RECOMMENDED

TYPICAL FREEWAY APPLICATION
 (ACTUAL NUMBER OF LANES MAY VARY)

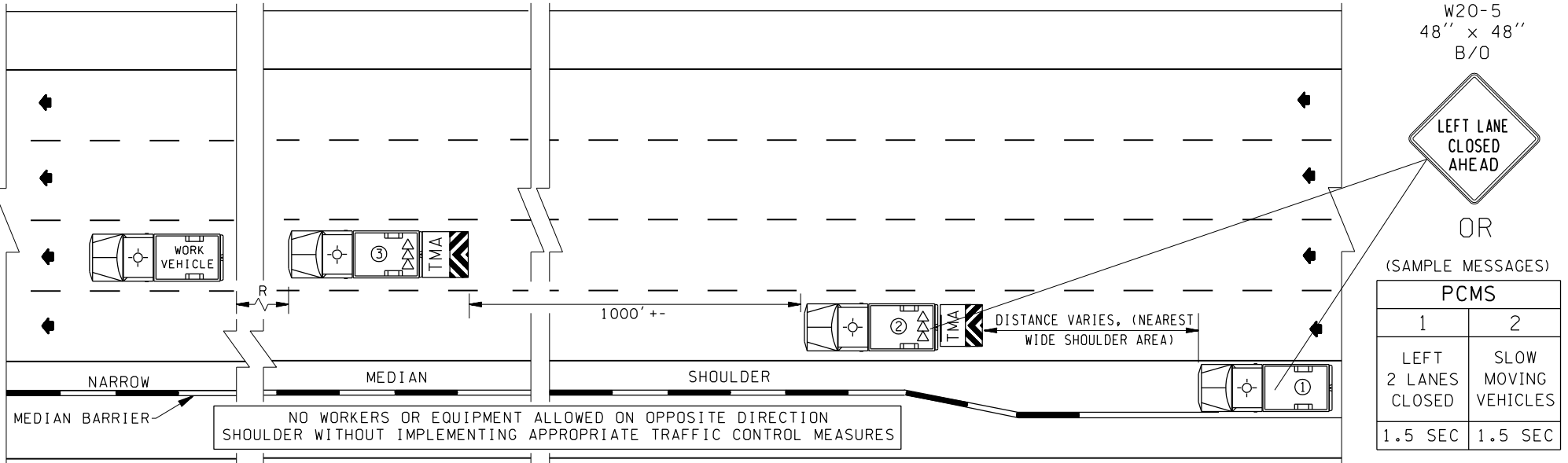

OPERATIONAL NOTES

1. ADVANCE WARNING VEHICLE #1, MOUNT LANE CLOSURE SIGN ON BACK OF VEHICLE. MAINTAIN 1000' TO 1500' SIGHT DISTANCE TO APPROACHING VEHICLES. (TMA RECOMMENDED)
2. SHADOW VEHICLE #2, MOUNT LANE CLOSURE SIGN ON BACK OF VEHICLE. DO NOT OBSCURE SEQUENTIAL ARROW PANEL. MAINTAIN 1000' TO 1500' OF SIGHT DISTANCE TO APPROACHING TRAFFIC (TMA RECOMMENDED).
3. PROTECTIVE VEHICLE #3, POSITION VEHICLE TO PROVIDE PROTECTION OF CREW. MAINTAIN ROLL AHEAD DISTANCE (TMA RECOMMENDED).
4. 2' MINIMUM CLEARANCE RECOMMENDED BETWEEN LANE EDGE AND WORK VEHICLE. ADJACENT LANE MUST BE CLOSED IF ADDITIONAL CLEARANCE IS REQUIRED OR IF WORK ACTIVITIES ADVERSELY INFLUENCE TRAFFIC.
5. CONTACT REGION TRAFFIC MANAGEMENT CENTER PRIOR TO WORK BEGIN AND END.
6. PCMS RECOMMENDED.

LEGEND

▷▷ SEQUENTIAL ARROW PANEL - TYPE "B" MIN.

TMA TRUCK MOUNTED ATTENUATOR (RECOMMENDED)

⊕ WARNING BEACON - REQUIRED

MOBILE FREEWAY OPERATION
 MIDDLE LANE WORK AREA
 TCP 24

PROTECTIVE VEHICLE ROLL AHEAD DISTANCE = R
 ROLL AHEAD DISTANCES VARY AND SHALL BE DETERMINED IN FIELD BASED ON WORK OPERATION AND SITE SPECIFIC CONDITIONS.
 USE OF A TRUCK MOUNTED ATTENUATOR RECOMMENDED

PCMS	
1	2
SLOW MOVING VEHICLE	YIELD TO ONCOMING TRAFFIC
1.5 SEC	1.5 SEC

TRUCK MOUNTED PCMS (OPTIONAL)

R4-1
 36" x 48"
 B/W
 (OPTIONAL)
 MOUNT ON PROTECTIVE VEHICLE

OR

SP-1
 36" x 48"
 R/W
 (OPTIONAL)

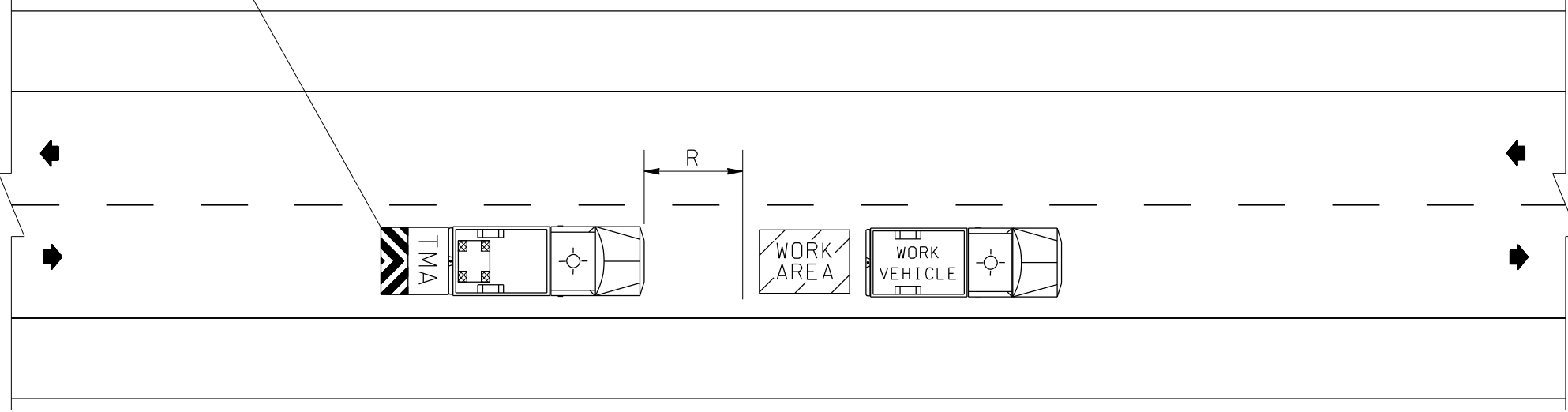

OPERATIONAL NOTES

1. WORK VEHICLE AND PROTECTIVE VEHICLE SHALL USE WARNING BEACONS.
2. PROTECTIVE VEHICLE SHALL MAINTAIN 500'-1000' OF SIGHT DISTANCE TO APPROACHING TRAFFIC.
3. CONTACT REGIONAL TRAFFIC OFFICE STAFF FOR ASSISTANCE WITH SPECIFIC IN LANE OPERATIONS SUCH AS STRIPING, FOG SEAL, ETC. THAT REQUIRE ADDITIONAL PLANS AND DETAILS.
4. "DO NOT PASS" SIGN CAN BE REPLACED WITH "PASS WITH CARE" SIGN WHEN APPROPRIATE.
5. PCMS RECOMMENDED.

LEGEND

- SEQUENTIAL ARROW PANEL - TYPE "B" (CAUTION MODE)
- TRUCK MOUNTED ATTENUATOR (RECOMMENDED)
- WARNING BEACON

TYPICAL MOBILE OPERATION
 TWO LANE ROADWAY
 LANE CLOSURE
 TCP 25

PROTECTIVE VEHICLE ROLL AHEAD DISTANCE = R
ROLL AHEAD DISTANCES VARY AND SHALL BE DETERMINED IN FIELD BASED ON WORK OPERATION AND SITE SPECIFIC CONDITIONS.
USE OF A TRUCK MOUNTED ATTENUATOR RECOMMENDED

W21-5
48" x 48"
B/O

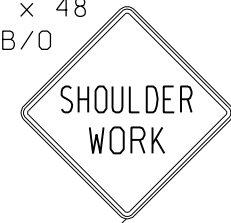

MOUNT ON SHADOW VEHICLE

(NO ENCROACHMENT INTO TRAFFIC LANE)

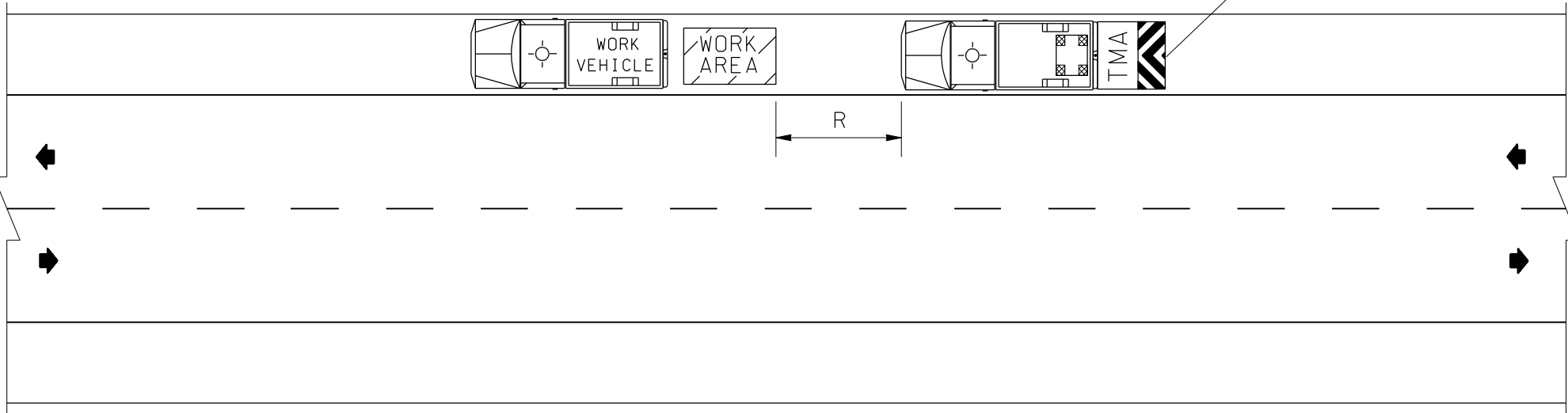
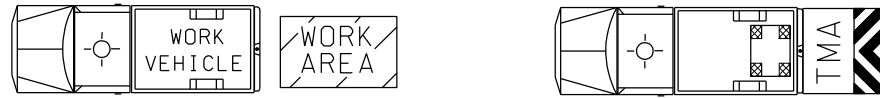

OPERATIONAL NOTES

1. WORK VEHICLE AND PROTECTIVE VEHICLE SHALL USE WARNING BEACONS.
2. PROTECTIVE VEHICLE SHALL MAINTAIN 500'-1000' OF SIGHT DISTANCE TO APPROACHING TRAFFIC.
3. CONTACT REGIONAL TRAFFIC OFFICE STAFF FOR ASSISTANCE WITH SPECIFIC IN LANE OPERATIONS SUCH AS STRIPING, FOG SEAL, ETC. THAT REQUIRE ADDITIONAL PLANS AND DETAILS.

LEGEND

 SEQUENTIAL ARROW PANEL - TYPE "B" (CAUTION MODE)

 TRUCK MOUNTED ATTENUATOR (RECOMMENDED)

 WARNING BEACON

TYPICAL MOBILE OPERATION
TWO LANE ROADWAY
SHOULDER CLOSURE
TCP 26

SIGHT DISTANCE DATA									
MIN. STOPPING SIGHT DIST. = S									
SPEED LIMIT MPH	25	30	35	40	45	50	55	60	65
DISTANCE FEET	55	85	120	170	220	280	335	415	485
DISTANCES SHOWN ARE MINIMUMS, USE ADDITIONAL DISTANCE WHEN POSSIBLE.									

W21-1
48" x 48"
B/O



WORKERS

MOUNT TO BACK OF WORK VEHICLE
OR
OTHER APPROPRIATE WARNING SIGNS

SHADOW VEHICLE MAINTAIN MIN. SIGHT DISTANCE "S" (SEE CHART) TO APPROACHING TRAFFIC.

W20-1
48" x 48"
B/O



ROAD
WORK
AHEAD

MOUNT TO BACK
OF SHADOW VEHICLE

OR

(SAMPLE MESSAGE)

PCMS	
1	2
WORKERS ON ROADWAY	BE PREPARED TO STOP
1.5 SEC	1.5 SEC

TRUCK MOUNTED PCMS

CRITICAL SIGHT
DISTANCE
AREA

CRITICAL SIGHT
DISTANCE
AREA

LEGEND

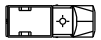

WORK VEHICLE WITH FLASHING AMBER WARNING BEACON



SHADOW VEHICLE WITH FLASHING AMBER WARNING BEACON
(TMA RECOMMENDED, BUT NOT REQUIRED)

GENERAL NOTES

1. DAYLIGHT HOURS ONLY.
2. RADIO CONTACT BETWEEN WORK CREW AND SHADOW VEHICLE REQUIRED.
3. PCMS RECOMMENDED.

INTERSECTION OPERATIONS

Traffic Control Plans (TCP's) 28 to 30

Traffic control at intersections requires specific attention because traffic is usually in-bound from all directions. The traffic on all approaches needs to be given the same advance warning with the messages on the warning signs to be appropriate for the situation ahead of them. When an intersection is to be controlled by flaggers, always be sure that an existing signal does not give the drivers a conflicting message. For example, don't stop traffic when the signal is green. It is always best to turn off the signal during flagging operations.

The traffic control plans in this section show a pair of rather complex intersections. In general, use these examples as guidelines and prepare specific traffic control plans for the intersections you will be working in, showing the lanes and turning movements as they appear on the roadway.

BUFFER DATA

LONGITUDINAL BUFFER SPACE = B										
SPEED (MPH)	25	30	35	40	45	50	55	60	65	70
LENGTH (feet)	55	85	120	170	220	280	335	415	-	-
PROTECTIVE VEHICLE WITH TMA ROLL AHEAD DISTANCE										
TYPICAL PROTECTIVE VEHICLE TYPE WITH TMA	TYPICAL PROTECTIVE VEHICLE (WITH TMA) LOADED WEIGHT (LBS)						STATIONARY OPERATION (feet)			
4 YARD DUMP TRUCK, SERVICE TRUCK, FLAT BED, ETC.	MINIMUM WEIGHT 15,000 LBS. (MAXIMUM WEIGHT SHALL BE IN ACCORDANCE WITH MANUFACTURER RECOMMENDATION)						30 MIN			
ROLL AHEAD STOPPING DISTANCE ASSUMES DRY PAVEMENT										
* A PROTECTIVE VEHICLE IS RECOMMENDED REGARDLESS IF A TMA IS AVAILABLE. IF NO TMA IS USED, THE PROTECTIVE VEHICLE SHALL BE STRATEGICALLY LOCATED IN THE FIELD TO SHIELD WORKERS AND NO ROLL AHEAD DISTANCE IS SPECIFIED.										

LANE WIDTH (feet)	MINIMUM TAPER LENGTH = L (feet)									
	Posted Speed (mph)									
10	25	30	35	40	45	50	55	60	65	70
	105	150	205	270	450	500	550	-	-	-
11	115	165	225	295	495	550	605	660	-	-
	125	180	245	320	540	600	660	720	-	-

SIGN SPACING = X (feet)		
Rural Highways	60/65 MPH	1000'+-
Rural Roads	45/55 MPH	500'+-
Rural Roads & Urban Arterials	35/40 MPH	350'+-
Rural Roads, Urban Streets Residential & Business Districts	25/30 MPH	200'+-
Urban Streets	25 MPH or LESS	100'+-

ALL SIGNS ARE 48" x 48" BLACK ON ORANGE UNLESS OTHERWISE DESIGNATED.
All spacing may be adjusted to accommodate interchange ramps, at-grade intersections, and driveways.

CHANNELIZING DEVICE SPACING (feet)		
MPH	TAPER	TANGENT
50/70	40	80
35/45	30	60
25/30	20	40

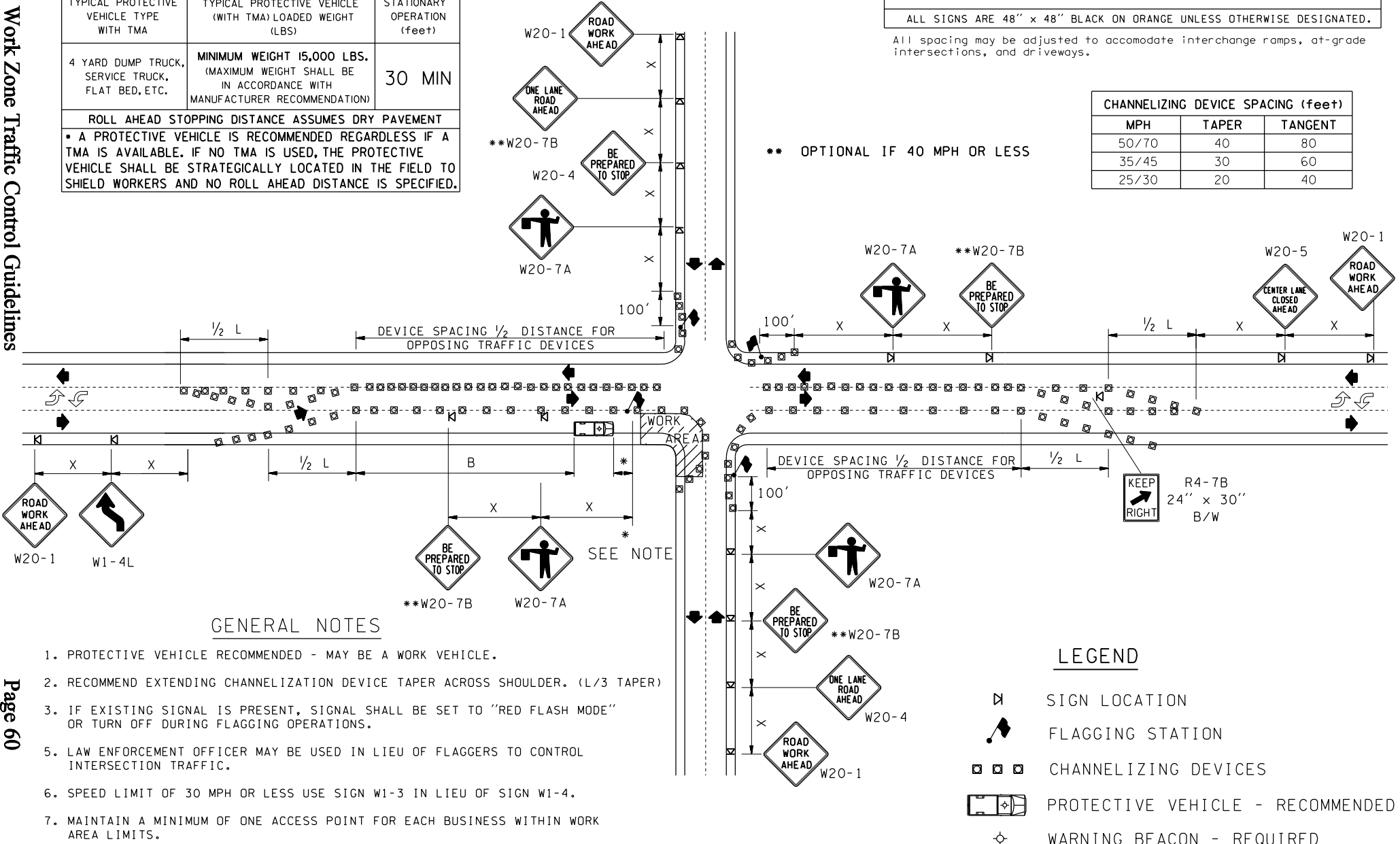

GENERAL NOTES

1. PROTECTIVE VEHICLE RECOMMENDED - MAY BE A WORK VEHICLE.
2. RECOMMEND EXTENDING CHANNELIZATION DEVICE TAPER ACROSS SHOULDER. (L/3 TAPER)
3. IF EXISTING SIGNAL IS PRESENT, SIGNAL SHALL BE SET TO "RED FLASH MODE" OR TURN OFF DURING FLAGGING OPERATIONS.
4. LAW ENFORCEMENT OFFICER MAY BE USED IN LIEU OF FLAGGERS TO CONTROL INTERSECTION TRAFFIC.
5. SPEED LIMIT OF 30 MPH OR LESS USE SIGN W1-3 IN LIEU OF SIGN W1-4.
6. MAINTAIN A MINIMUM OF ONE ACCESS POINT FOR EACH BUSINESS WITHIN WORK AREA LIMITS.

LEGEND

- SIGN LOCATION
- FLAGGING STATION
- CHANNELIZING DEVICES
- PROTECTIVE VEHICLE - RECOMMENDED
- WARNING BEACON - REQUIRED

**INTERSECTION LANE CLOSURE
TCP 28**

BUFFER DATA

LONGITUDINAL BUFFER SPACE = B

SPEED (MPH)	25	30	35	40	45	50	55	60	65	70
LENGTH (feet)	55	85	120	170	220	280	335	415	-	-

PROTECTIVE VEHICLE WITH TMA ROLL AHEAD DISTANCE

TYPICAL PROTECTIVE VEHICLE TYPE WITH TMA	TYPICAL PROTECTIVE VEHICLE (WITH TMA) LOADED WEIGHT (LBS)	STATIONARY OPERATION (feet)
4 YARD DUMP TRUCK, SERVICE TRUCK, FLAT BED, ETC.	MINIMUM WEIGHT 15,000 LBS. (MAXIMUM WEIGHT SHALL BE IN ACCORDANCE WITH MANUFACTURER RECOMMENDATION)	30 MIN

ROLL AHEAD STOPPING DISTANCE ASSUMES DRY PAVEMENT

• A PROTECTIVE VEHICLE IS RECOMMENDED REGARDLESS IF A TMA IS AVAILABLE. IF NO TMA IS USED, THE PROTECTIVE VEHICLE SHALL BE STRATEGICALLY LOCATED IN THE FIELD TO SHIELD WORKERS AND NO ROLL AHEAD DISTANCE IS SPECIFIED.

CHANNELIZING DEVICE SPACING (feet)		
MPH	TAPER	TANGENT
50/70	40	80
35/45	30	60
25/30	20	40

SIGN SPACING = X (feet)		
Rural Highways	60/65 MPH	1000'+-
Rural Roads	45/55 MPH	500'+-
Rural Roads & Urban Arterials	35/40 MPH	350'+-
Rural Roads, Urban Streets Residential & Business Districts	25/30 MPH	200'+-
Urban Streets	25 MPH or LESS	100'+-
ALL SIGNS ARE 48" x 48" BLACK ON ORANGE UNLESS OTHERWISE DESIGNATED.		

All spacing may be adjusted to accommodate interchange ramps, at-grade intersections, and driveways.

•• OPTIONAL IF 40 MPH OR LESS

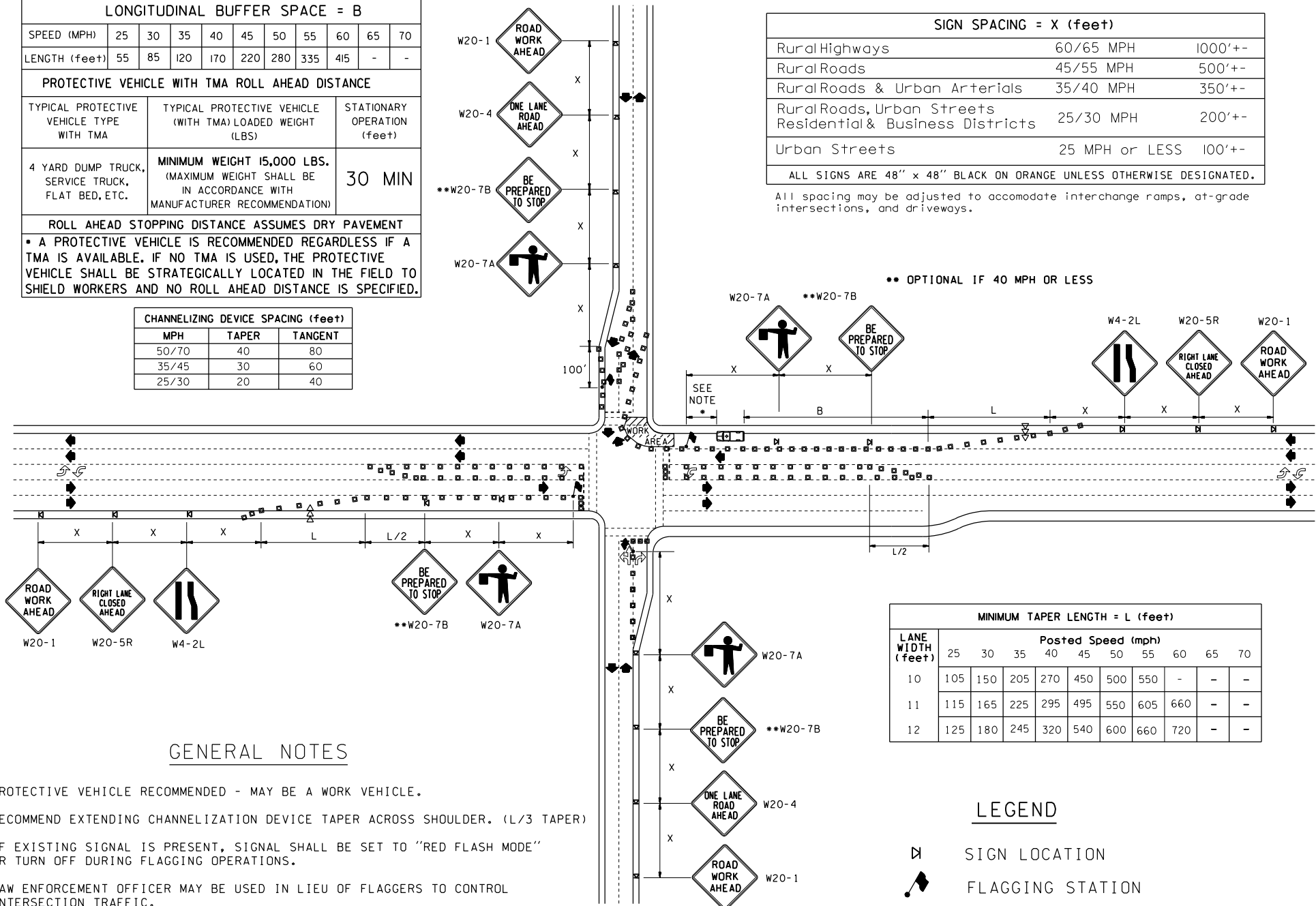

GENERAL NOTES

1. PROTECTIVE VEHICLE RECOMMENDED - MAY BE A WORK VEHICLE.
2. RECOMMEND EXTENDING CHANNELIZATION DEVICE TAPER ACROSS SHOULDER. (L/3 TAPER)
3. IF EXISTING SIGNAL IS PRESENT, SIGNAL SHALL BE SET TO "RED FLASH MODE" OR TURN OFF DURING FLAGGING OPERATIONS.
5. LAW ENFORCEMENT OFFICER MAY BE USED IN LIEU OF FLAGGERS TO CONTROL INTERSECTION TRAFFIC.
6. SPEED LIMIT OF 30 MPH OR LESS USE SIGN W1-3 IN LIEU OF SIGN W1-4.
7. MAINTAIN A MINIMUM OF ONE ACCESS POINT FOR EACH BUSINESS WITHIN WORK AREA LIMITS.

MINIMUM TAPER LENGTH = L (feet)										
LANE WIDTH (feet)	Posted Speed (mph)									
	25	30	35	40	45	50	55	60	65	70
10	105	150	205	270	450	500	550	-	-	-
11	115	165	225	295	495	550	605	660	-	-
12	125	180	245	320	540	600	660	720	-	-

LEGEND

- SIGN LOCATION
- FLAGGING STATION
- CHANNELIZING DEVICES
- SEQUENTIAL ARROW SIGN
- PROTECTIVE VEHICLE - RECOMMENDED
- WARNING BEACON - REQUIRED

INTERSECTION LANE CLOSURE TCP 29

* INSTALL ON TYPE II BARRICADES THROUGHOUT THE WORK AREA
 24 HOURS PRIOR TO IMPLEMENTING TRAFFIC CONTROL.
 PRIOR NOTIFICATION OF LOCAL LAW ENFORCEMENT REQUIRED.

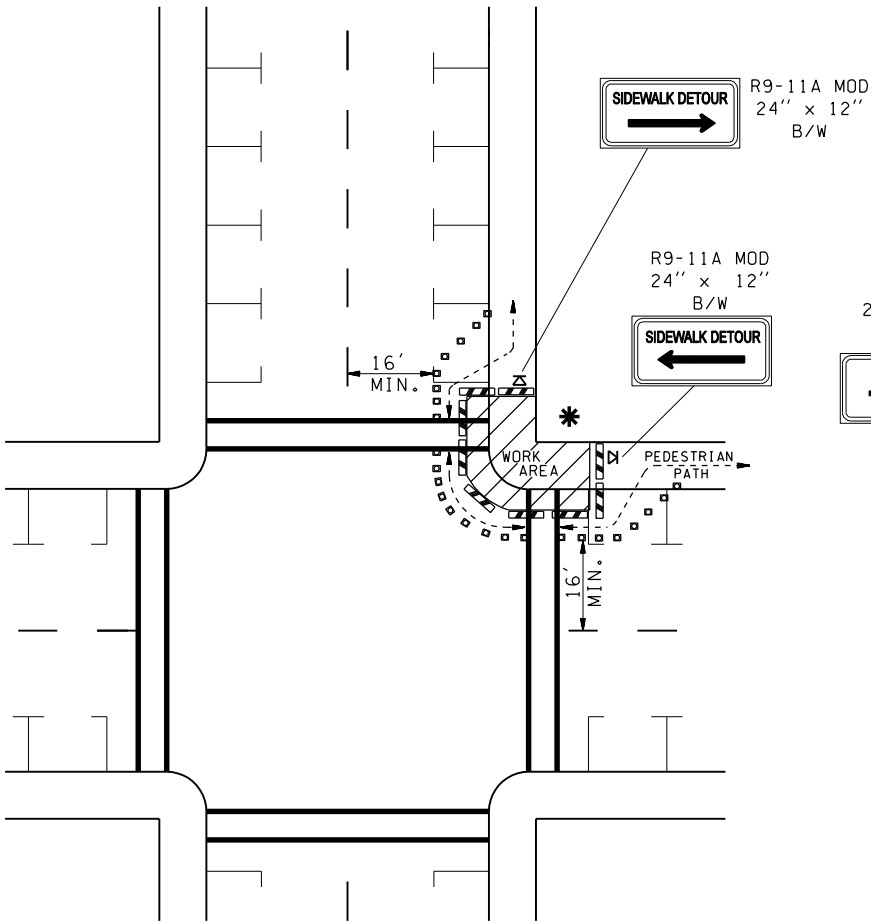
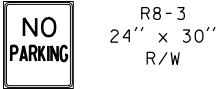

PEDESTRIAN DETOUR
(NONWORKING HOURS)

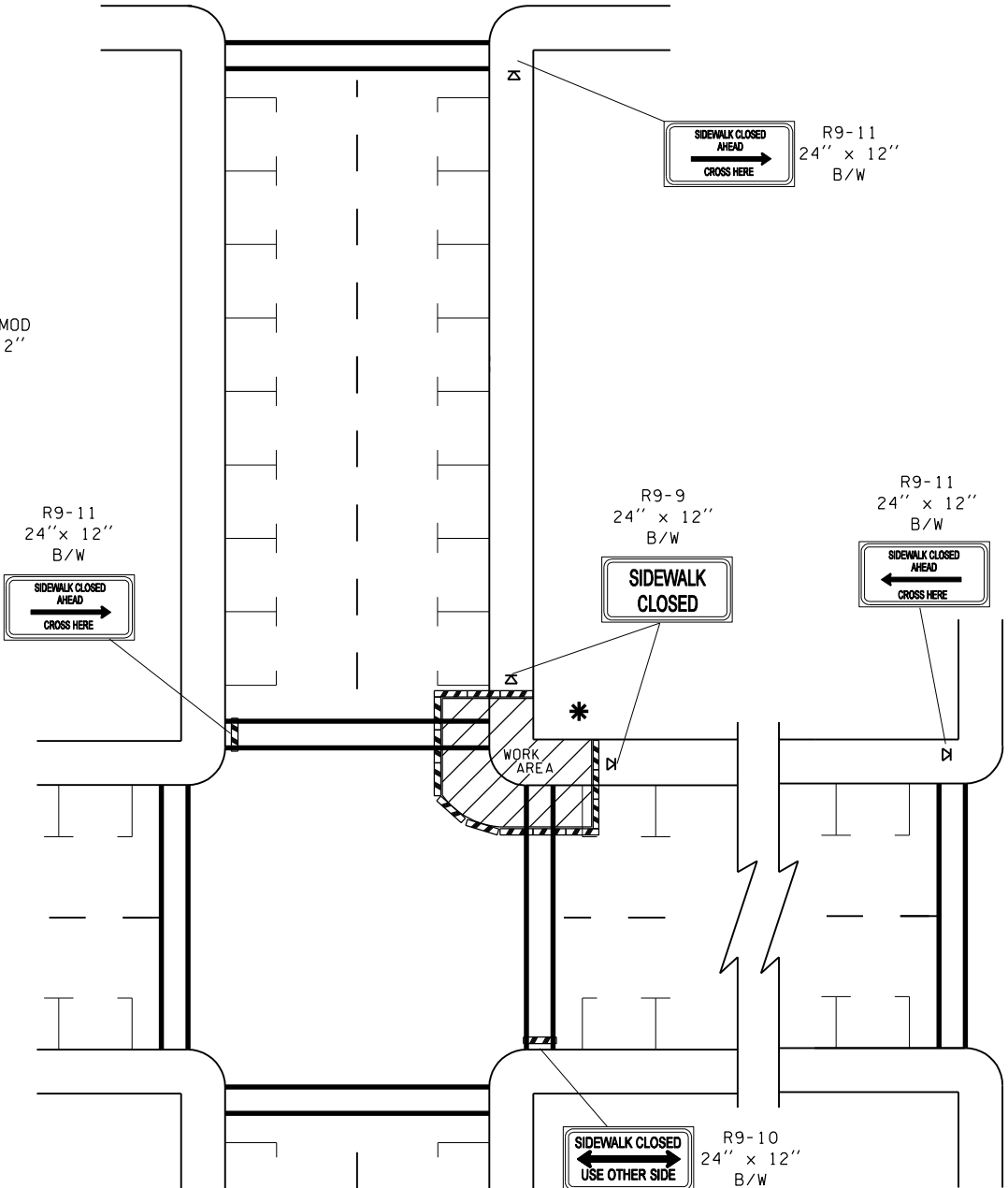

PEDESTRIAN DETOUR
(WORKING HOURS)

LEGEND

- ⊠ SIGN LOCATION
- ▣▣▣ CHANNELIZING DEVICES
- ▨ TYPE II BARRICADE

GENERAL NOTES

1. CONTROLS SHOWN ARE FOR PEDESTRIAN TRAFFIC ONLY.
2. USE WARNING LIGHTS ON BARRICADES.
3. MAINTAIN A MINIMUM WIDTH OF 36" FOR PEDESTRIAN PATH.
4. CONTACT AND COORDINATE IMPACTED TRANSIT AGENCIES PRIOR TO IMPLEMENTING ANY CLOSURES.

EMERGENCY OPERATIONS









Traffic Control Plan (TCP) 31

The immediate response to an emergency situation must, by necessity, make use of whatever devices and equipment are available. Assistance from the Washington State Patrol and WSDOT Incident Response Team may be appropriate. The use of flares is allowed unless flammable material is present, electronic flares are an option.

Implement the appropriate traffic control plan (lane closure, etc.) if the situation is expected to last longer than 60 minutes. This allows for a short duration operation, until traffic control assistance arrives.

Response to an emergency situation is inherently more dangerous than planned situations. Do not expose yourself to a life-threatening situation. Wait for assistance and protect yourself at all times.

INSTALL THESE OR OTHER WARNING SIGNS AS NEEDED FOR THE SPECIFIC HAZARD.

							
W20-4 48" x 48" B/O	W8-1501 48" x 48" B/Y	R11-4 5' x 30" B/W	R1-2 36" x 36" R/W	W8-1 48" x 48" B/O	W8-1801 48" x 48" B/O	W21-1701 48" x 48" B/O	W21-801 48" x 48" B/O

PCMS	
1	2
CAUTION STORM DEBRIS	ON ROAD NEXT XX MILES
1.5 SEC	1.5 SEC

FIELD LOCATE IN ADVANCE OF DEBRIS

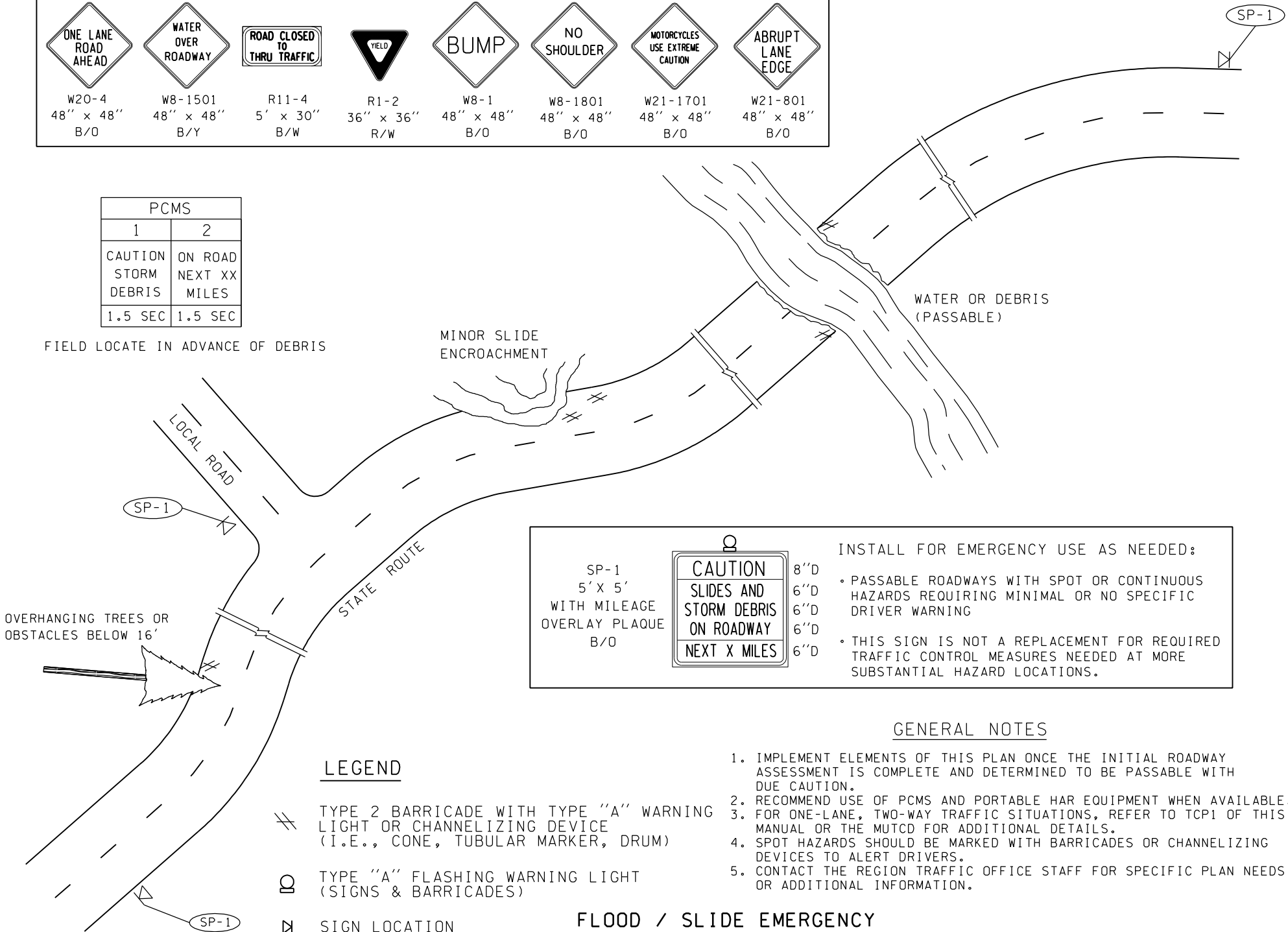

INSTALL FOR EMERGENCY USE AS NEEDED:



SP-1 5' X 5' WITH MILEAGE OVERLAY PLAQUE B/O		8"D 6"D 6"D 6"D 6"D
--	--	---------------------------------

- PASSABLE ROADWAYS WITH SPOT OR CONTINUOUS HAZARDS REQUIRING MINIMAL OR NO SPECIFIC DRIVER WARNING
- THIS SIGN IS NOT A REPLACEMENT FOR REQUIRED TRAFFIC CONTROL MEASURES NEEDED AT MORE SUBSTANTIAL HAZARD LOCATIONS.

GENERAL NOTES

- IMPLEMENT ELEMENTS OF THIS PLAN ONCE THE INITIAL ROADWAY ASSESSMENT IS COMPLETE AND DETERMINED TO BE PASSABLE WITH DUE CAUTION.
- RECOMMEND USE OF PCMS AND PORTABLE HAR EQUIPMENT WHEN AVAILABLE.
- FOR ONE-LANE, TWO-WAY TRAFFIC SITUATIONS, REFER TO TCP1 OF THIS MANUAL OR THE MUTCD FOR ADDITIONAL DETAILS.
- SPOT HAZARDS SHOULD BE MARKED WITH BARRICADES OR CHANNELIZING DEVICES TO ALERT DRIVERS.
- CONTACT THE REGION TRAFFIC OFFICE STAFF FOR SPECIFIC PLAN NEEDS OR ADDITIONAL INFORMATION.

LEGEND

-  TYPE 2 BARRICADE WITH TYPE "A" WARNING LIGHT OR CHANNELIZING DEVICE (I.E., CONE, TUBULAR MARKER, DRUM)
-  TYPE "A" FLASHING WARNING LIGHT (SIGNS & BARRICADES)
-  SIGN LOCATION

SPECIAL DETAILS AND TCP'S

Traffic Control Details (TCD's) 1 to 5

The following detail plans show the placement of signs, channelizing devices, and pavement markings, which are difficult to show on other traffic control plans or where additional guidance is necessary. A detail is also included as a guideline for signing a chip seal operation (TCD 4) and this includes an example reduced speed limit scenario. Be sure to include specific warning signs along with any reduction in the legal speed so the drivers have proper expectancy and know why they are being asked to slow down.

WARNING SIGNS

LOCATE AS NEEDED FOR SITE CONDITIONS
TO SUPPLEMENT WARNING SIGNS

W21-801
48" x 48"
B/O

W8-1801
48" x 48"
B/O

W21-1701
48" x 48"
B/O

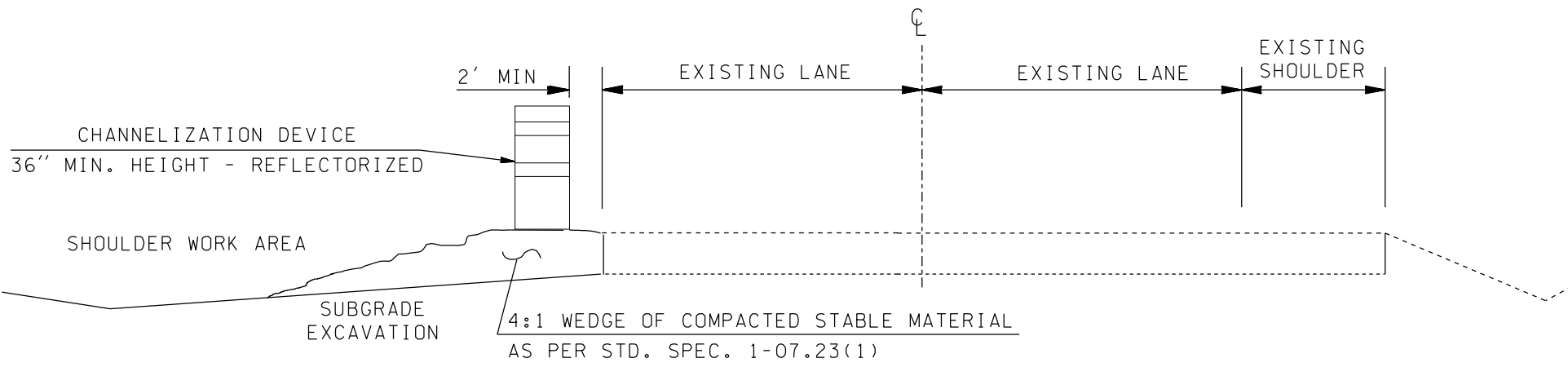

OPERATIONAL NOTES

1. SHOULDER EXCAVATION SHALL BE LIMITED TO ONE SIDE OF ROADWAY AT A TIME.
2. TYPE "C" STEADY BURN LIGHTS ARE RECOMMENDED ON CHANNELIZATION DEVICES TO PROVIDE ADDITIONAL DELINEATION.
3. REFER TO STD. SPEC. 1-07.23 FOR ADDITIONAL DETAILS ON THE MITIGATION REQUIREMENTS FOR DROP OFF PROTECTION.

SIGN SPACING = X (feet)		
Freeways & Expressways	55/70 MPH	1500'+- (OR AS PER MUTCD)
Rural Highways	60/65 MPH	1000'+-
Rural Roads	45/55 MPH	500'+-
Rural Roads & Urban Arterials	35/40 MPH	350'+-
Rural Roads, Urban Streets Residential & Business Districts	25/30 MPH	200'+-
Urban Streets	25 MPH or LESS	100'+-

ALL SIGNS ARE 48" x 48" BLACK ON ORANGE UNLESS OTHERWISE DESIGNATED.

All spacing may be adjusted to accommodate interchange ramps, at-grade intersections, and driveways.



W21-801



W8-1801



W8-1



W8-2001

FIELD LOCATE AS NEEDED THROUGH WORK AREA TO SUPPLEMENT
MOTORCYCLE WARNING SIGN. (1 MILE INCREMENTS)

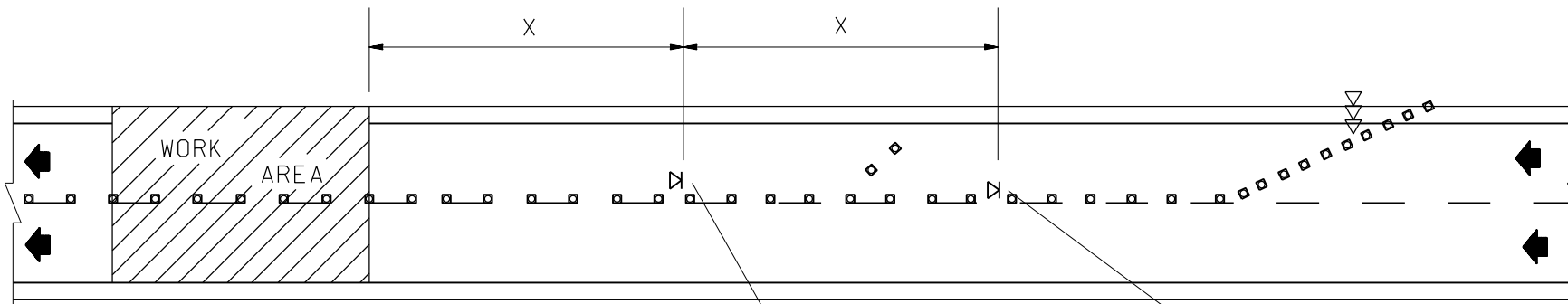

CHANNELIZING DEVICE SPACING (FEET)		
MPH	TAPER	TANGENT
50/70	40	80
35/45	30	60
25/30	20	40



W21-1701



W8-2001

NOTES

- REFER TO TCP3 FOR TYPICAL LANE CLOSURE SIGNING DETAILS, DEVICE SPACING REQUIREMENTS AND LANE CLOSURE TAPER LENGTHS.

LEGEND

- ▤ SIGN LOCATION
- ▤▤ SEQUENTIAL ARROW SIGN
- ▣▣▣ CHANNELIZING DEVICES

TYPICAL MOTORCYCLE SIGNING DETAIL
TCD 2

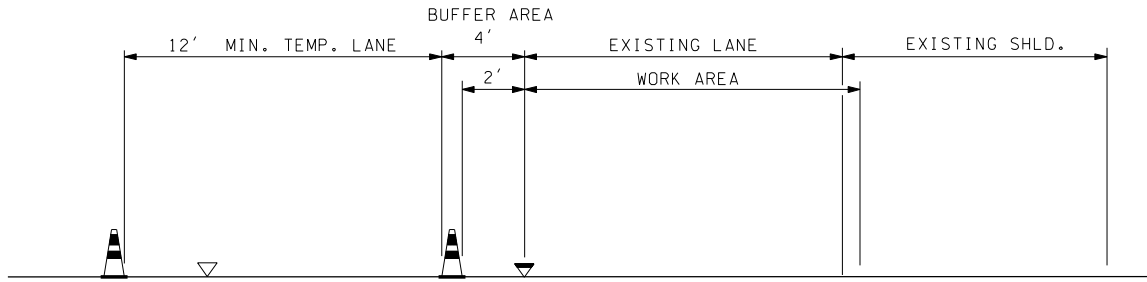

TYPICAL SECTION A-A

- TEMPORARY TRAFFIC CONTROL DEVICES
- EXISTING EDGE STRIPE
- EXISTING LANE STRIPE

CHANNELIZING DEVICE SPACING (FEET)		
MPH	TAPER	TANGENT
50/70	40	80
35/45	30	60
25/30	20	40

SIGN SPACING = X (feet)		
Freeways & Expressways	55/70 MPH	1500'+- (OR AS PER MUTCD)
Rural Highways	60/65 MPH	1000'+-
Rural Roads	45/55 MPH	500'+-
Rural Roads & Urban Arterials	35/40 MPH	350'+-
Rural Roads, Urban Streets Residential & Business Districts	25/30 MPH	200'+-
Urban Streets	25 MPH or LESS	100'+-

ALL SIGNS ARE 48" x 48" BLACK ON ORANGE UNLESS OTHERWISE DESIGNATED.
All spacing may be adjusted to accommodate interchange ramps, at-grade intersections, and driveways.

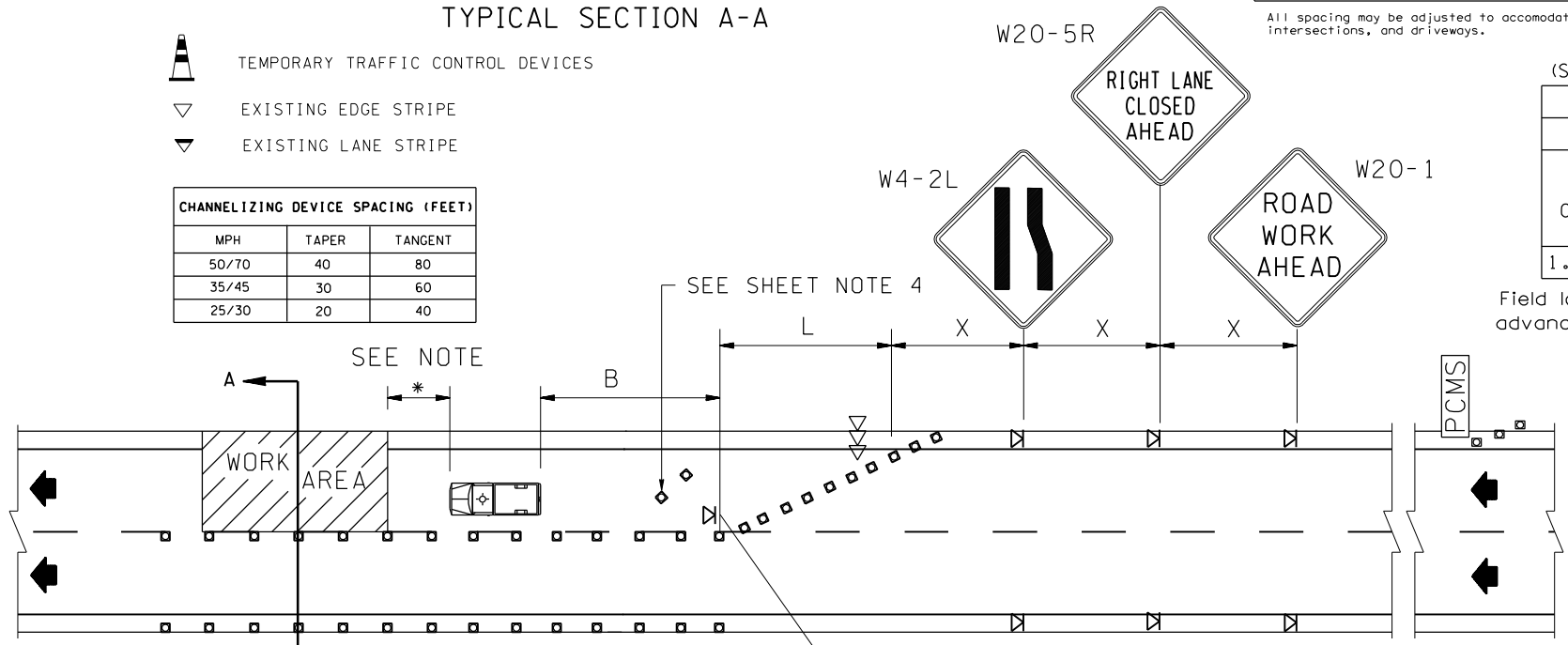

(SAMPLE MESSAGE)

PCMS	
1	2
LANE CLOSED	1 MILE AHEAD
1.5 SEC	1.5 SEC

Field locate 1 mile +- in advance of lane closure.

NOTES

1. PROTECTIVE VEHICLE RECOMMENDED-MAY BE A WORK VEHICLE.
2. CONTACT REGION TRAFFIC OFFICE FOR WORK HOUR RESTRICTIONS.
3. RECOMMEND EXTENDING DEVICE TAPER ACROSS SHOULDER. (L/3 TAPER)
4. USE TRANSVERSE DEVICES IN CLOSED LANE EVERY 1000'+- (RECOMMENDED).
5. TRAFFIC SAFETY DRUMS RECOMMENDED FOR ALL TAPERS ON HIGH SPEED ROADWAYS. (SEE DEVICE MATRIX)
6. PCMS RECOMMENDED.

LEGEND

- WARNING BEACON - REQUIRED
- SIGN LOCATION
- SEQUENTIAL ARROW SIGN
- CHANNELIZING DEVICES
- PROTECTIVE VEHICLE - RECOMMENDED
- PORTABLE CHANGEABLE MESSAGE SIGN

BUFFER DATA										
LONGITUDINAL BUFFER SPACE = B										
SPEED (MPH)	25	30	35	40	45	50	55	60	65	70
LENGTH (feet)	55	85	120	170	220	280	335	415	485	585
PROTECTIVE VEHICLE WITH TMA ROLL AHEAD DISTANCE										
TYPICAL PROTECTIVE VEHICLE TYPE WITH TMA	TYPICAL PROTECTIVE VEHICLE (WITH TMA) LOADED WEIGHT (LBS)									STATIONARY OPERATION (feet)
4 YARD DUMP TRUCK, SERVICE TRUCK, FLAT BED, ETC.	MINIMUM WEIGHT 15,000 LBS. (MAXIMUM WEIGHT SHALL BE IN ACCORDANCE WITH MANUFACTURER RECOMMENDATION)									30 MIN.
ROLL AHEAD STOPPING DISTANCE ASSUMES DRY PAVEMENT										
• A PROTECTIVE VEHICLE IS RECOMMENDED REGARDLESS IF A TMA IS AVAILABLE. IF NO TMA IS USED, THE PROTECTIVE VEHICLE SHALL BE STRATEGICALLY LOCATED IN THE FIELD TO SHIELD WORKERS AND NO ROLL AHEAD DISTANCE IS SPECIFIED.										

MINIMUM TAPER LENGTH = L (feet)										
LANE WIDTH (feet)	Posted Speed (mph)									
	25	30	35	40	45	50	55	60	65	70
10	105	150	205	270	450	500	550	-	-	-
11	115	165	225	295	495	550	605	660	-	-
12	125	180	245	320	540	600	660	720	780	840

TYPICAL LANE CLOSURE WITH SHIFT TCD 3

POSTED SPEED	DECELERATION LENGTH NEEDED TO REACH LISTED ADVISORY SPEED - MPH = D					
	10	20	30	40	50	60
70	525	500	425	350	250	150
65	425	400	350	175	N/A*	N/A*
60	350	300	250	175	N/A*	--
55	275	225	175	100	N/A*	--
50	200	150	100	N/A*	--	--
45	125	N/A*	N/A*	--	--	--
40	N/A*	N/A*	N/A*	--	--	--
35	N/A*	N/A*	N/A*	--	--	--
30	N/A*	N/A*	--	--	--	--
25	N/A*	--	--	--	--	--

* NO SUGGESTED MINIMUM DISTANCES ARE PROVIDED FOR THESE SPEEDS, AS THE PLACEMENT LOCATION IS DEPENDENT ON SITE CONDITIONS AND OTHER SIGNING TO PROVIDE AN ADEQUATE ADVANCE WARNING FOR THE DRIVER.

SIGN SPACING = X (feet)		
Freeways & Expressways	55/70 MPH	1500'+- (OR AS PER MUTCD)
Rural Highways	60/65 MPH	1000'+-
Rural Roads	45/55 MPH	500'+-
Rural Roads & Urban Arterials	35/40 MPH	350'+-
Rural Roads, Urban Streets Residential & Business Districts	25/30 MPH	200'+-
Urban Streets	25 MPH or LESS	100'+-

ALL SIGNS ARE 48" x 48" BLACK ON ORANGE UNLESS OTHERWISE DESIGNATED.

All spacing may be adjusted to accommodate interchange ramps, at-grade intersections, and driveways.

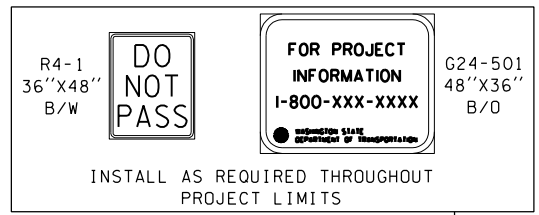
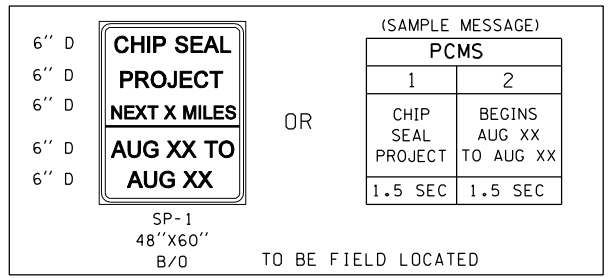

PLACE SIGN TO INDICATE LEGAL TO RESUME SPEED

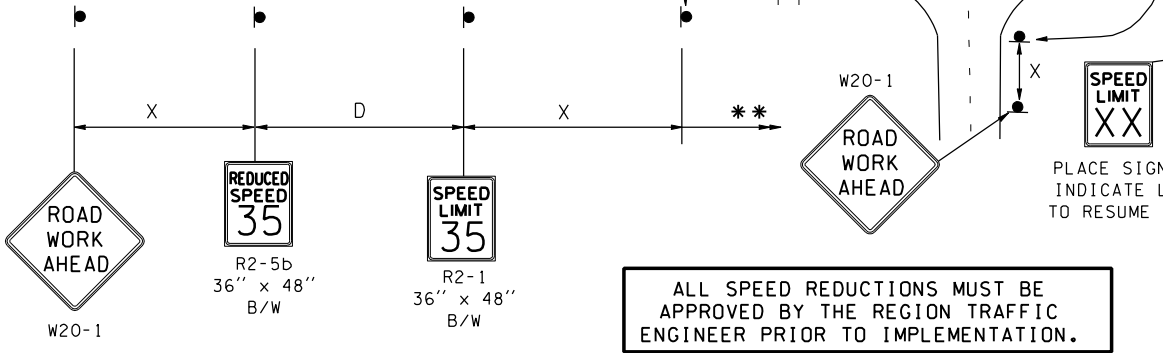
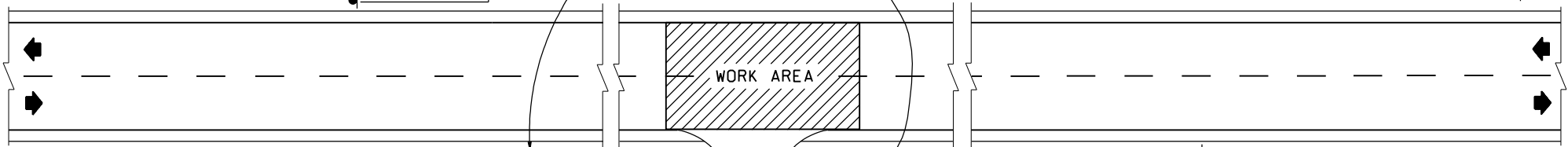
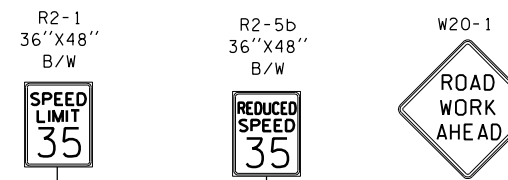
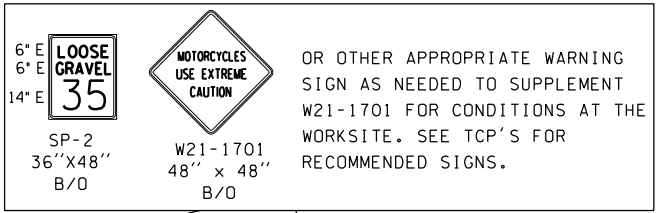

ALL SPEED REDUCTIONS MUST BE APPROVED BY THE REGION TRAFFIC ENGINEER PRIOR TO IMPLEMENTATION.

GENERAL NOTES

1. REFER TO LANE CLOSURE PLANS FOR LANE CLOSURE DETAILS AND SIGNING.
2. THE TABLES PROVIDED ARE AN AIDE FOR DETERMINING SIGN LOCATIONS. THE VALUES CONTAINED IN THE TABLES SHOULD BE CONSIDERED MINIMUMS AND APPLIED IN THE FIELD WITH RESPECT TO SITE CONDITIONS.
3. CONTACT THE REGION TRAFFIC ENGINEER FOR ADDITIONAL GUIDANCE IF NEEDED DUE TO UNUSUAL SITE CONDITIONS OR TRAFFIC CHARACTERISTICS
4. REGULATORY SPEED LIMIT SIGNING IS NOT A SUBSTITUTE FOR WORK ZONE SIGNING REQUIRED TO WARN MOTORISTS.
5. SPEED ZONE SIGNING SHALL ONLY REMAIN IN PLACE FOR AS LONG AS THE REDUCED SPEED CONDITION APPLIES.
6. CONTACT THE REGION TRAFFIC OFFICE FOR SPECIAL SIGN ORDERS, SPEED REDUCTION NOTICES, ETC.
7. SEE TCD1 FOR TEMPORARY PAVEMENT MARKING DETAILS.
8. MOTORCYCLE WARNING SIGNS ARE REQUIRED AS PER WAC 468-95-315.
9. SPEED LIMIT REDUCTION SHALL CONFORM TO RCW 47.48.020

** CONTINUE SIGNS AS NEEDED BASED ON REQUIRED ROADWAY CONDITION WARNING AS SHOWN ON THE APPROPRIATE TCP.

LEGEND

- SIGN LOCATION
- ▨ WORK AREA LIMITS

TYPICAL SPEEDZONE DETAIL
CHIP SEAL PROJECTS
TCD 4

WORK OPERATIONS THAT REMOVE OR OBSCURE EXISTING PAVEMENT MARKINGS MUST PROVIDE FOR TEMPORARY MARKINGS UNTIL THE PERMANENT MARKINGS ARE APPLIED. PERMANENT MARKINGS SHALL BE INSTALLED WITHIN 2 WEEKS. THE DETAILS BELOW SHOW VARIOUS COMMON APPLICATIONS. CONTACT THE REGION TRAFFIC OFFICE STAFF FOR ASSISTANCE WITH MORE COMPLEX SITUATIONS.

MULTI-LANE ROADWAYS

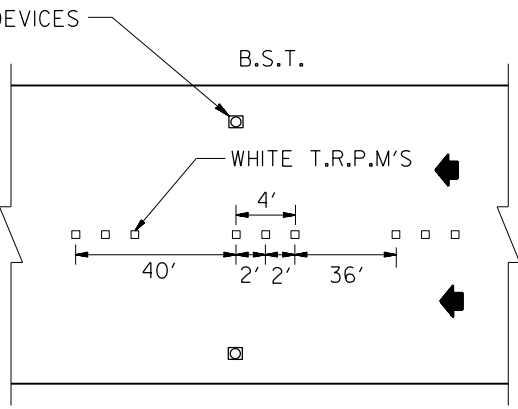
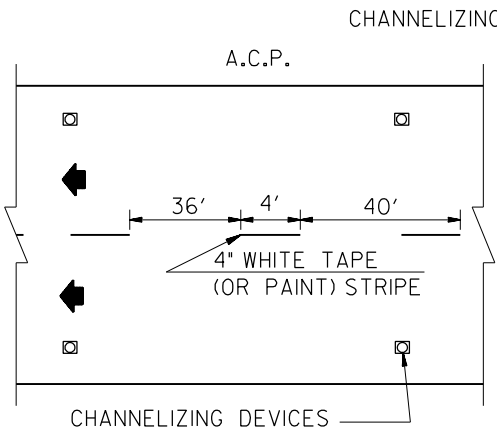
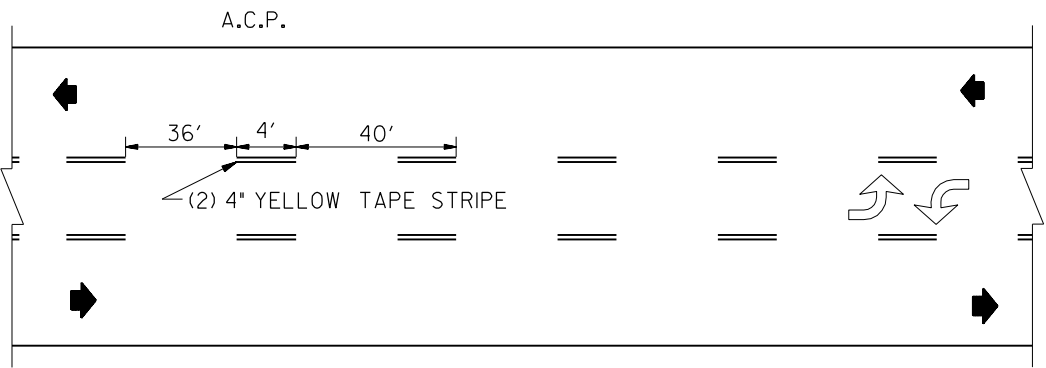

2 LANE ROADWAYS

A.C.P. OVERLAY - TEMPORARY STRIPING TAPE SHALL BE INSTALLED IN CONJUNCTION WITH "PASS WITH CARE" AND "DO NOT PASS" SIGN LOCATIONS.

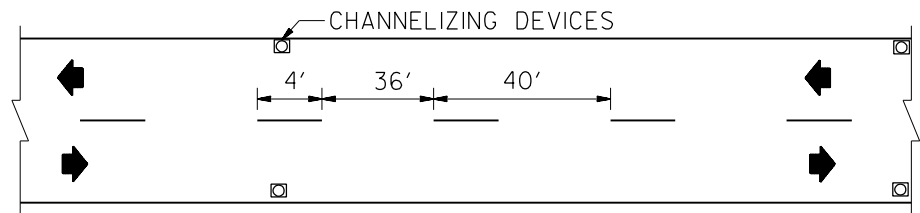

A.C.P. OVERLAY - TEMPORARY STRIPING TAPE - 4" YELLOW CENTER STRIPE

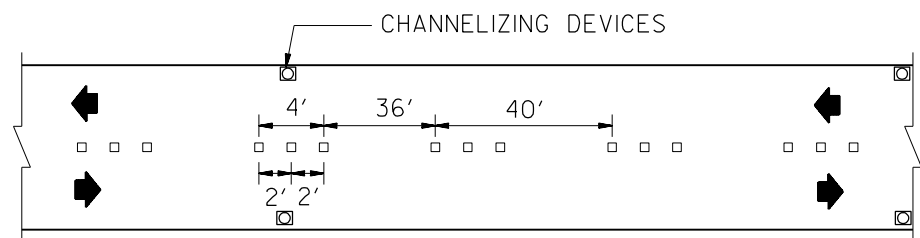

B.S.T. OVERLAY - T.R.P.M.(CHIP SEAL MARKER) - 4" YELLOW CENTER STRIPE

TEMPORARY EDGE STRIPES ARE NOT REQUIRED FOR THE ABOVE SITUATIONS BUT IF USED, T.R.P.M.'S MAY BE USED ON A PATTERN SPACING OF 5' O.C. TO SIMULATE A SOLID LINE. TEMPORARY ROADSIDE DELINEATION WITH CHANNELIZATION DEVICES SHOULD BE CONSIDERED, BUT ARE OPTIONAL. DO NOT USE A "SKIP" PATTERN OF TAPE STRIPE TO SIMULATE AN EDGE STRIPE. FOR LONG TERM PROJECTS, A TEMPORARY CHANNELIZATION/PAVEMENT MARKING PLAN SHOULD BE DEVELOPED.

CHANNELIZATION DEVICE SPACING - TANGENT 200' +-
 CURVES 100' +-
 TAPERS 1/2 L

T.R.P.M. = TEMPORARY RAISED PAVEMENT MARKER

**** The following bulletins have been updated to meet current standards where applicable.**

Appendix 1-1 *Flagger Safety***

- New rules memo
- Summary of rules
- Flagger Hazard Awareness Briefing

Appendix 2-2 *Work Zone Signs*

- Approved Type X sign sheeting examples

Appendix 3-3 *Traffic Control Plans***

Appendix 4-4 *Channelizing Device Application Matrix*

Appendix 5-5 *Worker Safety During Paving Operations*



FLAGGER SAFETY

Flagger safety is a top priority for WSDOT and much has happened in the past two years or so to improve flagger safety. This bulletin is intended to provide safety awareness and guidance on compliance to current standards. Those involved in flagging operations as a flagger, supervisor, crew member or manager need to be familiar with the requirements for work zone flagging operations. Flaggers tend to be more exposed to traffic and equipment hazards and the following guidance is intended to reduce exposure to those hazards.

Standards

The standards that apply to flagging operations are found in;

- Manual on Uniform Traffic Control Devices (MUTCD) Millennium Edition, Part 6

<http://www.wsdot.wa.gov/biz/trafficoperations/pdf/6andi.pdf>

- Work Zone Traffic Control Guidelines, M54-44

<http://www.wsdot.wa.gov/fasc/EngineeringPublications/Manuals/Workzone.pdf>

- Washington Administrative Code WAC 296-155-305

<http://www.leg.wa.gov/wac/index.cfm?fuseaction=Section&Section=296-155-305>

Knowledge and compliance to these standards is a necessary and important part of conducting safe flagging operations.

Guidance

The following guidance applies the above standards to WSDOT flagging operations and specifically addresses some of the hazards and practices.

- Use of flaggers should be limited as much as possible and only use flaggers when all other forms of traffic control are not appropriate or effective.
- Flagging from the center of an intersection (with or without a paddle) is not allowed. (law enforcement officers can direct traffic from the center of an intersection)
- Flagging on centerline of a roadway (surveying, inspection, pavement marking, etc.) without appropriate lane closure or lane shifting traffic control is not allowed.
- Unprotected flagging stations in close proximity to backing equipment is not allowed.
- Unprotected flagging stations in active traffic locations or work zones with activities such as hauling & loading, commercial access, multiple work activities & crews,

multiple traffic approaches or traffic approaching from behind the flagger are not allowed.

- Flagging stations with no escape route are not allowed unless positive protection is in place at the flagger station.
- Flagging at intersections where flagger direction and signal displays conflict are not allowed except for short duration work or emergencies. Signals should be turned off for longer duration flagging operations.
- Flagger stations must be illuminated at night.
- Flagger job site orientation is required prior to flagging. (see attached below “flagger hazard awareness briefing” and summary of rules)

The above listed issues are examples and not a complete list. All flagging operations must be evaluated for safety and standards compliance as part of a work planning process.

The following documents summarize WSDOT’s implementation of the flagging WAC’s.



newrulesmemo.doc summaryofrules.doc "ER trng card.doc"

Resources

Resources for alternatives to flagging traffic control are available through the Region Traffic Offices. Approved traffic control plans (TCP) are required for flagging, as with all work zones, and the flagging station must be incorporated into and be an integral part of the TCP. If the approved TCP’s in the M54-44 or other approved plans do not adequately address a specific work zone, the Region Traffic Office should be contacted to assist with developing an acceptable TCP. The Region and HQ Safety Offices are also a resource for flagging guidance.

Additional guidance for;

- Short duration flagging
- Mobile & moving flagging
- Emergency flagging

is being developed and will be made available in the future.

Also, new flagging devices and methods are being evaluated. Such as;

- Portable signal systems
- Automated flagging devices
- Intrusion alarms and other warning devices
- Protective devices

Summary

Generally WSDOT does a good job of flagging in a safe and effective manner, but there are hazards that need to be addressed and new rules to comply with. With so much at stake.....*your life, a co-worker and others*, please take the time to consider this bulletin.



July 19, 2001

TO: Jerry Lenzi
Don Senn
John Okamoto

Randy Hain
Leonard Pittman
Donald Wagner

THRU: Brian Ziegler

FROM: Toby Rickman

SUBJECT: Implementation of L&I's Permanent Flagging Rules

On March 1, 2001, the Department of Labor and Industries enacted permanent rules aimed at improving the safety of highway workers. The rules enact many safety requirements that our department has already adopted for WSDOT operations and WSDOT projects for several years. There are, however, a few new requirements which will need to be introduced into our operations. Also, the previously enacted emergency rules of June 1, 2000, have either been incorporated into the permanent rules or have been eliminated. Supervisors should ensure that current flagging practices are in compliance with the new permanent rules.

The attached document provides implementation guidance on five requirements of the rules that are either new to WSDOT or require clarification. The department's approach to the issue of providing flaggers with adequate warning of objects approaching from behind is the most challenging of the new requirements.

The ideal solution to flagger safety in general is to limit the use of flaggers as much as possible and only use flaggers when all other forms of traffic control are not appropriate or are ineffective. Realistically much of our work, especially on two lane highways necessitates the use of flaggers. Knowing this, we must strategically locate flagging stations to provide the best overall level of safety for the flagger while providing effective flagging direction. The attached document provides guidance on combining methods, locations, protection and devices as dictated by work zone conditions, to improve flagger safety and comply with the new rules.

This information should be discussed periodically during safety meetings and flagger job site orientations to maintain flagger safety awareness and alertness at the forefront.

Regional Administrators
July 19, 2001
Page 2

The attached information should receive wide dissemination to all organizations that use flaggers.

TR/FRN:frn
Attachment

cc: Doug MacDonald
Paula Hammond
Kevin Dayton
Ken Kirkland
Rex Swartz

SUMMARY OF NEW FLAGGER RULES

June 28, 2001

In accordance with new WAC safety standards effective March 1, 2001, the following summary addresses those changes that require action by WSDOT to achieve compliance. Several of the new safety standards were already part of WSDOT's standards and are now required for all flagging operations. This summary focuses only on those new standards that require a change to current WSDOT procedures and requirements or is in response to requests for clarification. Also, the previous emergency rules implemented June 1, 2000 are no longer in effect and have either been incorporated into the permanent rules or have been eliminated. Supervisors should ensure that current flagging practices are in compliance with the new permanent rules.

Contractors, utilities, developers and others conducting flagging operations must also comply with the new requirements. This does not mean that others outside of WSDOT will necessarily use the same compliance methods as WSDOT. WSDOT permits, plans, specifications and agreements may contain specific requirements for flagging operations that require compliance by others.

1) WAC 296-155-205 (4b) Head Protection

This section adds a new requirement for flaggers on asphalt paving operations to comply with the requirements of WAC 296-155-305. Current WSDOT standards comply with this section except for the new requirement for "a high visibility hard hat that is marked with 12 square inches of retroreflective material applied to provide 360 degrees of visibility". This requirement applies to all flagging operations during hours of darkness. A minimum of 3 square inches of retroreflective white or yellow tape, can be applied to each of the 4 hard hat sides to gain compliance.

2) WAC 296-155-305 Signaling and Flaggers

Section (8)

This section adds the requirement that if flaggers cannot be positioned so they are not exposed to traffic or equipment approaching from behind, then flaggers must have adequate warning of these types of hazards approaching them from behind.

WSDOT will address this requirement by only using flaggers when all other means of traffic control is not appropriate or effective. When flaggers are used, flagging stations will be strategically located to provide the best overall level of safety for the flagger, while providing effective flagging direction to traffic. Also, increased flagger awareness and alertness, using flagging procedures that minimize or eliminate the time a flagger has their back to traffic and by using spotters when backing WSDOT vehicles with restricted rear vision near a flagger will be used. A flagger awareness briefing will be conducted and incorporated into safety meetings, field "tool box" safety talks, etc. The attached "Flagger Hazard Awareness Briefing" message shall be read and discussed at the above mentioned safety meetings.

Some specific examples of devices and methods for protecting or warning flaggers from behind are:

- Concrete or water filled barriers
- Buffer vehicles
- Spotter (spotters should only be used when all other types of warning are not effective and any hazard to the spotter is exceeded by the hazards to an exposed flagger and/or work crew) a protected location for the spotter should be used when possible.
- Motion detectors with audible warning
- Larger or more “imposing” channelization devices or barricades placed to delineate the area around the flagging station. Also, more channelization devices on reduced spacing should be considered.
- Rumble strips that produce an audible warning.

A mirror attached to the flag paddle staff or the flaggers hard hat has been suggested, but is not recommended as an effective device by itself and could possibly be distracting. Also, standard equipment backup alarms which are already required on construction equipment do not comply with this requirement.

WSDOT believes that constant reminders of the need to safeguard flaggers from hazards through increased on-site awareness emphasis, strategic flagger station locations, improved flagging methods and use of protective devices, either individually or combined as dictated by the work zone and traffic conditions will improve flagger safety and comply with the new rule.

Section (9a)

This section requires that the flagger(s) receive an orientation that initially familiarizes the flagger with the job site and again when job site conditions or work operations change significantly. The orientation must include but is not limited to:

- The flagger’s role and location on the job site
- Motor vehicles and equipment in operation on the site
- Job site traffic patterns
- Communication and signals to be used between flaggers, equipment operators and workers
- On-foot escape route
- Other hazards specific to the job site
- Compliance and adjustments to the traffic control plan that identifies the flagger stations

The intent of this rule is to incorporate the flagger(s) into the work zone operations and to ensure that all involved are aware of and comply with the operational procedures. Supervisors are responsible to document the details of the orientation.

Section (10)

This section defines the requirements for warning signs used for flagging operations. WSDOT currently complies with these requirements except for the following situation.

A 4 sign sequence is required for flagging on roadways with posted speeds of 45 MPH or higher. WSDOT's standard 4 sign sequence for "one lane road" situations is in compliance. However, there are situations other than "one lane road" where the 4 sign sequence is still required. These situations could be truck crossings, bridge work, surveying, etc. where flaggers are required to stop traffic for a short period of time. In these cases the most appropriate standard warning sign that reflects the roadway condition or work operation should be used in place of the "one lane road ahead" sign to comply with the 4 sign sequence requirement. These signs might be;

- Truck crossing
- Road machinery
- Utility work
- Survey crew
- Blasting
- Workers, this sign could be a very generic yet appropriate solution in many cases

If the above signs are not available or appropriate for the operation, an acceptable alternative would be to repeat the "Flagger Ahead" sign or the "Be Prepared to Stop" sign. Again, the preferred method is to use the sign that most appropriately describes the roadway condition or work operation.

Section (11a)

This section requires illumination of flagging stations during hours of darkness, which is also a WSDOT standard. Contained within this section is an exemption from this illumination requirement for emergency situations. For purposes of this rule, "emergency" means an unforeseen occurrence endangering life, limb, or property. WSDOT further defines emergency operations in the Traffic Control Guidelines Book.

WSDOT currently does a good job of flagging traffic control. The fact that many of our flagging standards were incorporated into the new rules shows that we have been leaders in flagger safety. With so much at stake.....***the lives of our co-workers, contractors and other flaggers***, we must continue to raise awareness and implement effective procedures to protect them. Adding the above elements into our current procedures will provide an additional safety benefit.

The actual text of the WAC's can be found on line at the following link.

<http://www.lni.wa.gov/wisha/regs/WAC296-155-305Flagger.htm>

Many of the requirements of WAC 296-155-305 are referred to as "performance-based". This is intended to allow more than one solution while maintaining the intent of the rule and while addressing the specific type of work zone and hazards involved. Examples of non-mandatory suggestions to comply with requirements are provided and may be appropriate. Contact the Region Traffic Office or Operations Office for assistance with flagger safety issues or compliance with the new rules. The Traffic Control Guidelines Book, M54-44 will be updated to reflect these new requirements.

Flagger Hazard Awareness Briefing

Washington State work zone accident statistics show that flaggers are at greatest risk of being struck by traffic moving through a highway work zone. Flaggers also have risk of being struck by workzone vehicles and equipment while maintaining attention on traffic.

This calls for flaggers not only maintaining attention on moving traffic through the work zone safely, but also developing job skills and methods to maintain awareness of operations going on near their flagger station.

The following rules of conduct are key in developing job skills and methods to provide warning from objects approaching from the flaggers blind side.

- 1) Always be clearly visible to approaching traffic.
- 2) Always be aware of oncoming traffic.
- 3) Do not step into, or turn your back on, the traffic.
- 4) Stand on the shoulder of the road (toes facing the centerline) observing traffic and the work zone. Sometimes you may have to stand on the opposite side of the road to effectively direct traffic around the work area.
- 5) Stand alone.* Do not permit a group of workers to congregate around you.
- 6) Know your flagger station position and familiarize yourself with the nature of the work being performed.
- 7) Plan an escape route in the case of an emergency.
- 8) Stay alert. Be ready to respond to an emergency.
- 9) Keep your mind on your job. Be aware of the work in progress.
- 10) Position yourself to maintain focus on traffic and any work vehicles working near the flagger station.
- 11) Adjust your flagger station position as needed to increase your safety distance from work vehicles, while maintaining safe efficient movement of traffic through the work zone.

* Use of a spotter should be considered in certain, site specific, operations.

Please read and discuss this information at the flagger's job site orientation, any time the site conditions substantially change, and at least twice monthly. Supervisors must document who received this information and the date that they received it.

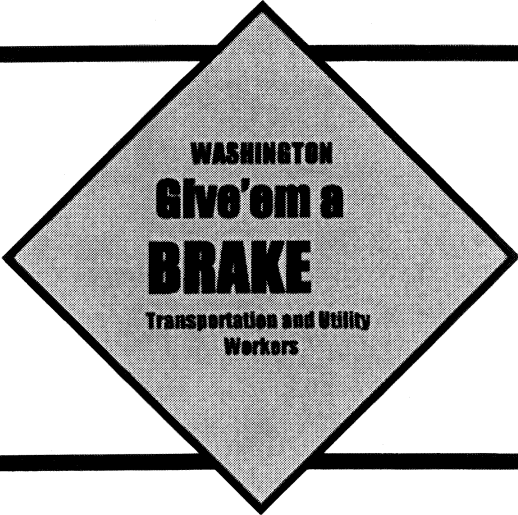

WASHINGTON
**Give 'em a
BRAKE**
Transportation and Utility
Workers

Work Zone Safety Bulletin

WORK ZONE SIGNS

October 2001

Background & Process

The Work Zone Safety Task Force completed its review and discussion on the use of 36" signs vs. 48" signs in work zones. The Task Force felt it was necessary to resolve this issue establishing clear guidelines for using 48" signs in work zones, thus eliminating inconsistent uses statewide. The Task Force agreed that 48" signs should be the WSDOT standard. This also fits well with our current direction to increase the visibility and conspicuity of our work zone signs by using the new fluorescent orange sign sheeting material.

The Headquarters Maintenance Office conducted a statewide survey to determine the sizes of signs currently used in work zones. Their survey indicated a mixture of the two sign sizes still being used across the state. Feedback from those surveyed, plus input from the maintenance and operations members of the Task Force identified the following issues:

- 48" signs can be more difficult to place in narrow or no shoulder locations, but it can be done.
- New portable sign stands may be needed in some cases to allow 48" sign placement.
- Many of the new NCHRP 350 approved sign stands have adjustable "all terrain" bases and legs.
- 48" signs may require more ballast than 36" signs used in windy areas.
- Current use of 36" signs may be due to long standing procedures that inadvertently were not updated or used by specialized crews that felt the smaller signs were needed due to site conditions.
- Also, the 48" standard may not have been consistently communicated across the state.

Standards

Current state and federal standards were reviewed to determine the correct standard. In this case the standards of the MUTCD apply, specifically part VI, 6F-1(2) paragraphs 4 and 5 as follows:

Where any part of the roadway is obstructed or closed, advance warning signs are required to alert traffic well in advance of these obstructions or restrictions. These signs may be used singly or in combination. Because of their importance, they shall have a standard size of 48 inches square and shall be the standard diamond shape for warning signs, except as provided above (standard sizes & allowance for larger signs). Signs larger than 48 inches square may be used for additional emphasis of the temporary traffic control zone.

Where speeds and volumes are moderately low, a minimum size of 36 inches square may be used for advance warning signs, if they have a minimum letter size of 5 inches.

Use of 36" signs would have to meet the "low speed and volume" criteria stated in paragraph 5 of the MUTCD. Although not specifically indicated, low speed is generally 40 mph or less. Low volume is a relative term, but for application to state routes 2000 ADT could be considered the upper limit. The "Millennium Edition" of the MUTCD (MUTCD 2000) maintains the same standard as the current MUTCD and references the 48" signs as a **standard** condition, which is the new terminology equivalent of the *shall* condition. The Work Zone Traffic Control Guidelines Book, M54-44 also refers to "standard" as being 48" x 48" signs".

Implementation

Work crews need to be aware of this standard and action should be initiated to replace existing 36" (or smaller) signs with 48" signs as needed. Even though the use of 48" signs have been the MUTCD standard for some time (since 1978) a reasonable timeframe to determine the need for new signs and reach full implementation is needed as follows:

- Determine the number and type of signs that need to be replaced with 48" signs
- Determine any additional equipment needed to accommodate the new 48" signs; NCHRP 350 compliant sign stands, shop or work vehicle storage & transporting equipment, additional sand bag ballast, etc.
- New signs should be fabricated with fluorescent orange sheeting
- Full implementation should be accomplished by the end of the current biennium
- Deviations may be allowed on a case by case basis to use 36" signs instead of 48" Signs based on actual conflicts that are justified and documented. Deviations will not be allowed for convenience or continuation of existing procedures.

This requirement applies to all work zones, including construction projects, utility work, survey crews, developers and others. We realize construction projects are generally covered by specifications and plans. Other work zones may require further oversight to ensure compliance with this requirement.

Reaching compliance with the 48" sign standard will require additional effort as the larger signs are integrated into our already established procedures. Compliance is required, but we also need to recognize the benefits gained in reduced liability risk and improved safety.

Contact Frank Newboles, State Work Zone and Safety Manager, by e-mail or at (360) 705-7392 for any questions.

APPROVED FLUORESCENT ORANGE SIGN SHEETING TYPE X

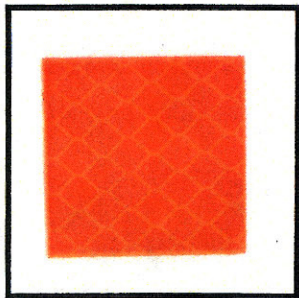

**3M – Scotchlite “Diamond Grade”
3924, (Formerly Type VII)**

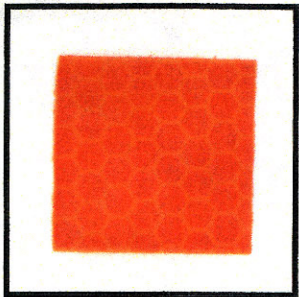

**Avery Dennison – “Super High
Performance” W-7514, (Formerly
Type IV)**

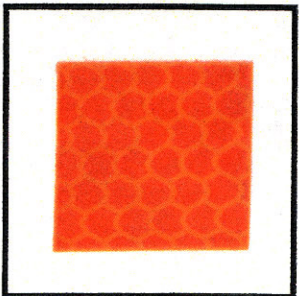

**Nippon Carbide – Nikkalite
“Crystal Grade” Series 94047,
(Formerly Type IV)**

WORK ZONE SAFETY BULLETIN

WORK ZONE SAFETY TASK FORCE

April 5, 2002

TRAFFIC CONTROL PLANS (TCP's)

TCP's are a required and necessary component of most work zones and may be the single most important tool for safe and effective traffic control operations when used appropriately. The following information explains the requirements for use of TCP's.

The following requirements are the *minimum allowed*. Supervisors must consider all work zone conditions and determine if additional traffic control and protective measures are needed. A TCP that accurately depicts the work zone and traffic control measures needed to safely provide for all traffic movements, traffic mobility and worker safety must be selected and implemented. The requirements for the following types of work zones provide the basic compliance level for most operations.

- Work zones (including all workers, materials and equipment) that are;
 - Behind approved traffic barriers
 - More than 2 feet behind a curb
 - 15 feet or more from the roadway shoulder

May not need traffic control devices or a TCP, if approved by the crew supervisor.

This is the only type of work zone that does not require advance warning to drivers.

All other work zones require advance warning as appropriate; hazard beacon, signs, etc.

- Intermittent work operations that use short stops of up to 15 minutes that are;
 - At low volume locations, or
 - At low speed locations, or (40 MPH or less)
 - On the roadway shoulder

May not need traffic control devices, (other than the work vehicle warning beacon) or

TCP if approved by the crew supervisor. 60 minutes is the maximum time limit

allowed if several intermittent work operations and locations are conducted within a 1-mile area. (See short duration or stationary work operation requirements.)

- Short Duration work operations lasting up to 60 minutes that are;
 - At low volume locations, or
 - At low speed locations, or (40 MPH or less)
 - On the roadway shoulder

May use simplified traffic control procedures, but still require an approved TCP.

- Long Term work operations lasting over 1 hour all require TCP's.
- Mobile work operations that generally move continuously at low speeds may require specialized TCP's to address the operations specific needs. The supervisor must ensure that an approved TCP is utilized.
- Operations that use flaggers must incorporate the flagger station and all other flagging requirements into the work operation. More than one TCP may be used if appropriate.

- Emergency response traffic control requirements allow the use of the best available devices for the first hour. Emergency response that lasts for more than an hour should implement appropriate traffic control measures in coordination with the on site emergency services authority. (see the Traffic Control Guidelines Book M54-44)
- Special work operations, such as;
 - Survey Crews
 - Roadway Testing Crews
 - Inspection
 - Traffic Data Collection

Are all required to use an approved TCP that conforms to the above listed requirements. Supervisors of these crews must ensure that appropriate TCP's are used.
- Work zone conditions are just as important as using the correct TCP and must be considered when selecting the TCP and planning for the work operation. Conditions such as;
 - High volume traffic hours
 - Weather conditions
 - Pedestrians and Bikes

Resources for TCP's, development and approval are available through;

- Traffic Control Guidelines Book, M54-44
- MUTCD Part VI
- Region Traffic Office

TCP's provide a focus point for supervisors and crews to plan ahead for the needed equipment, address work zone safety and traffic conditions and get all crew members on the same page. The TCP is also a reminder of what standards are involved and is your best evidence of compliance to those standards.

Remember, TCP's do not necessarily have to be complex or require lots of development time for every operation. Basic operations may be able to use the preapproved TCP's from the Traffic Control Guidelines Book (or slightly modified version) or other TCP's based on the MUTCD Part VI typical application diagrams. Original, specific, highly modified or complex TCP's should be developed in coordination with and approved by the Region Traffic Office.

The following excuses for not using or complying with the above TCP requirements are not acceptable and won't save you from an L&I citation, Law Enforcement citation, lawsuit, department corrective action, or worse yet a death or injury resulting from a work zone crash.

- "we've always done it this way"
- "we didn't have enough cones"
- "we didn't have the right signs"
- "we've never had a problem before"

Supervisors and Crew Members, consider this bulletin as a reminder to take the opportunity to review your work operations and ensure that the correct TCP's are in use. Many work zone operations take place in a harsh and unforgiving environment. The very nature of our work presents hazards that we all must recognize and take proper action to minimize the potential for an incident.

CHANNELIZING DEVICE APPLICATION MATRIX

Device Type	Low Speed (40 mph or less)	High Speed (45 mph or greater)
Cones -Tangent	✓	✓
Cones -Taper	✓	A*
Tall Channelizing Devices - Tangent	✓	✓
Tall Channelizing Devices - Taper	✓	✓*
Drums - Tangent	✓	✓
Drums - Taper	✓	R
Tubular Markers	✓	X*

A - Allowed, consider using a more visible device R - Recommended device

✓ - May be used in this situation X - Requires approval by Region Traffic Engineer

* - Double the amount of devices in taper, use DOUBLE SPACING column shown below (20')

CHANNELIZING DEVICE SPACING CHART (FEET)			
MPH	*DOUBLE SPACING*	TAPER	TANGENT
45/70	20	40	80
35/40	N/A	30	60
20/30	N/A	20	40

Design of Channelization Devices (see MUTCD Part VI and appropriate sections of this manual for additional guidance)

- All channelizing devices must comply with the requirements of the MUTCD and the NCHRP 350 traffic control device crash performance requirements.
- Cones – Freeway, high speed and night use requires 28” minimum height cones with 2 white retroreflective bands. Low speed daytime use allows 18” cones without retroreflective bands.
- Tall Channelizing Devices – 42” in height, minimum, using a tapered cone type shape of consistent dimensions regardless of orientation to traffic. A minimum of 2 white and 2 orange retroreflective horizontal stripes 6 inches wide. Designs that provide for secure mounting of a warning light are allowed.
- Drums – 36” in height and at least 18” wide of consistent dimensions regardless of orientation to traffic. A minimum of 2 white and 2 orange retroreflective horizontal stripes 4 to 6 inches wide. Designs that provide for secure mounting of a warning light are allowed.
- Tubular markers- Tubular markers should only be used where space restrictions do not allow for the use of other more visible devices or where specific conditions such as high wind may require a device that can be glued in place. Tubular markers may be used to divide opposing traffic lanes, divide open lanes in the same direction and to delineate the edge of a pavement drop off. A 2” minimum width is required. Freeway, high speed and night use requires a 28” minimum height with 2 white retroreflective bands. Low speed daytime use allows 18” tubular markers with 1 retroreflective band.

Known suppliers of tall channelizing devices: (others may be available)

Traffix Devices <http://www.traffixdevices.com/>

3D Traffic Works <http://www.trafficwks.com/product/twprod.html>

Bent Manufacturing <http://www.bentmfg.com/>

PSS <http://www.plasticsafety.com/nav.asp>



Date: June 1, 2004
TO: Regional Construction Engineers
THRU: Kevin Dayton
FROM: Rex Swartz *RSW*
SUBJECT: Statewide Initiative on Worker Safety During Paving Operations

The safety of those who work, drive, walk, and pedal in roadway work zones is of the highest priority. A well-planned and implemented work zone must safely provide for all users. In many cases, workers are exposed to the hazards involved with the actual work operation as well as moving traffic. Given this level of exposure to hazards, careful consideration must be given to effective methods of worker protection or hazard elimination.

Work zone safety for WSDOT inspection crews is a constant concern that deserves particular attention when we recognize an opportunity to make the work zone safer. One such opportunity is the safety of the asphalt density testers and others who follow the paving train during our paving operations. Our testers typically work alone, with minimal visibility and protection from traffic.

Paving Operations - Paving operations are very dynamic in that there is constant movement of equipment and workers, sometimes involved in many different activities. These operations can also become elongated as the work progresses. The advance work of layout and tacking followed by paving, rolling and testing can create a quite lengthy work area. In many cases, there is not sufficient lateral space to position a protective vehicle, and it is quite likely that one protective vehicle will not be sufficient to protect all the workers. Consideration must be given to the individual work and inspection activities and how safety might be improved by coordinating these activities with the best time and location. An example might be to conduct density testing when the pavement is cool enough to position a protective vehicle.

Consideration must be given to using work zone techniques that will improve safety for our testers, especially now as we continue to increase the amount of work we do at nighttime. As a minimum, all personnel must be aware of, and practice smart work zone habits, such as:

- During nighttime operations, always wear the proper nighttime safety apparel, including high visibility vest and pants (class III ensemble), hardhat with reflective tape and high visibility rain gear when necessary. All safety apparel must be maintained in a like-new condition.
- Be clearly visible to approaching traffic at all times. Motorists should be able to see you from a minimum of 390 meters (1,280 feet) away.
- Always be aware of oncoming traffic.
- Do not step into, or turn your back to traffic.

In addition, we need to consider how to best equip and position work vehicles and other devices to provide added protection.

Work Vehicle – All work vehicles must be equipped with an approved and operational flashing beacon and further, vehicles dedicated to work zone use may be equipped with full light bars to improve conspicuity. Work activities need to take place in close proximity to the work vehicle where feasible, since worker safety can be jeopardized if motorists' attention is focused on the work vehicle and beacon and the worker is at an unexpected location. The vehicle should be parked while in gear with the parking brake set and the front wheels turned away from the work area such that the after-impact trajectory is toward a safe area. The vehicle should be positioned to shield the worker from approaching traffic, if possible.

TMA Vehicle – The use of a Truck-Mounted Attenuator (TMA) is recommended in high-speed, multi-lane roadway work zones. The TMA is to be used in conjunction with the work vehicle. The TMA must be positioned a sufficient distance in front of the work area being protected to allow for appropriate vehicle roll-ahead after impact, but not so far that an errant vehicle will travel around the TMA and enter the work area, where feasible. Paving projects should consider including contractor-furnished and -operated TMAs on the project.

Supplemental Devices - Strategic use of work zone devices can help delineate the work area and provide additional advance warning to workers if an errant vehicle encroaches into the work area:

- **Lighting** - providing better lighting for the work area by use of portable light devices or enhanced vehicle-mounted lighting can be used to make our testers more visible to motorists. Care must be taken when using these light plants to ensure the glare to oncoming motorists is minimized.
- **Barrel Array** - placing a taper of channelizing devices in the closed lane in advance of the work area and work vehicle can provide a measure of added protection.
- **New Technology** - keeping an open mind to new or innovative approaches to work zone safety, is important and encouraged. The Region Traffic office is available to discuss and help coordinate use of such devices.

Remember, even though this testing takes only a short time, it is still a short duration work zone and the following requirements need to be addressed:

- Work should be done only in a lane closed to traffic,
- Channelizing devices should be considered to separate the work area from traffic, and
- Isolated locations require advanced warning to drivers, such as warning lights or signs.

As you move into this year's paving season, please plan ahead and make appropriate changes to your work operations. Please work with the Traffic Office when making revisions to your work zone configuration.

RWS:mce

M 22-24

Highway Engineering
Field Formulas



Metric (SI) or US Units

Unless otherwise stated the formulas shown in this manual can be used with any units. The user is cautioned not to mix units within a formula. Convert all variables to one unit system prior to using these formulas.

Significant Digits

Final answers from computations should be rounded off to the number of decimal places justified by the data. The answer can be no more accurate than the least accurate number in the data. Of course, rounding should be done on final calculations only. It should not be done on interim results.

Persons with disabilities may request this information be prepared in alternate forms by calling collect (360) 664-9009. Deaf and hearing impaired people call 1-800-833-6388 (TTY Relay Service).

1998
Engineering Publications
Transportation Building
Olympia, WA 98504
360-705-7430

CONTENTS

Nomenclature for Circular Curves	2
Circular Curve Equations	4
Simple Circular Curve	5
Degrees of Curvature to Various Radii	6
Nomenclature for Vertical Curves	7
Vertical Curve Equations	8
Nomenclature for Nonsymmetrical Curves	10
Nonsymmetrical Vertical Curve Equations	11
Determining Radii of Sharp Curves	12
Dist. from Fin. Shld. to Subgrade Shld.	13
Areas of Plane Figures	14
Surfaces and Volumes of Solids	18
Trigonometric Functions for all Quadrants	23
Trigonometric Functions	24
Right Triangle	25
Oblique Triangle	26
Conversion Factors	28
Metric Conversion Factors	30
Land Surveying Conversion Table	31
Steel Tape Temperature Corrections	31
Temperature Conversion	31
Less Common Conversion Factors	32
Water Constants	32
Cement Constants	32
Multiplication Factor Table	33
Recommended Pronunciations	33
Reinforcing Steel	34

Nomenclature For Circular Curves

POT	Point On Tangent outside the effect of any curve
POC	Point On a circular Curve
POST	Point On a Semi-Tangent (within the limits of a curve)
PI	Point of Intersection of a back tangent and forward tangent
PC	Point of Curvature - Point of change from back tangent to circular curve
PT	Point of Tangency - Point of change from circular curve to forward tangent
PCC	Point of Compound Curvature - Point common to two curves in the same direction with different radii
PRC	Point of Reverse Curve - Point common to two curves in opposite directions and with the same or different radii
L	Total Length of any circular curve measured along its arc
L_c	Length between any two points on a circular curve
R	Radius of a circular curve
Δ	Total intersection (or central) angle between back and forward tangents

Nomenclature For Circular Curves (Cont.)

DC	Deflection angle for full circular curve measured from tangent at PC or PT
dc	Deflection angle required from tangent to a circular curve to any other point on a circular curve
C	Total Chord length, or long chord, for a circular curve
C'	Chord length between any two points on a circular curve
T	Distance along semi-Tangent from the point of intersection of the back and forward tangents to the origin of curvature (From the PI to the PC or PT)
tx	Distance along semi-tangent from the PC (or PT) to the perpendicular offset to any point on a circular curve. (Abscissa of any point on a circular curve referred to the beginning of curvature as origin and semi-tangent as axis)
ty	The perpendicular offset, or ordinate, from the semi-tangent to a point on a circular curve
E	External distance (radial distance) from PI to midpoint on a simple circular curve

Circular Curve Equations

Equations	Units
$R = \frac{180^\circ}{p} \times \frac{L}{D}$	m or ft.
$D = \frac{180^\circ}{p} \times \frac{L}{R}$	degree
$L = \frac{p}{180} \times RD$	m or ft.
$T = R \tan \frac{D}{2}$	m or ft.
$E = \frac{R}{\cos \frac{D}{2}} - R$	m or ft.
$C = 2R \sin \frac{D}{2}, \text{ or } = 2R \sin DC$	m or ft.
$MO = R \frac{a}{e} \left[1 - \cos \frac{D \ddot{\theta}}{2 \dot{\theta}} \right]$	m or ft.
$DC = \frac{D}{2}$	degree
$dc = \frac{L_c}{L} \frac{a}{e} \frac{D \ddot{\theta}}{2 \dot{\theta}}$	degree
$C' = 2R \sin(dc)$	m or ft.
$C = 2R \sin(DC)$	m or ft.
$tx = R \sin(2dc)$	m or ft.
$ty = R[1 - \cos(2dc)]$	m or ft.

Degree of Curvature for Various Lengths of Radii

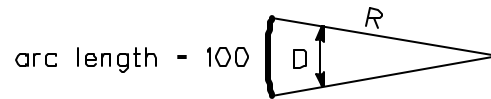

Exact for Arc Definition

$$D = \frac{100 \frac{\pi}{180} \frac{180}{\theta}}{R} = \frac{18000}{pR}$$

Where D is Degree of Curvature

Length of Radii for Various Degrees of Curvature

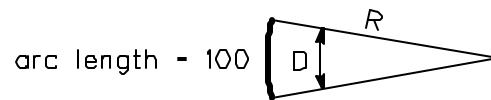

$$R = \frac{100 \frac{\pi}{180} \frac{180}{\theta}}{D} = \frac{18000}{pD}$$

Where R is Radius Length

Nomenclature For Vertical Curves

G_1 & G_2	Tangent Grade in percent
A	The absolute of the Algebraic difference in grades in percent
BVC	Beginning of Vertical Curve
EVC	End of Vertical Curve
VPI	Vertical Point of Intersection
L	Length of vertical curve
D	Horizontal distance to any point on the curve from BVC or EVC
E	Vertical distance from VPI to curve
e	Vertical distance from any point on the curve to the tangent grade
K	Distance required to achieve a 1 percent change in grade
L_1	Length of a vertical curve which will pass through a given point
D_0	Distance from the BVC to the lowest or highest point on curve
X	Horizontal distance from P' to VPI
H	A point on tangent grade G_1 to vertical position of point P'
P and P'	Points on tangent grades

Symmetrical Vertical Curve Equations

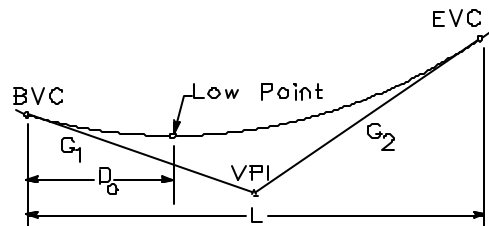

$$A = (G_2) - (G_1)$$

$$E = \frac{AL}{800}$$

$$E = \frac{1}{200} \frac{A(\text{Elev. BVC} + \text{Elev. EVC})}{2} - \text{Elev. VPI}$$

$$e = \frac{4ED^2}{L^2}$$

Notes: All equations use units of length (not stations or increments)

The variable **A** is expressed as an absolute in percent (%)

Example: If $G_1 = +4\%$ and $G_2 = -2\%$
Then **A** = 6

Symmetrical Vertical Curve Equations (cont.)

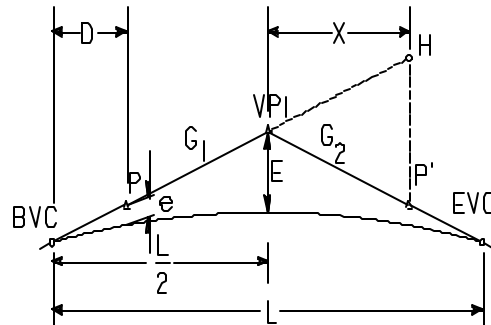

$$e = \frac{AD^2}{200L}$$

$$L_1 = \frac{2(Ax + 200e + 20\sqrt{AXe + 100e^2})}{A}$$

$$D_0 = |G_1| \frac{L}{A}$$

$$X = \frac{100(\text{Elev}_H - \text{Elev}_{P'})}{A}$$

$$K = \frac{L}{A}$$

Nomenclature For Nonsymmetrical Vertical Curves

G₁ & G₂	Tangent Grades in percent
A	The absolute of the Algebraic difference in grades in percent
BVC	Beginning of Vertical Curve
EVC	End of Vertical Curve
VPI	Vertical Point of Intersection
I₁	Length of first section of vertical curve
I₂	Length of second section of vertical curve
L	Length of vertical curve
D₁	Horizontal distance to any point on the curve from BVC towards the VPI
D₂	Horizontal distance to any point on the curve from EVC towards the VPI
e₁	Vertical distance from any point on the curve to the tangent grade between BVC and VPI
e₂	Vertical distance from any point on the curve to the tangent grade between EVC and VPI
E	Vertical distance from VPI to curve

Determining Radii of Sharp Curves by Field Measurements

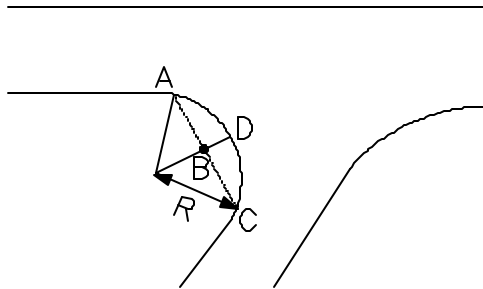

$$R = \frac{BC^2}{2BD} + \frac{BD}{2}$$
$$BC = \frac{AC}{2}$$

Note: Points A and C may be any two points on the curve

Example:

Measure the chord length from A to C

$$AC = 18.4 \quad \text{then} \quad BC = 9.2$$

Measure the middle ordinate length B to D

$$BD = 3.5$$

$$R = \frac{9.2^2}{7.0} + \frac{3.5}{2} = 13.8$$

Distance From Finished Shld. to Subgrade Shld. and Slope Equivalents

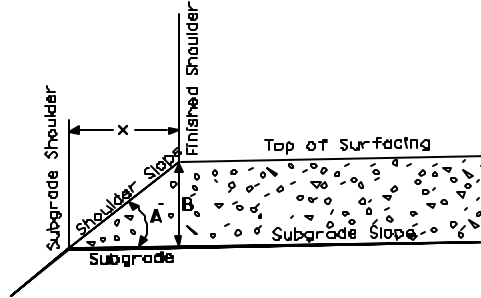

$$\text{Equation: } x = \frac{100B}{A}$$

A = Algebraic difference in % between shld. slope and subgrade slope

B = Depth of surfacing at finished shoulder

x = Distance from finished shld. to subgrade shld.

Shoulder Slope	Equivalent Rate of Grade	Equivalent Vertical Angle
1:1.5	66.67%	33°41'24"
1:1.75	57.14%	29°44'42"
1:2	50.00%	26°33'54"
1:2.5	40.00%	21°48'05"
1:3	33.33%	18°26'06"
1:4	25.00%	14°02'10"
1:5	20.00%	11°18'36"
1:6	16.67%	9°27'44"
1:8	12.50%	7°07'30"
1:10	10.00%	5°42'38"

Subgrade Slope	Equivalent Rate of Grade	Equivalent Vertical Angle
.020 / 1	2.00%	1°08'45"
.025 / 1	2.50%	1°25'56"
.030 / 1	3.00%	1°43'06"
.035 / 1	3.50%	2°00'16"
.040 / 1	4.00%	2°17'26"
.050 / 1	5.00%	2°51'45"

Areas of Plane Figures Nomenclature

A = Area

h = Height

R = Radius

P = Perimeter

Triangle

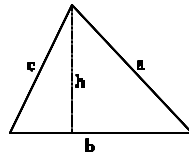

$$A = \frac{bh}{2}$$

$$P = a + b + c$$

Circle

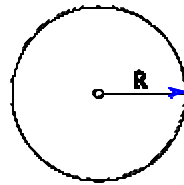

$$A = \pi R^2$$

$$P = 2\pi R$$

Ellipse

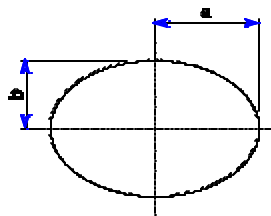

$$A = \pi ab$$

Areas of Plane Figures

Segment

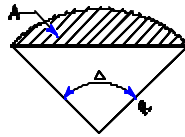

$$A = pR^2 \frac{D}{360^0} - \frac{R^2 \sin D}{2}$$

Sector

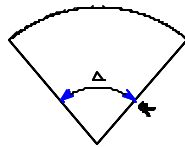

$$A = \pi R^2 \frac{\Delta}{360^0}$$

$$P = 2R + \frac{\Delta}{360^0} (2\pi R)$$

Fillet

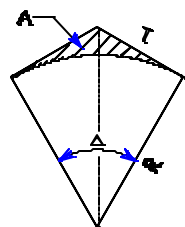

$$A = RT - \frac{\pi D \delta}{360^0 \theta} pR^2$$

$$\text{When: } D = 90^0, A = 0.2146R^2$$

Areas of Plane Figures

Parallelogram

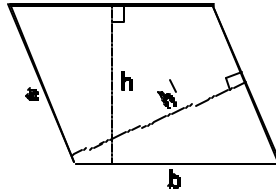

$$A = bh$$

$$A = ah'$$

$$P = 2(a + b)$$

Trapezoid

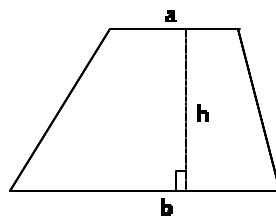

$$A = \frac{(a + b)h}{2}$$

Polygon

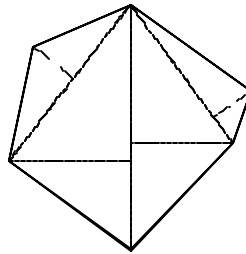

Divide into triangles
 $A = \text{Sum of all triangles}$

Areas of Plane Figures

Annulus (Circular Ring)

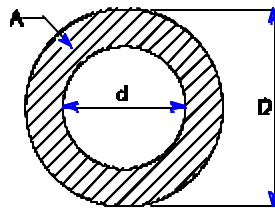

$$A = \frac{\pi}{4} (D^2 - d^2)$$

Irregular Figure

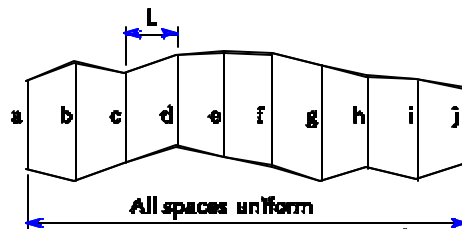

$$A = L \left[\frac{a+j}{2} + b + c + d + e + f + g + h + i \right]$$

Surfaces\Volumes of Solids

Nomenclature

- S** Lateral surface area
 - V** Volume
 - A** Area of section perpendicular to sides
 - B** Area of base
 - P** Perimeter of base
 - P_A** Perimeter of section perpendicular to its sides
 - R** Radius of sphere or circle
 - L** Slant height or lateral length
 - H** Perpendicular Height
 - C** Circumference of circle or sphere
-

Parallelepiped

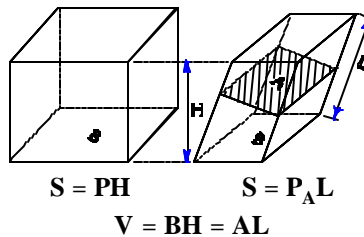

Pyramid or Cone Right or Regular

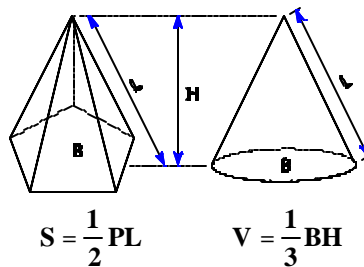

Surfaces/Volumes of Solids

Pyramid or Cone, Right or Oblique, Regular or Irregular

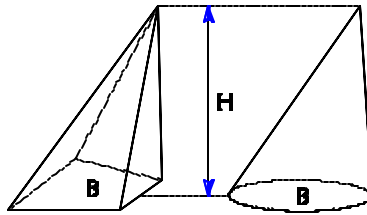

$$V = \frac{1}{3}BH$$

Prism: Right or Oblique, Regular or Irregular

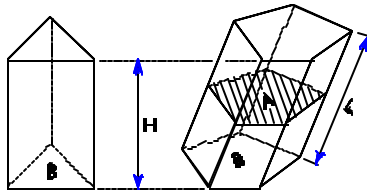

$$S = PH = P_A L$$

$$V = BH = AL$$

Cylinder: Right or Oblique, Circular or Elliptic

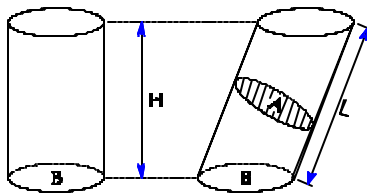

$$S = PH = P_A L$$

$$V = BH = AL$$

Surfaces/Volumes of Solids

Frustum of any Prism or Cylinder

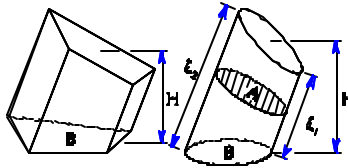

$$V = BH \qquad V = \frac{1}{2}A(L_2 + L_1)$$

Frustum of Pyramid or Cone Right and Regular, Parallel Ends

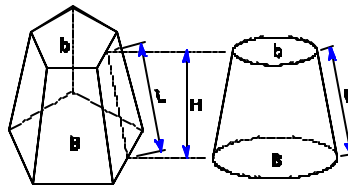

$$S = \frac{1}{2}L(P + p) \qquad V = \frac{1}{3}H(B + b + \sqrt{Bb})$$

p = perimeter of top b = area of top

Frustum of any Pyramid or Cone, with Parallel Ends

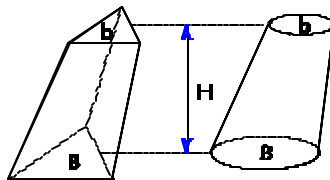

$$V = \frac{1}{3}H(B + b + \sqrt{Bb})$$

b = area of top

Surfaces/Volumes of Solids

Sphere

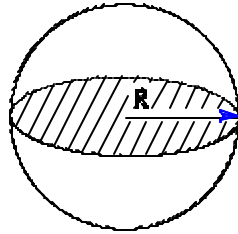

$$S = 4\pi R^2 \quad V = \frac{4}{3}\pi R^3$$

Spherical Sector

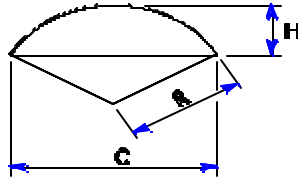

$$S = \frac{1}{2}\pi R(4H + C) \quad V = \frac{2}{3}\pi R^2 H$$

Spherical Segment

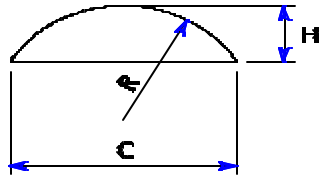

$$S = 2\pi R H = \frac{1}{4}\pi(4H^2 + C^2)$$

$$V = \frac{1}{3}\pi H^2(3R - H)$$

Surfaces/Volumes of Solids

Spherical Zone

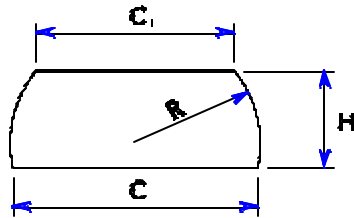

$$S = 2\pi RH$$

$$V = \frac{1}{24}\pi H(3C_1^2 + 3C^2 + 4H^2)$$

Circular Ring

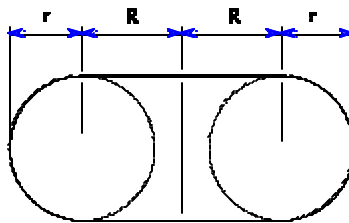

$$S = 4\pi^2 Rr$$

$$V = 2\pi^2 Rr^2$$

Prismoidal Formula

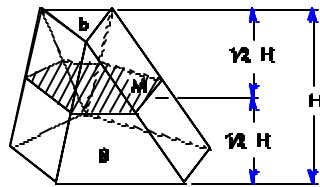

$$V = \frac{H}{6}(B + b + 4M)$$

M = Area of section parallel to bases,
Midway between them

b = area of top

Signs of Trigonometric Functions for All Quadrants

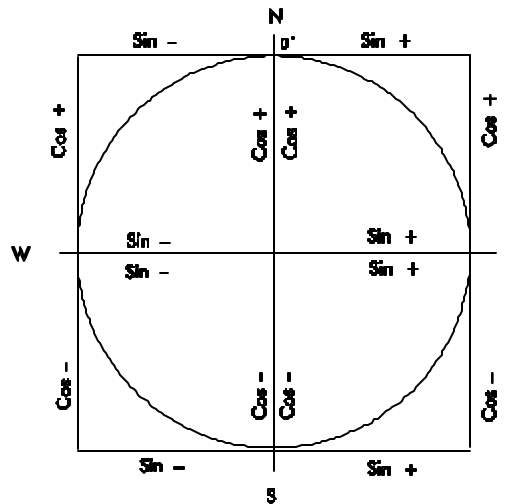

Note:

When using a calculator to compute trigonometric functions from North Azimuths, the correct sign will be displayed

Trigonometric Functions

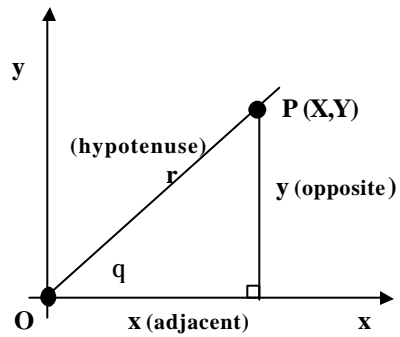

Sine	$\text{Sin } q = \frac{y}{r} = \frac{\text{opposite}}{\text{hypotenuse}}$
Cosine	$\text{cos } q = \frac{x}{r} = \frac{\text{adjacent}}{\text{hypotenuse}}$
Tangent	$\text{tan } q = \frac{y}{x} = \frac{\text{opposite}}{\text{adjacent}}$
Cotangent	$\text{cot } q = \frac{x}{y} = \frac{\text{adjacent}}{\text{opposite}}$
Secant	$\text{sec } q = \frac{r}{x} = \frac{\text{hypotenuse}}{\text{adjacent}}$
Cosecant	$\text{csc } q = \frac{r}{y} = \frac{\text{hypotenuse}}{\text{opposite}}$
Reciprocal Relations	$\sin q = \frac{1}{\text{csc}}$ $\tan q = \frac{1}{\text{cot } q}$ $\cos q = \frac{1}{\text{sec}}$
Rectangular	$X = r \times \cos q$ $y = r \times \sin q$
Polar	$r = \sqrt{x^2 + y^2}$ $q = \arctan \frac{y}{x}$

Right Triangles

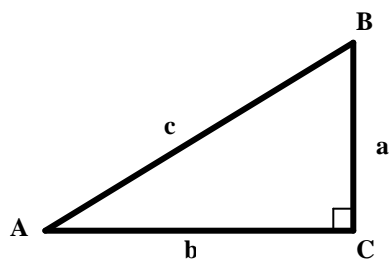

$A+B+C=180^0$		$K=Area$
Pythagorean Theorem		$a^2 + b^2 = c^2$
A and B are complementary angles		
$\sin A = \cos B$		$\tan A = \cot B$
$\cos A = \sin B$		$\sec A = \csc B$
		$\cot A = \tan B$
		$\csc A = \sec B$
Given	To Find	Equation
a, c	A, B, b, K	$\sin A = \frac{a}{c}$ $\cos B = \frac{a}{c}$ $b = \sqrt{c^2 - a^2}$ $K = \frac{a}{2} \sqrt{c^2 - a^2}$
a, b	A, B, c, K	$\tan A = \frac{a}{b}$ $\tan B = \frac{b}{a}$ $c = \sqrt{a^2 + b^2}$ $K = \frac{ab}{2}$
A, a	B, b, c, K	$B = 90^0 - A$ $b = a \times \cot A$ $c = \frac{a}{\sin A}$ $k = \frac{a^2 \times \cot A}{2}$
A, b	B, a, c, K	$B = 90^0 - A$ $a = b \times \tan A$ $c = \frac{b}{\cos A}$ $K = \frac{b^2 \times \tan A}{2}$
A, c	B, a, b, K	$B = 90^0 - A$ $a = c \times \sin A$ $b = c \times \cos A$ $K = \frac{c^2 \times \sin 2A}{4}$

Oblique Triangles

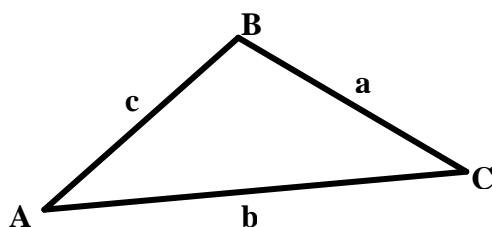

Law of Sines	$\frac{a}{\sin A} = \frac{b}{\sin B} = \frac{c}{\sin C}$	
Law of Cosines	$a^2 = b^2 + c^2 - 2bc \times \cos A$ $b^2 = a^2 + c^2 - 2ac \times \cos B$ $c^2 = a^2 + b^2 - 2ab \times \cos C$	
Sum of Angles	$A + B + C = 180^\circ$	
K = Area	$s = \frac{a + b + c}{2}$	
Given	To Find	Equation
a, b, c	A	$\sin \frac{A}{2} = \sqrt{\frac{(s-b)(s-c)}{bc}}$ $\cos \frac{A}{2} = \sqrt{\frac{s(s-a)}{bc}}$ $\tan \frac{A}{2} = \sqrt{\frac{(s-b)(s-c)}{s(s-a)}}$

Oblique Triangles

Given	To Find	Equation
a, b, c	B	$\sin \frac{B}{2} = \sqrt{\frac{(s-a)(s-c)}{ac}}$ $\cos \frac{B}{2} = \sqrt{\frac{s(s-b)}{ac}}$ $\tan \frac{B}{2} = \sqrt{\frac{(s-a)(s-c)}{s(s-b)}}$
a, b, c	C	$\sin \frac{C}{2} = \sqrt{\frac{(s-a)(s-b)}{ab}}$ $\cos \frac{C}{2} = \sqrt{\frac{s(s-c)}{ab}}$ $\tan \frac{C}{2} = \sqrt{\frac{(s-a)(s-b)}{s(s-c)}}$
a, b, c	K	$K = \sqrt{s(s-a)(s-b)(s-c)}$
a, A, B	b, c	$b = \frac{a \times \sin B}{\sin A} \quad c = \frac{a \times \sin(A+B)}{\sin A}$
a, A, B	K	$K = \frac{ab \times \sin C}{2} = \frac{a^2 \times \sin B \times \sin C}{2 \times \sin A}$
a, b, A	B	$\sin B = \frac{b \times \sin A}{a}$
a, b, A	c	$c = \frac{a \times \sin C}{\sin A} = \frac{b \times \sin C}{\sin B}$ $c = \sqrt{a^2 + b^2 - 2ab \times \cos C}$
a, b, A	K	$K = \frac{ab \times \sin C}{2}$
a, b, C	A	$\tan A = \frac{a \times \sin C}{b - a \times \cos C}$
a, b, C	c	$c = \frac{a \times \sin(A+B)}{\sin A}$ $c = \sqrt{a^2 + b^2 - 2ab \times \cos C}$
a, b, C	K	$K = \frac{ab \times \sin C}{2}$

Conversion Factors

Class	multiply:	by:	to get:
Length	in	0.0833	ft
	in	0.028	yd
	ft	12	in
	ft	0.33	yd
	ft	0.06	rods
	yd	36	in
	yd	3	ft
	yd	0.18	rods
	rods	198	in
	rods	16.5	ft
	rods	5.5	yd
	mi	5280	ft
	mi	1760	yd
	mi	320	rods
Area	in ²	0.007	ft ²
	ft ²	144	in ²
	ft ²	0.11	yd ²
	yd ²	1296	in ²
	yd ²	9	ft ²
	yd ²	0.03	rods ²
	rods ²	272.25	ft ²
	rods ²	30.25	yd ²
	acres	43560	ft ²
	acres	4840	yd ²
	acres	160	rods ²

Conversion Factors

Class	multiply:	by:	to get:	
Volume	ft ³	1728	in ³	
	ft ³	0.04	yd ³	
	ft ³	7.48	gallons	
	yd ³	27	ft ³	
	yd ³	202	gallons	
	quarts	2	pints	
	quarts	0.25	gallons	
	gallons	8	pints	
	gallons	4	quarts	
	gallons	0.13	ft ³	
	Force	ounces	0.06	pounds
		pounds	16	ounces
tons (short)		2000	pounds	
tons (metric)		2205	pounds	
Velocity	miles/hr	88	ft/min	
	miles/hr	1.47	ft/sec	

Metric Conversion Factors

Class	multiply:	by:	to get:
Length	in	25.40	mm
	in	2.540	cm
	in	0.0254	m
	ft	0.3048	m
	yd	0.9144	m
	mi	1.6093	km
Area	ft ²	0.0929	m ²
	yd ²	0.8361	m ²
	mi ²	2.590	km ²
Volume	in ³	16.387	cm ³
	ft ³	0.0283	m ³
	yd ³	0.7646	m ³
	gal	3.785	L
	gal	0.0038	m ³
	fl oz	29.574	mL
	acre ft	1233.48	m ³
Mass	oz	28.35	g
	lb	0.4536	kg
	kip (1000 lb)	0.4536	metric ton (1000 kg)
	short ton 2000 lb	907.2	kg
	short ton	0.9072	metric ton

Land Surveying Conversion Factors

Class	multiply:	by:	to get:
Area	acre	4046.8726	m ²
	acre	0.40469	ha 10000 m ²
Length	ft	12/39.37*	m

* Exact, by definition of the U.S. Survey foot

Steel Tape Temperature Corrections

$$C = 11.66 \cdot 10^{-6} (T_C - 20) L_m$$

or

$$C = 6.45 \cdot 10^{-6} (T_F - 68) L_f$$

Where:

- C** = Correction
- T_C** = Temperature in degrees Celsius
- L_M** = Length in meters
- T_F** = Temperature in degrees Fahrenheit
- L_f** = Length in feet

Temperature Conversion

Fahrenheit to Celsius $\frac{5}{9} (^{\circ}\text{F} - 32)$

Celsius to Fahrenheit $\left(\frac{9}{5} ^{\circ}\text{C}\right) + 32$

Less Common Conversion Factors

Class	multiply:	by:	to get:
Density	lb/ft ³	16.0185	kg/m ³
	lb/yd ³	0.5933	kg/m ³
Pressure	psi	6894.8	Pa
	ksi	6.8948	MPa
	lb/ft ²	47.88	Pa
Velocity	ft/s	0.3048	m/s
	mph	0.4470	m/s
	mph	1.6093	km/h

Water Constants

Freezing point of water = 0° C (32° F)
 Boiling point of water under pressure of one atmosphere = 100° C (212° F)
 The mass of one cu. meter of water is 1000 kg
 The mass of one liter of water is 1 kg (2.20 lbs)
 1 cu. ft. of water @60° F = 62.37 lbs (28.29 kg)
 1 gal of water @60° F = 8.3377 lbs (3.78 kg)

Cement Constants

1 sack of cement (appx.) = 1 ft³ = 0.028 m³
 1 sack of cement = 94 lbs. = 42.64 kg
 1 gallon water = 8.3453 lbs. @39.2° F
 1 gallon water = 3.7854 kg @4° C

Multiplication Factor Table

Multiple	Prefix	Symbol
1 000 000 000 = 10 ⁹	giga	G
1 000 000 = 10 ⁶	mega	M
1 000 = 10 ³	kilo	k
100 = 10 ²	*hecto	h
10 = 10 ¹	*deka	da
0.1 = 10 ⁻¹	*deci	d
0.01 = 10 ⁻²	*centi	c
0.001 = 10 ⁻³	milli	m
0.000 001 = 10 ⁻⁶	micro	μ
0.000 000 001 = 10 ⁻⁹	nano	n

* Avoid when possible

Recommended Pronunciations

Prefix	Pronunciation
giga	jig'a (i as in <i>jig</i> , a as in <i>a</i> -bout)
mega	as in <i>mega</i> -phone
kilo	kill' oh
hecto	heck' toe
deka	deck' a (a as in <i>a</i> -bout)
centi	as in <i>centi</i> -pede
milli	as in <i>mili</i> -tary
micro	as in <i>micro</i> -phone
nano	nan' oh

Reinforcing Steel

Bar Size	Nominal Diameter	Nominal Area	Unit Weight
#3	9.5mm [0.375 in]	71mm ² [0.110 in ²]	0.560kg\m [0.376 lb\ft]
#4	12.7mm [0.500 in]	127mm ² [0.197 in ²]	0.994kg\m [0.668 lb\ft]
#5	15.9mm [0.625 in]	199mm ² [0.309 in ²]	1.552kg\m [1.043 lb\ft]
#6	19.1mm [0.750 in]	287mm ² [0.445 in ²]	2.235kg\m [1.502 lb\ft]
#7	22.2mm [0.875 in]	387mm ² [0.600 in ²]	3.045kg\m [2.044 lb\ft]
#8	25.4mm [1.000 in]	507mm ² [0.786 in ²]	3.973kg\m [2.670 lb\ft]
#9	28.7mm [1.128 in]	647mm ² [1.003 in ²]	5.060kg\m [3.400 lb\ft]
#10	32.3mm [1.270 in]	819mm ² [1.270 in ²]	6.404kg\m [4.303 lb\ft]
#11	35.8mm [1.410 in]	1007mm ² [1.561 in ²]	7.907kg\m [5.313 lb\ft]
#14	43.0mm [1.693 in]	1452mm ² [2.251 in ²]	11.384kg\m [7.650 lb\ft]
#18	57.3mm [2.257 in]	2579mm ² [3.998 in ²]	20.239kg\m [13.600 lb\ft]

Notes

Notes

A

- AAH Administrative Roles and Responsibilities, 6-26
- Abandoned Cargo, 1-5
- Abandoned or Illegally Parked Vehicles, 7-7
- Abutments, Bulkheads, Piers, and Intermediate Bents., 5-3
- Acronyms and Abbreviations, 11
- Administration and Logistics, 1-2
- Adopt-a-Highway, 6-23
- Advance warning, 2-2
- Aggregate, 3-16
- Aggregate (Chip) Seal, 3-14
- Agreed Upon Guidelines, 1-2
- Alligator Cracking, 3-2
- Application, 8-6
- Application of Asphalt, 3-22
- Aquatic Pesticide Applications, 6-17
- Asphalts and Emulsions, 3-15
- Asphalt Emulsion Surface Treatment, 3-14
- Asphalt Wearing Surface., 5-3
- Assignment of Sections, 6-24
- Automatic Pumps, 4-4
- Auxiliary Facilities, 6-27

B

- Bank Protection, 4-5
- Betterments - Pavement Markings, 1-3
- Bicycle Control, 2-10
- Biological Control, 6-19
- Blade Mixed Asphalt Mix, 3-27
- Bridge Drains., 5-3
- Bridge Information, 5-5
- Bridge Repair Guidelines, 5-4
- Budget, 10-9
- Buffer space, 2-3
- Burning Debris, 6-20

C

- Calibration Procedures, 3-17
- Changeable message signs, 2-4
- Changeable Message Sign Systems, 9-1
- Channelizing Devices, 2-4
- Checking the Bitumeter, 3-22
- Chip Spreader, 3-24
- Chip spreader Calibration, 3-23
- City/State Maintenance Responsibilities For City Streets As Part Of The State Highway System, 1-5

City/State Maintenance Responsibilities Of Bridges That
Convey Non-Limited Access State Highways That Are Also City Streets, 1-7
City Streets as Part of State Highways, 1-1, 1-2
City Streets on the State Highway System, 7-6
Cleaning of Distributor, 3-21
Closures, 7-7
Cold Pour Method, 3-10
Common Types of Emulsions Used for Chip Seals, 3-15
Concepts of Operations, 1-2
Concrete Deck., 5-3
Concurrences, 1-9
Concurrences with Recommendations for Acceptance, 1-9
Cone Placement Procedure, 2-5
Container Disposal, 6-17
Crack Sealing (or Pouring), 3-10
Cultural Control Methods, 6-19
Culverts, 4-3
Curbs and Railings, 5-3

D

Danger Trees, 6-13
Definitions, 6-1, 6-21
Delineation, 8-5
Detention Ponds and Tanks, 4-5
Devices, 2-7
Disposal of Logs Dumped on Right of Way, 6-13
Disposal of Surplus Items, 10-8
Distributor, 3-16
Distributor Calibrations, 3-17
Ditches and Gutters, 4-2
Documentation, 9-1
DOs of Seal Coating, 3-26
DO NOTs of Seal Coating, 3-27
Drainage, 4-1
Drainage from Abutting Properties, 4-1
Drain Pump Systems, 9-2
Dry Wells, 4-3

E

Edge Raveling, 3-4
Effects of Traffic on a Patching Operation, 3-9
Electrical System Maintenance, 9-1
Emergency Assistance, 7-8
Emergency Operating Procedures, 1-3
Emergency Procedures, 1-1
Enclosure Maintenance, 9-1
Encroachment- Maintenance Crew Responsibilities, 6-14
Encroachments- General, 6-14
Enforcement, 2-12
Environmental Aspects, 5-5

Environmental Sensitivity, 10-10
Equipment, 10-8, 3-16
Expansion Joints., 5-3

F

First Priority, 6-12
Flushing, 3-4
Fog Seals, 3-14
Franchises and Permits, 6-15
Functional Zone Objectives, 6-7
Fundamental Principles, 2-1

G

Gate and Barrier Systems, 9-2
General, 3-1, 4-1, 5-1, 6-1, 7-1, 8-1, 9-1
General Conditions., 5-3
General Permits for Roadside Enhancement, 6-26
General Technique, 10-8
Grader Patching, 3-8
Grid Decks., 5-3
Guardrail (Barriers) Maintenance, 1-3
Guideposts, 8-8

H

Handling Emulsified Asphalts, 3-28
Hand Signaling Devices, 2-7
Helpful Reminders, 10-8
Highway Categories, 7-3
Historical Markers, 6-28
Hot Pour Method, 3-10

I

Illegal Tree Removal, 6-20
Illumination Systems, 9-2
Impact Attenuators, 8-10
Inspection, 5-1, 8-8
Instructions for Radio Operation, 10-8
Integrated Vegetation Management, 6-10
Intersection Control Beacons(Includes Hazard Beacons), 9-2
Inventoried Items, 10-8
Islands, 8-11

L

Litter Control and Partnerships for Roadside Enhancement, 6-22
Load & Speed Restrictions, 3-2
Longitudinal Cracking, 3-3
Lowest Priority, 6-13

M

- Maintenance, 8-3, 8-8, 8-10, 8-11
- Maintenance & Operations Responsibilities, 6-26
- Maintenance Field Personnel, 1-4
- Maintenance Involvement in the Roadside Management Process, 6-4
- Maintenance of Flexible Pavements, 3-2
- Maintenance of Rigid Pavements, 3-11
- Maintenance of Structures, 5-1
- Maintenance of Zone 1, 6-8
- Maintenance of Zone 2, 6-9
- Maintenance of Zone 3, 6-10
- Maintenance Superintendent or Supervisor, 1-4
- Maintenance Yards, 10-6
- Major, 9-2
- Major Structures, 5-1
- Marking Renewal or Replacement Frequency, 8-7
- Materials, 8-6
- Materials from State Quarries or Pits, 10-7
- Material Selection, 3-15
- Material Specifications-General, 10-7
- Methods, 6-8, 6-9, 6-10, 6-11
- Minor, 9-2
- Minor Structures, 5-1
- Miscellaneous, 10-1

N

- Nighttime Activities, 2-9
- Non-Inventoried Items, 10-8
- Non-motorized Traffic Control, 2-10
- Notification, 6-21
- Noxious Weed Control, 6-12
- Nozzle Size, 3-18

O

- Off-Road Activities, 2-9
- Oil Separators, 4-6
- Organization and Assignment of Responsibilities, 1-2
- Other Cutting Methods, 6-19
- Overlay Patches, 3-6

P

- Paint., 5-3
- Parallel Ditches and Cross Culverts, 1-3
- Park and Ride Lots, 6-28
- Participant Eligibility, 6-23
- Patching, 3-4
- Patching with Base Repair, 3-4
- Pavement Conditions for a Successful Project, 3-15
- Pavement Deficiencies, 3-2

Pavement Maintenance Techniques, 3-4
Pavement Markings, 8-5
Pedestrian Control, 2-10
Pedestrian Detection and Display System, 9-3
Pesticide License, 6-16
Pesticide Sensitive Individuals, 6-17
Plan Development and Maintenance, 1-3
Policy, 6-10
Portland Cement Concrete Pavement Crack Pouring, 3-11
Post-Seal Inspection, 3-26
Posting Requirements, 6-17
Potholes, 3-3
Precautions, 7-9
Preparation for Winter Operations, 7-1
Procurement of Materials, 10-7
Product Labels, 6-16
Program Rules, 6-23
Proper Nozzle Angle, 3-21
Proper Pressure, 3-18

R

Raveling & Pitting, 3-3
Recommendations Accepted, 1-9
Reconstruction Principles, 8-1
Record Keeping, 6-16
Reference, 6-2
Regional Emergency Response Plans, 1-2
Region Responsibilities, 6-27
Removal of Dangerous Objects and Structures, 6-14
Removal of Debris and Rubbish, 6-22
Removal of Markings, 8-7
Repair, 8-8
Reporting, 10-10
Resources, 6-2
Right of Way Fences, 10-1
Roadside Functions, 6-3
Roadside Maintenance and the Maintenance
Accountability Process, 6-4
Roadside Management, 6-1
Roadside Management Zones, 6-5
Roadside Treatment, 6-4
Roadway Illumination Systems, 9-2
Roadway Preparation, 3-16
Road Approaches- General, 10-1
Rockfall Ditches and Slope Benches, 4-3
Rolling, 3-25
Rolling Hot Mix Patches, 3-8
Rutting, 3-2

S

- Safety, 2-1
- Safety Rest Areas, 6-27
- Sags and Humps, 3-4
- Sand Seal, 3-14
- Scheduling, 10-9
- Second Priority, 6-12
- Services, 9-3
- Service Level Quality Measurement, 7-9
- Signal Control Systems, 9-4
- Signal Systems, 9-3
- Significant Roadside Activities, 6-20
- Signing, 8-2
- Signing Responsibility, 8-2
- Signs and Supports, 2-3
- Sign Installation, 8-2
- Sign Lighting Systems, 9-3
- Sign Storage and Transportation, 8-4
- Sign Visibility, 8-4
- Snow and Ice Control, 7-1
- Snow Plowing, 1-4
- Special Criteria, 7-4
- Sponsored Adoptions, 6-25
- Spray Bar Height, 3-20
- Spreader Box Patching, 3-7
- Spreading Aggregate, 3-23
- Spreading of Fines or Choking - Optional, 3-25
- Sprinkler Systems, 9-4
- Standard Run of Barrier, 8-9
- State Owned Bridges That Convey City Or County Traffic Over A Limited Access Or Non-Limited Access Highway Corridor, 1-8
- Steel Truss Members., 5-3
- Stockpile Sites, 10-6
- Storm Sewers, 4-4
- Streaking Will Occur:, 3-21
- Stringers, Caps, and Floor Beams., 5-3

T

- Television Systems, 9-4
- Terminals and Anchors, 8-9
- The Use of Pesticides, 6-16
- Traffic Barriers and Impact Attenuators, 8-8
- Traffic Control, 3-22
- Traffic Control Devices, 2-3
- Traffic Control Procedures, 2-8
- Traffic Control Zones, 2-2
- Traffic Services, 8-1
- Training and Exercises, 1-3
- Transitions, 8-10

Transit Vehicle Stop Zones, 8-11
Transverse Cracking, 3-3
Trespass and Encroachment, 6-14
Tunnels., 5-4
Typical Maintenance Responsibilities in Cities, 10-1
Typical Roadside Management Zones, 6-7

U

Under Drains, 4-4
Use of Mowing Equipment, 6-18
Utility Installations, 5-7

V

Vehicle Detection Systems, 9-3
Vehicle Display Systems, 9-3
Viewpoints, 6-29
Volunteer Adoptions, 6-24

W

Walls and Cribbing., 5-4
Waterways., 5-3
Water and Concrete Barriers, 2-6
Weather, 3-16
Wiring and Connection Maintenance, 9-1
Wood Truss Members, 5-3
Work on Other Roads and Areas, 7-6
Work on State Highways, 7-4
Work Scheduling and Reporting, 10-9
Work Zone Safety, 2-12
WSDOT Disaster Plan, 1-2

